

Plug AM-TOP® - Part no. 288

- screw terminals
- single part body
- cable gland and sealing
- strain relief and protection against kinking

| | |
|-----------------------|-----------------|
| Protection type | IP 67 |
| Ampere | 16 A |
| Poles | 5p |
| Voltage | 400 |
| Hertz | 50-60Hz |
| Earth position | 6h |
| Contact | standard |
| Connection technology | Screw terminals |

Std. Pack. 10 Qty.

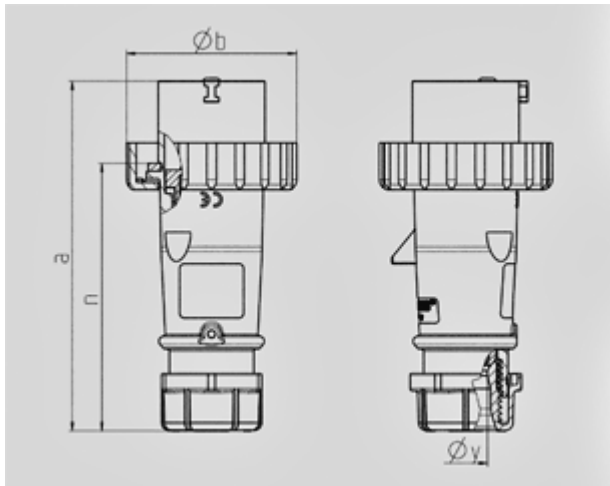

| Drawing | Amp. | 16 | | | 32 | | |
|--------------------------------------|------|-------|------|------|-------|-----|-----|
| | | Poles | | | Poles | | |
| 2 MB 218 | | 3 | 4 | 5 | 3 | 4 | 5 |
| Dim. in mm | a | 142 | 144 | 147 | 186 | 186 | 180 |
| | b | 70 | 78 | 87 | 94 | 94 | 101 |
| | n | 109 | 111 | 114 | 145 | 145 | 138 |
| | y | 14,5 | 16 | 16 | 22 | 22 | 22 |
| Terminal for cond. cross | | 1 | 1 | 1 | 2,5 | 2,5 | 2,5 |
| section (mm ²) min.-max. | | -2,5 | -2,5 | -2,5 | -6 | -6 | -6 |