

**Panel mounted socket - Part no. 240A**

- screw terminals
- straight

Protection type	IP 67
Ampere	32 A
Poles	5p
Voltage	400
Hertz	50-60Hz
Earth position	6h
Contact	standard
Connection technology	Screw terminals

Std. Pack. 10 Qty.

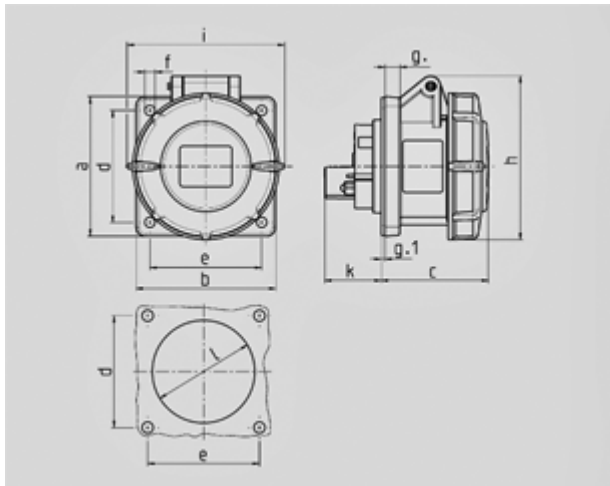

Drawing	Amp.	16			32		
		3	4	5	3	4	5
<b>1 MB 141</b>	<b>Poles</b>						
<b>Dim. in mm</b>	<b>a</b>	75	75	75	85	85	85
	<b>b</b>	75	75	75	75	75	75
	<b>c</b>	60	61	61	70	70	72
	<b>d</b>	60	60	60	60	60	60
	<b>e</b>	60	60	60	60	60	60
	<b>f</b>	5.5	5.5	5.5	5.5	5.5	5.5
	<b>g.</b>	8	8	8	8	8	8
	<b>g.1</b>	2	2	2	2	2	2
	<b>h</b>	83	88	95	99	99	105
	<b>i</b>	78	85	96	103	103	110
	<b>k</b>	31	32	32	39	39	39
	<b>l</b>	43	52	54	58	58	65
	<b>Terminal for cond. cross section (mm<sup>2</sup>) min.-max.</b>	1.5	1.5	1.5	2.5	2.5	2.5
		-4	-4	-4	-10	-10	-10