

Wall mounted socket SCHUKO® - Part no. 10083

- with hinged lid
- with 3 plug-in terminals for connection of 1.5 – 2.5 mm²
- cable entry M 20 x 1.5 at top and blind entry (for cut out) M 20 x 1.5 at bottom
- can be arranged in a row using slot and slide

Protection type	IP 44
Ampere	16 A
Poles	2p+E
Voltage	230
Contact	standard
Connection technology	Plug-in terminals

Std. Pack. 10 Qty.

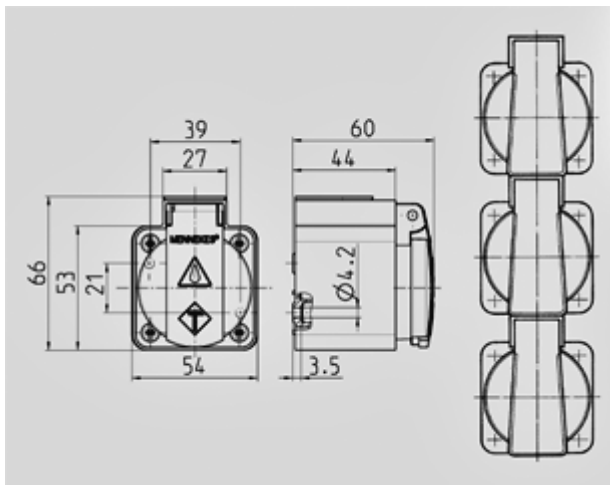

Drawing
1 MB 27/30

Dim. in mm