

Panel mounted socket - Part no. 1496

- screw terminals
- suitable for through wiring
- 20° inclination
- receptacles optional fitted with auxiliary contact

Protection type	IP 44
Ampere	32 A
Poles	4p
Voltage	400
Hertz	50-60Hz
Earth position	6h
Contact	standard
Connection technology	Screw terminals

Std. Pack. 10 Qty.

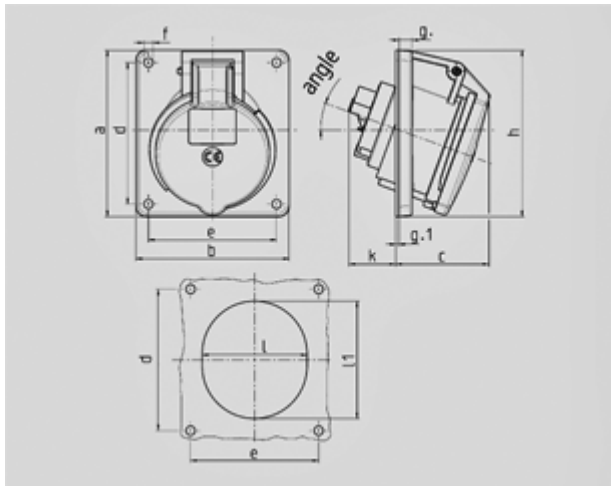

Drawing 1 MB 260	Amp. Poles	16			32		
		3	4	5	3	4	5
Dim. in mm	a	73.5	100	100	100	100	100
	b	64	92	92	92	92	92
	c	50	59	58	62	62	61
	d	60	85	85	85	85	85
	e	52	77	77	77	77	77
	f	5.5	5.5	5.5	5.5	5.5	5.5
	g-	7	8	8	8	8	8
	g.1	2	2	2	2	2	2
	h	79	100	100	103	103	106
	k	44	34	34	54	54	49
	l	52	55	65	67	67	72
	ll	60	63	72	82	82	85
	a	20°	20°	20°	20°	20°	20°
Terminal for cond. cross section (mm ²) min.-max.		1.5 —4	1.5 —4	1.5 —4	2.5 —10	2.5 —10	2.5 —10