

Cepex wall mounted socket - Part no. 4102

- screw terminals
- cable entry: 1 x M 25 with cable gland at top, 1 x M 25 to be cut out at the bottom, 1 x M 20 to be cut out at the back side, for cables 7 up to 13 mm Ø
- meeting DIN 18032 standards for ball rebound

Protection type IP 44
 Ampere 16 A
 Poles 3p
 Voltage 230
 Hertz 50-60Hz
 Earth position 6h

Std. Pack. 5 Qty.

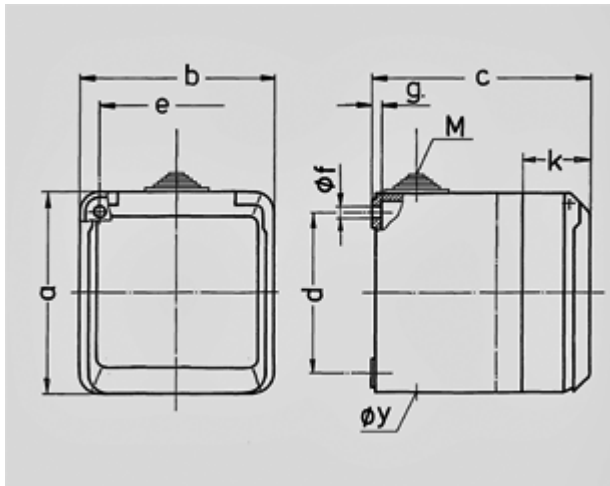

Drawing	Amp.	16			32		
		3	4	5	3	4	5
1 MB 312	Poles						
Dim. in mm	a	93	93	93	93	93	93
	b	90	90	90	90	90	90
	c	87	87	87	99	99	99
	d	75	75	75	75	75	75
	e	73	73	73	73	73	73
	f	5,5	5,5	5,5	5,5	5,5	5,5
	g	4,2	4,2	4,2	4,2	4,2	4,2
	k	33	33	33	33	33	33
	y	25,5	25,5	25,5	25,5	25,5	25,5
	M	25x1,5	25x1,5	25x1,5	25x1,5	25x1,5	25x1,5
	Terminal for cond. cross section (mm ²) min.-max.	1,5 —4	1,5 —4	1,5 —4	2,5 —6	2,5 —6	2,5 —6