



Cam switches  
CR Series



## Overview

The **CR series** includes cam switches rated from 12 to 40A (referred to category AC-21A) and with insulation voltage of 690V.

According to the highest market standards, the CR series offers IP 20 terminals protection degree and IP66 handle protection degree.

Available with different mounting systems: rear mount with screws, base mount with screws or on DIN rail and rear mount Ø 22mm (0.87") hole with locking nut.

Diagrams for every application are available: ON-OFF switches, line switches, cam switches for motor control, ammeter and voltmeter switches, multi step switches and other special diagrams can be made on request.

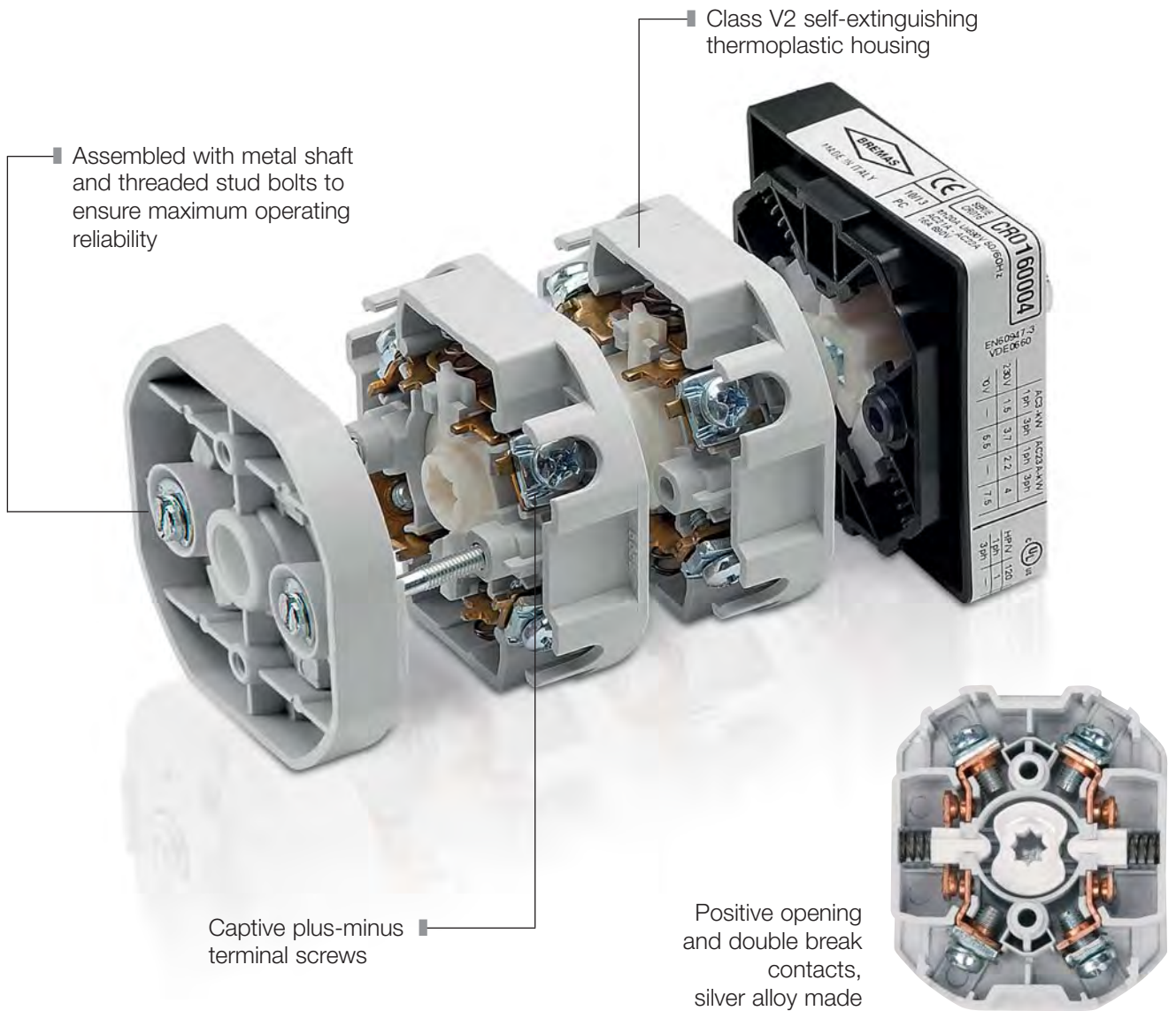

## ■ Main features

The CR series includes different amperage sizes: **12A, 16A, 20A, 25A, 32A** and **40A**

- Rated insulation voltage **690V**
- **IP20** terminals protection degree
- **IP66** handle protection degree

## ■ Base mounting

All base mounting items (BL6 - BK6 - HL6 - HK6 handles) include a 175 mm (6.89") shaft.



## ■ Improved connection capability

An additional benefit for this new release of the CR series is the improved connection capability of the terminals, that allows to use wires with larger cross-sections and eases the use of ferrules.

Maximum cross-section is now:

- CR012-020: 4 mm<sup>2</sup> solid and flex wire (AWG 12)
- CR025-040: 10 mm<sup>2</sup> solid and flex wire (AWG 8)

## ■ Customized solutions

More than 10,000 diagrams are available **upon request** to tailor every customer's need (see page 81)



**Technical data  
IEC 947-3  
EN 60947-3**

Rated insulation voltage	Ui	V
Rated operating voltage	Ue	V
Rated impulse withstand voltage	Uimp	kV
Rated thermal current for open switch	Ith	A
Rated operation frequency		Hz
Power dissipation for each pole		W
<b>Rated operating current</b>		
AC-21A Switching resistive loads, including moderate overloads	Ie	A
AC-22A Switching of mixed resistive and inductive loads, including moderate overloads	Ie	A
AC-20A Connecting and disconnecting under no load conditions		
<b>Rated operating power</b>		
AC-23A Switching of motor loads or other highly inductive loads 3 phase - 3 pole	230V	kW(A)
	400V	kW(A)
	500V	kW(A)
	690V	kW(A)
AC- 23A Switching of motor loads or other highly inductive loads 1 phase - 2 pole	110V	kW(A)
	230V	kW(A)
AC-3 Squirrel cage motors: starting, switching off motors during running 3 phase - 3 pole	230V	kW(A)
	400V	kW(A)
	500V	kW(A)
	690V	kW(A)
AC-3 Squirrel cage motors: starting, switching off motors during running 1 phase - 2 pole	110V	kW(A)
	230V	kW(A)
	400V	kW(A)
AC-4 Squirrel cage motors: starting, plugging, inching	230V	kW(A)
	400V	kW(A)
AC-15 Control of a.c electromagnetic loads	230V	A
	400V	A
Rated breaking capability in category in AC-23A (cosφ=0,45)	230V	A
	400V	A
<b>Short circuit protection</b>		
Rated short time withstand current	Icw	A
Rated short-circuit make capacity	Icm	A
Rated conditional short-circuit current		kA
With fuses class gG	500V	A

**Technical data UL**









Rated insulation voltage	UL	V
Rated operating voltage	UL	V
General use current	UL	A
<b>Rated operating power</b>		
1 phase - 2 pole	120V	Hp
	240V	Hp
3 phase - 3 pole	200V	Hp
	240V	Hp
	480V	Hp
	600V	Hp

**Mechanical characteristics**

Mechanical life		Cycles x 10 Cicles/hour	
<b>Connections according to IEC 9471-1 and EN 50947-1</b>			
Connecting capability	with flexible wires	Min-Max	mm <sup>2</sup>
		Min-Max	AWG
	with solid wires	Min-Max	mm <sup>2</sup>
Connection terminal screw dimensions			Type
Screw tightening torque			Nm
<b>Protection degree IEC 529 EN 60529</b>			
Terminals			IP
<b>Ambient conditions</b>			
Operating ambient temperature			°C
Storage ambient temperature			°C
Withstand to constant humid according to IEC 60068			
Withstand to cyclic humid according to IEC 60068			

CR012	CR016	CR020	CR025	CR032	CR040
690	690	690	690	690	690
690	690	690	690	690	690
6	6	6	6	6	6
16	20	25	32	32	40
50	50	50	50	50	50
0,27	0,5	0,4	1	1	1,3
12	16	20	25	32	40
12	16	16	20	25	32
-	-	-	-	-	-
3(9)	4(14)	5,5(17)	7,5(24)	8,5(27)	10(32)
4(9)	7,5(14)	9(16)	11(20)	15(27)	18,5(30)
-	-	9(13)	11(15)	15(22)	18,5(27)
-	-	9(9)	11(11)	15(16)	18,5(19)
0,75(8,5)	1,1(12)	1,1(5)	2,2(25)	2,2(25)	3(34)
1,5(8,5)	2,2(14)	3(17)	3,7(20)	3,7(20)	5,5(30)
2,2(7)	3,7(12)	4(13)	5,5(17)	5,5(17)	7,5(24)
3,5(7)	5,5(10)	7,5(14)	9,5(16)	10(17)	15(27)
-	-	7,5(11)	9,5(12,5)	10(14)	15(22)
-	-	7,5(8)	8,5(10)	10(10)	16(16)
0,37(4)	0,75(9)	1,1(13)	1,5(17)	1,5(17)	2,2(25)
1,1(6)	1,5(8)	2,2(12)	3(17)	3,17	4,5(25)
-	-	3,7(12)	-	-	-
-	-	1,5(4,5)	2,2(7)	2,2(7)	3(10)
-	-	2,2(2,6)	3(5,5)	3(5,5)	5,5(10)
4	6	7	8	8	10
3	4	5	6	6	8
72	112	136	192	216	256
72	112	128	160	216	240
150	240	240	400	400	500
-	-	1500	2000	2000	2000
4	4	5	10	10	10
16	20	20	35	35	50
600	600	600	600	600	600
600	600	600	600	600	600
12	16	20	25	32	40
0,5	1	1,5	2	2	3
1,5	2	3	3	3	5
1,5	2	5	5	5	7,5
2	3	5	5,5	7,5	10
3	7,5	10	10	10	15
5	7,5	10	15	15	20
2					
120					
2x1,5 -2,5	2x1,5 -2,5	2x1,5 -2,5	2x2,5-10	2x2,5-10	2x2,5-10
16/12	16/12	16/12	16/8	16/8	16/8
2x1,5-4	2x1,5-4	2x1,5-4	2x2,5-16	2x2,5-16	2x2,5-16
M3,5	M3,5	M3,5	M4	M4	M4
1	1	1	1,7	1,7	1,7
20					
-25 ÷ +55					
-30 ÷ +70					
2-78					
2-30					

## Standard IP66 handles for 2-screw or Ø22mm (0,87") single-hole fixing

Rear mount switch	Handles for screw fixing		
 <p>Rearmount, with screw fixing</p>		<b>RT4</b>	Grey plate 48x48mm, black knob
		<b>RT6</b> <sup>(1)</sup>	Grey plate 67x67 mm (2.64"x2.64"), black knob
		<b>RL6</b> <sup>(1)</sup>	Yellow plate 67x67 mm (2.64"x2.64"), red padlockable knob (max 3 padlocks)
		<b>RK6</b> <sup>(1)</sup>	Grey plate 67x67 mm (2.64"x2.64"), black padlockable knob (max 3 padlocks)
Handles with Ø22mm (0,87") single-hole and nut fixing			
 <p>Rearmount, with Ø22mm (0,87") fixing</p>		<b>GT4</b>	Grey plate 48x48mm, black knob
		<b>GT6</b>	Grey plate 67x67mm (2.64"x2.64"), black knob
		<b>GL6</b>	Yellow plate 67x67 mm (2.64"x2.64"), red padlockable knob (max 3 padlocks)
		<b>GK6</b>	Grey plate 67x67 mm (2.64"x2.64"), black padlockable knob (max 3 padlocks)
Base mount switch	Handles for screw fixing		
 <p>Base mount with screws or DIN rail fixing</p>		<b>BL6</b> <sup>(1)</sup>	Yellow plate 67x67 mm (2.64"x2.64"), red padlockable knob (max 3 padlocks),
		<b>BK6</b> <sup>(1)</sup>	Grey plate 67x67 mm (2.64"x2.64"), black padlockable knob (max 3 padlocks),
	Handles with Ø22mm (0,87") single-hole and nut fixing		
		<b>HL6</b>	Yellow plate 67x67 mm (2.64"x2.64"), red padlockable knob (max 3 padlocks),
	<b>HK6</b>	Grey plate 67x67 mm (2.64"x2.64"), black padlockable knob (max 3 padlocks),	

Possible fixing options in rear mount depend on the combination of the plate with the body of the rear mount cam-switch. All the handles are suitable for 2-screw fixing with 2 holes at 28mm (1.10") vertical distance or 2 holes at 32mm (1.26") horizontal distance.

Note: (1) On request the handle can be supplied in a 4-screw fixing version (for 4 holes at 48x48mm (1.89" x.89") distance).

### Optional handles for 2-screw or Ø22mm (0,87") single-hole fixing

Rear mount switch		Handles for screw fixing				
 Rearmount with screw fixing		<b>RT4L</b>	48x48mm (1.89"x1.89")	<b>RT6L</b> <sup>(1)</sup>	67x67 mm (2.64"x2.64")	Grey plate black padlockable knob (max 3 padlocks), IP66
		<b>RY4L</b>	48x48mm (1.89"x1.89")	<b>RY6L</b> <sup>(1)</sup>	67x67 mm (2.64"x2.64")	Yellow plate, red padlockable knob (max 3 padlocks), IP66
		<b>RRO</b>	ø 62,5 mm (2.46")			Round aluminium plate, black knob, IP40
Handles with Ø22mm (0,87") single-hole and nut fixing						
 Rearmount with Ø22mm (0,87") single-hole and nut fixing		<b>GT4L</b>	48x48mm (1.89"x1.89")	<b>GT6L</b>	67x67 mm (2.64"x2.64")	Grey plate black padlockable knob (max 3 padlocks), IP66
		<b>GY4L</b>	48x48mm (1.89"x1.89")	<b>GY6L</b>	67x67 mm (2.64"x2.64")	Yellow plate, red padlockable knob (max 3 padlocks), IP66
		<b>GRO</b>	Ø42 mm (1.66")			Round plate without legend, black knob, IP66
Base mount switch		IP66 Handles for screw fixing		IP66 Handles with Ø22mm (0,87") single-hole and nut fixing		
 Base mount with screws or DIN rail fixing		<b>BT4L</b>	48x48mm (1.89"x1.89")	<b>HT4L</b>	48x48mm (1.89"x1.89")	Grey plate black padlockable knob (max 3 padlocks), IP66
		<b>BT6L</b> <sup>(1)</sup>	67x67 mm (2.64"x2.64")	<b>HT6L</b>	67x67 mm (2.64"x2.64")	
		<b>BY4L</b>	48x48mm (1.89"x1.89")	<b>HY4L</b>	48x48mm (1.89"x1.89")	Yellow plate, red padlockable knob (max 3 padlocks), IP66
		<b>BY6L</b> <sup>(1)</sup>	67x67 mm (2.64"x2.64")	<b>HY6L</b>	67x67 mm (2.64"x2.64")	

Possible fixing options in rear mount depend on the combination of the plate with the body of the rear mount cam-switch. All the handles are suitable for 2-screw fixing with 2 holes at 28mm (1.10") vertical distance or 2 holes at 32mm (1.26") horizontal distance. Note: <sup>(1)</sup> On request the handle can be supplied in a 4-screw fixing version (for 4 holes at 48x48mm (1.89"x1.89") distance).

 standard article  
 on Request

## ■ New IP66, 4-screw or Ø22mm (0,87") single-hole fixing handles

### ■ New fixing plates

new release of the CR series allows various fixing opportunities in the rear mount versions.

In addition to the traditional 2-screw fixing options

- 2 holes at 28mm (1.10") vertical distance
  - 2 holes at 32mm (1.26") horizontal distance
- the new plates allow also 4-screw fixing layouts
- 4 holes at 36x36mm (1.42"x1.42") distance
  - 4 holes at 48x48mm (1.89"x1.89") distance (standard for CR025-040, on request for CR012-020)



■ CR012-020



■ CR025-040

### ■ A new range of handles with new fixing opportunities

A new range of IP66 handles has been developed in different sizes and fixing options:

- 4 screw fixing: 36x36mm (1.42"x1.42") and 48x48mm (1.89"x1.89") (\*)
- Ø22mm (0,87") single-hole and nut fixing

### ■ Padlockable versions

- 67x67mm (2.52"x2.52"), in yellow/red
- 67x67mm (2.52"x2.52"), in grey/black



Notes:

\* possible fixing depends on the combination of the plate with the body of the rear mount cam-switch: please, check the compatibility with the desired fixing layout.



## ■ Non padlockable versions

- 48x48mm (1.89"x1.89"),  
in silver-grey/black and yellow-red



- 64x64mm (2.52"x2.52"),  
in silver-grey/black and yellow-red



- 48x59mm (1.89"x2.32") with label holder,  
in silver-grey black





















- 64x78mm (2.52"x3.07") with label holder,  
in silver-grey black



- Versions with label holder:
  - 48x59mm (1.89"x2.32") version,  
for marking labels maximum size  
58x10x0,3mm (2.39"x0.39"x0.012")
  - 64x78mm (2.52"x3.07") version:  
for marking labels maximum size  
42x10x0,3mm (1.65"x0.27"x0.012").  
A transparent cover will fix and protect the  
label against dust and dirt.



## IP66 handles for 4-screw or Ø22mm (0,87") single-hole fixing





Rear mount switch	Handles for 4-screw fixing			
 <p>Rearmount, with screw fixing</p>		<b>RV4</b> <sup>(1)</sup>	48x48mm (1.89"x1.89")	Grey plate black padlockable knob (max 3 padlocks), IP66
		<b>RV6</b> <sup>(2)</sup>	64x64 mm (2.52"x2.52")	Grey plate black padlockable knob (max 3 padlocks), IP66
		<b>RV4-T</b> <sup>(1)</sup>	48x59mm (1.89"x2.32")	Grey plate black padlockable knob (max 3 padlocks), IP66
		<b>RV6-T</b> <sup>(2)</sup>	64x78mm (2.52"x3.07")	Grey plate black padlockable knob (max 3 padlocks), IP66
		<b>RW4</b> <sup>(1)</sup>	48x48mm (1.89"x1.89")	Yellow plate, red padlockable knob (max 3 padlocks), IP66
		<b>RW6</b> <sup>(2)</sup>	64x64 mm (2.52"x2.52")	Yellow plate, red padlockable knob (max 3 padlocks), IP66
		<b>RK5</b> <sup>(1)</sup>	67x67 mm (2.64"x2.64")	Grey plate black padlockable knob (max 3 padlocks), IP66
		<b>RL5</b> <sup>(2)</sup>	67x67 mm (2.64"x2.64")	Yellow plate, red padlockable knob (max 3 padlocks), IP66
Rear mount switch	Handles for 4-screw fixing			
 <p>Rear mount with Ø22mm (0,87") single-hole fixing</p>		<b>GV4</b>	48x48mm (1.89"x1.89")	Grey plate black padlockable knob (max 3 padlocks), IP66
		<b>GV6</b>	64x64 mm (2.52"x2.52")	Grey plate black padlockable knob (max 3 padlocks), IP66
		<b>GV4-T</b>	48x59mm (1.89"x2.32")	Grey plate black padlockable knob (max 3 padlocks), IP66
		<b>GV6-T</b>	64x78mm (2.52"x3.07")	Grey plate black padlockable knob (max 3 padlocks), IP66
		<b>GW4</b>	48x48mm (1.89"x1.89")	Yellow plate, red padlockable knob (max 3 padlocks), IP66
		<b>GW6</b>	64x64 mm (2.52"x2.52")	Yellow plate, red padlockable knob (max 3 padlocks), IP66
		<b>GK5</b>	67x67 mm (2.64"x2.64")	Grey plate black padlockable knob (max 3 padlocks), IP66
		<b>GL5</b>	67x67 mm (2.64"x2.64")	Yellow plate, red padlockable knob (max 3 padlocks), IP66

Notes: <sup>(1)</sup> suitable for 4-screw fixing (with 4 holes at 36x36mm (1.42"x1,42") distance)

<sup>(2)</sup> suitable for 4-screw fixing (with 4 holes at 36x36mm (1.42"x1,42") and 48x48mm (1,89"x1,89") distance)

<sup>(1), (2)</sup> On request, the handle can be supplied in a 2-screw fixing version with 2 holes at 28mm (1.10") vertical distance or 2 holes at 32mm (1.26") horizontal distance.

 standard article  
 on Request

Base mount switch	Handles for 4-screw fixing				
 <p data-bbox="153 826 312 909">Base mount with screws or DIN rail fixing</p>		<b>BK5</b> <sup>(1)</sup>	67x67 mm (2.64"x2.64")	Grey plate black padlockable knob (max 3 padlocks), IP66	
					<b>BL5</b> <sup>(1)</sup>
	<b>Handles with Ø22mm (0,87") single-hole and nut fixing</b>				
		<b>HK5</b>	67x67 mm (2.64"x2.64")	Grey plate black padlockable knob (max 3 padlocks), IP66	
	<b>HL5</b>				67x67 mm (2.64"x2.64")

Notes: (1) suitable for 4-screw fixing (with 4 holes at 36x36mm (1.42"x1.42") and 48x48mm (1.89"x1.89") distance).

On request, the handle can be supplied in a 2-screw fixing version with 2 holes at 28mm (1.10") vertical distance or 2 holes at 32mm (1.26") horizontal distance.

standard article  
 on Request

### Rear mounting

2-screw fixing: 28mm (1.10") V. / 32mm (1.26") H.



**RT4**



**RT6**

### Rear mounting

Ø 22mm (0,87") single hole fixing



**GT4**



**GT6**

## ■ ON-OFF switch 1 pole

Circuit diagram	Rated nom. current	Part no.		Part no.		Part no.		Part no.	
		Part no.	Pack	Part no.	Pack	Part no.	Pack	Part no.	Pack
<p>0001</p>	12A	CR0120001RT4	1	CR0120001RT6	1	CR0120001GT4	R	CR0120001GT6	R
	16A	CR0160001RT4	1	CR0160001RT6	1	CR0160001GT4	R	CR0160001GT6	R
	20A	CR0200001RT4	1	CR0200001RT6	1	CR0200001GT4	R	CR0200001GT6	R
	25A	CR0250001RT4	1	CR0250001RT6	1	CR0250001GT4	R	CR0250001GT6	R
	32A								
	40A								

## ■ ON-OFF switch 2 pole

Circuit diagram	Rated nom. current	Part no.		Part no.		Part no.		Part no.	
		Part no.	Pack	Part no.	Pack	Part no.	Pack	Part no.	Pack
<p>0002</p>	12A	CR0120002RT4	1	CR0120002RT6	1	CR0120002GT4	1	CR0120002GT6	R
	16A	CR0160002RT4	1	CR0160002RT6	1	CR0160002GT4	R	CR0160002GT6	1
	20A	CR0200002RT4	1	CR0200002RT6	1	CR0200002GT4	R	CR0200002GT6	R
	25A	CR0250002RT4	1	CR0250002RT6	1	CR0250002GT4	R	CR0250002GT6	R
	32A	CR0320002RT4	1	CR0320002RT6	1	CR0320002GT4	R	CR0320002GT6	R
	40A	CR0400002RT4	1	CR0400002RT6	1	CR0400002GT4	R	CR0400002GT6	R

## ■ ON-OFF switch 3 pole

Circuit diagram	Rated nom. current	Part no.		Part no.		Part no.		Part no.	
		Part no.	Pack	Part no.	Pack	Part no.	Pack	Part no.	Pack
<p>0003</p>	12A	CR0120003RT4	1	CR0120003RT6	1	CR0120003GT4	1	CR0120003GT6	R
	16A	CR0160003RT4	1	CR0160003RT6	1	CR0160003GT4	R	CR0160003GT6	1
	20A	CR0200003RT4	1	CR0200003RT6	1	CR0200003GT4	R	CR0200003GT6	1
	25A	CR0250003RT4	1	CR0250003RT6	1	CR0250003GT4	R	CR0250003GT6	1
	32A	CR0320003RT4	1	CR0320003RT6	1	CR0320003GT4	R	CR0320003GT6	1
	40A	CR0400003RT4	1	CR0400003RT6	1	CR0400003GT4	R	CR0400003GT6	R

standard article

R = on Request



### ■ ON-OFF switch 4 pole

Circuit diagram	Rated nom. current	Part no.		Part no.		Part no.		Part no.	
		Part no.	Pack	Part no.	Pack	Part no.	Pack	Part no.	Pack
<p>0004</p>	12A	CR0120004RT4	1	CR0120004RT6	1	CR0120004GT4	R	CR0120004GT6	R
	16A	CR0160004RT4	1	CR0160004RT6	1	CR0160004GT4	R	CR0160004GT6	1
	20A	CR0200004RT4	1	CR0200004RT6	1	CR0200004GT4	R	CR0200004GT6	R
	25A	CR0250004RT4	1	CR0250004RT6	1	CR0250004GT4	R	CR0250004GT6	R
	32A	CR0320004RT4	1	CR0320004RT6	1	CR0320004GT4	R	CR0320004GT6	R
	40A	CR0400004RT4	1	CR0400004RT6	1	CR0400004GT4	R	CR0400004GT6	R

### ■ ON-OFF switch 3 pole with spring return to "OFF"

Circuit diagram	Rated nom. current	Part no.		Part no.		Part no.		Part no.	
		Part no.	Pack	Part no.	Pack	Part no.	Pack	Part no.	Pack
<p>0035</p>	12A	CR0120035RT4	1	CR0120035RT6	1	CR0120035GT4	R	CR0120035GT6	R
	16A	CR0160035RT4	1	CR0160035RT6	1	CR0160035GT4	R	CR0160035GT6	R
	20A								
	25A								
	32A								
	40A								

### ■ Change-over switch 1 pole

Circuit diagram	Rated nom. current	Part no.		Part no.		Part no.		Part no.	
		Part no.	Pack	Part no.	Pack	Part no.	Pack	Part no.	Pack
<p>0005</p>	12A	CR0120005RT4	1	CR0120005RT6	1	CR0120005GT4	R	CR0120005GT6	R
	16A	CR0160005RT4	1	CR0160005RT6	1	CR0160005GT4	R	CR0160005GT6	R
	20A	CR0200005RT4	1	CR0200005RT6	1	CR0200005GT4	R	CR0200005GT6	R
	25A	CR0250005RT4	1	CR0250005RT6	1	CR0250005GT4	R	CR0250005GT6	R
	32A								
	40A								

standard article

R = on Request

### Rear mounting

2-screw fixing: 28mm (1.10") V. / 32mm (1.26") H.



**RT4**



**RT6**



**GT4**



**GT6**

### Rear mounting

Ø 22mm (0,87") single hole fixing

## Change-over switch 2 pole

 0006	Circuit diagram	Rated nom. current	Part no.		Part no.		Part no.		Part no.	
			Part no.	Pack	Part no.	Pack	Part no.	Pack	Part no.	Pack
 R/L1 S/L2	12A	CR0120006RT4	1	CR0120006RT6	1	CR0120006GT4	R	CR0120006GT6	R	
	16A	CR0160006RT4	1	CR0160006RT6	1	CR0160006GT4	R	CR0160006GT6	R	
	20A	CR0200006RT4	1	CR0200006RT6	1	CR0200006GT4	R	CR0200006GT6	R	
	25A	CR0250006RT4	1	CR0250006RT6	1	CR0250006GT4	R	CR0250006GT6	R	
	32A	CR0320006RT4	1	CR0320006RT6	1	CR0320006GT4	R	CR0320006GT6	R	
	40A	CR0400006RT4	1	CR0400006RT6	1	CR0400006GT4	R	CR0400006GT6	R	

## Change-over switch 3 pole

 0007	Circuit diagram	Rated nom. current	Part no.		Part no.		Part no.		Part no.	
			Part no.	Pack	Part no.	Pack	Part no.	Pack	Part no.	Pack
 R/L1 S/L2 T/L3	12A	CR0120007RT4	1	CR0120007RT6	1	CR0120007GT4	R	CR0120007GT6	R	
	16A	CR0160007RT4	1	CR0160007RT6	1	CR0160007GT4	R	CR0160007GT6	1	
	20A	CR0200007RT4	1	CR0200007RT6	1	CR0200007GT4	R	CR0200007GT6	R	
	25A	CR0250007RT4	1	CR0250007RT6	1	CR0250007GT4	R	CR0250007GT6	1	
	32A	CR0320007RT4	1	CR0320007RT6	1	CR0320007GT4	R	CR0320007GT6	R	
	40A	CR0400007RT4	1	CR0400007RT6	1	CR0400007GT4	R	CR0400007GT6	R	

## Change-over switch 4 pole

 0039	Circuit diagram	Rated nom. current	Part no.		Part no.		Part no.		Part no.	
			Part no.	Pack	Part no.	Pack	Part no.	Pack	Part no.	Pack
 R/L1 S/L2 T/L3 N/O	12A	CR0120039RT4	1	CR0120039RT6	1	CR0120039GT4	R	CR0120039GT6	R	
	16A	CR0160039RT4	1	CR0160039RT6	1	CR0160039GT4	R	CR0160039GT6	1	
	20A	CR0200039RT4	1	CR0200039RT6	1	CR0200039GT4	R	CR0200039GT6	R	
	25A	CR0250039RT4	1	CR0250039RT6	1	CR0250039GT4	R	CR0250039GT6	1	
	32A	CR0320039RT4	1	CR0320039RT6	1	CR0320039GT4	R	CR0320039GT6	R	
	40A	CR0400039RT4	1	CR0400039RT6	1	CR0400039GT4	R	CR0400039GT6	R	

standard article

R = on Request

**Rear mounting**  
2-screw fixing: 28mm (1.10") V. / 32mm (1.26") H.



**RT4**



**RT6**



**GT4**



**GT6**

**Rear mounting**  
Ø 22mm (0,87") single hole fixing

### Reversing switch 3 pole

Circuit diagram	Rated nom. current	Part no.		Part no.		Part no.		Part no.	
		Part no.	Pack	Part no.	Pack	Part no.	Pack	Part no.	Pack
 <p>0008</p>	12A	CR0120008RT4	1	CR0120008RT6	1	CR0120008GT4	1	CR0120008GT6	R
	16A	CR0160008RT4	1	CR0160008RT6	1	CR0160008GT4	R	CR0160008GT6	1
	20A	CR0200008RT4	1	CR0200008RT6	1	CR0200008GT4	R	CR0200008GT6	1
	25A	CR0250008RT4	1	CR0250008RT6	1	CR0250008GT4	R	CR0250008GT6	1
	32A	CR0320008RT4	1	CR0320008RT6	1	CR0320008GT4	R	CR0320008GT6	1
	40A	CR0400008RT4	1	CR0400008RT6	1	CR0400008GT4	R	CR0320008GT6	R

### Reversing switch 3 pole with spring return to "off"

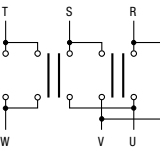
Circuit diagram	Rated nom. current	Part no.		Part no.		Part no.		Part no.	
		Part no.	Pack	Part no.	Pack	Part no.	Pack	Part no.	Pack
 <p>0036</p>	12A	CR0120036RT4	1	CR0120036RT6	1	CR0120036GT4	R	CR0120036GT6	R
	16A	CR0160036RT4	1	CR0160036RT6	1	CR0160036GT4	R	CR0160036GT6	R
	20A	CR0200036RT4	1	CR0200036RT6	1	CR0200036GT4	R	CR0200036GT6	R
	25A	CR0250036RT4	1	CR0250036RT6	1	CR0250036GT4	R	CR0250036GT6	R
	32A								
	40A								

### Changing switch Dahlander pole

Circuit diagram	Rated nom. current	Part no.		Part no.		Part no.		Part no.	
		Part no.	Pack	Part no.	Pack	Part no.	Pack	Part no.	Pack
 <p>0009</p>	12A	CR0120009RT4	1	CR0120009RT6	1	CR0120009GT4	1	CR0120009GT6	R
	16A	CR0160009RT4	1	CR0160009RT6	1	CR0160009GT4	R	CR0160009GT6	1
	20A	CR0200009RT4	1	CR0200009RT6	1	CR0200009GT4	R	CR0200009GT6	1
	25A	CR0250009RT4	1	CR0250009RT6	1	CR0250009GT4	R	CR0250009GT6	1
	32A	CR0320009RT4	1	CR0320009RT6	1	CR0320009GT4	R	CR0320009GT6	R
	40A	CR0400009RT4	1	CR0400009RT6	1	CR0400009GT4	R	CR0400009GT6	R

standard article

R = on Request

### Rear mounting

2-screw fixing: 28mm (1.10") V. / 32mm (1.26") H.



**RT4**



**RT6**

### Rear mounting

Ø 22mm (0,87") single hole fixing



**GT4**



**GT6**

## STAR-DELTA Starter

Circuit diagram	Rated nom. current	Part no.	Pack	Part no.	Pack	Part no.	Pack	Part no.	Pack
			12A	CR0120010RT4	1	CR0120010RT6	1	CR0120010GT4	R
	16A	CR0160010RT4	1	CR0160010RT6	1	CR0160010GT4	R	CR0160010GT6	R
	20A	CR0200010RT4	1	CR0200010RT6	1	CR0200010GT4	R	CR0200010GT6	R
	25A	CR0250010RT4	1	CR0250010RT6	1	CR0250010GT4	R	CR0250010GT6	1
	32A	CR0320010RT4	1	CR0320010RT6	1	CR0320010GT4	R	CR0320010GT6	R
	40A	CR0400010RT4	1	CR0400010RT6	1	CR0320010GT4	R	CR0400010GT6	R

## Reversing switch pole changing

Circuit diagram	Rated nom. current	Part no.	Pack	Part no.	Pack	Part no.	Pack	Part no.	Pack
			12A	CR0120011RT4	1	CR0120011RT6	1	CR0120011GT4	R
	16A	CR0160011RT4	1	CR0160011RT6	1	CR0160011GT4	R	CR0160011GT6	R
	20A	CR0200011RT4	1	CR0200011RT6	1	CR0200011GT4	R	CR0200011GT6	R
	25A	CR0250011RT4	1	CR0250011RT6	1	CR0250011GT4	R	CR0250011GT6	R
	32A								
	40A								

## Switch single phase motor + aux phase

Circuit diagram	Rated nom. current	Part no.	Pack	Part no.	Pack	Part no.	Pack	Part no.	Pack
			12A	CR0120031RT4	1	CR0120031RT6	1	CR0120031GT4	R
	16A	CR0160031RT4	1	CR0160031RT6	1	CR0160031GT4	R	CR0160031GT6	R
	20A	CR0200031RT4	1	CR0200031RT6	1	CR0200031GT4	R	CR0200031GT6	R
	25A	CR0250031RT4	1	CR0250031RT6	1	CR0250031GT4	R	CR0250031GT6	R
	32A								
	40A								

standard article

R = on Request



**Rear mounting**  
2-screw fixing: 28mm (1.10") V. / 32mm (1.26") H.



**RT4**



**RT6**



**GT4**



**GT6**

**Rear mounting**  
Ø 22mm (0,87") single hole fixing

■ Reversing switch single-phase motor + aux phase

Circuit diagram	Rated nom. current	Part no.	Pack	Part no.	Pack	Part no.	Pack	Part no.	Pack
			12A	CR0120032RT4	1	CR0120032RT6	1	CR0120032GT4	R
16A	CR0160032RT4		1	CR0160032RT6	1	CR0160032GT4	R	CR0160032GT6	R
20A									
25A	CR0250032RT4		1	CR0250032RT6	1	CR0250032GT4	R	CR0250032GT6	R
32A									
40A									

■ Reversing switch single-phase motor + centrif.

Circuit diagram	Rated nom. current	Part no.	Pack	Part no.	Pack	Part no.	Pack	Part no.	Pack
			12A	CR0120034RT4	1	CR0120034RT6	1	CR0120034GT4	R
16A	CR0160034RT4		1	CR0160034RT6	1	CR0160034GT4	R	CR0160034GT6	R
20A	CR0200034RT4		1	CR0200034RT6	1	CR0200034GT4	R	CR0200034GT6	R
25A	CR0250034RT4		1	CR0250034RT6	1	CR0250034GT4	R	CR0250034GT6	R
32A									
40A									

■ Voltmeter switch 3 concatenated voltages

Circuit diagram	Rated nom. current	Part no.	Pack	Part no.	Pack	Part no.	Pack	Part no.	Pack
			12A	CR0120016RT4	1	CR0120016RT6	1	CR0120016GT4	1
16A									
20A									
25A									
32A									
40A									

standard article

R = on Request

**Rear mounting**  
2-screw fixing: 28mm (1.10") V. / 32mm (1.26") H.



**RT4**



**RT6**

**Rear mounting**  
Ø 22mm (0,87") single hole fixing



**GT4**



**GT6**

## ■ Voltmeter switch 3 concatenated voltages and 3 phase voltages

Circuit diagram	Rated nom. current	Part no.	Pack	Part no.	Pack	Part no.	Pack	Part no.	Pack
			12A	CR0120018RT4	1	CR0120018RT6	1	CR0120018GT4	R
	16A								
	20A								
	25A								
	32A								
	40A								

## ■ Ammeter switch 1 pole 3 current transformers

Circuit diagram	Rated nom. current	Part no.	Pack	Part no.	Pack	Part no.	Pack	Part no.	Pack
			12A	CR0120022RT4	1	CR0120022RT6	1	CR0120022GT4	R
	16A								
	20A								
	25A								
	32A								
	40A								

## ■ Multi step switch with off 1 pole 3 steps

Circuit diagram	Rated nom. current	Part no.	Pack	Part no.	Pack	Part no.	Pack	Part no.	Pack
			12A	CR012MZ13RT4	1	CR012MZ13RT6	1	CR012MZ13GT4	R
	16A	CR016MZ13RT4	1	CR016MZ13RT6	1	CR016MZ13GT4	R	CR016MZ13GT6	R
	20A	CR020MZ13RT4	1	CR020MZ13RT6	1	CR020MZ13GT4	R	CR020MZ13GT6	R
	25A	CR025MZ13RT4	1	CR025MZ13RT6	1	CR025MZ13GT4	R	CR025MZ13GT6	R
	32A								
	40A								

standard article

R = on Request

**Rear mounting**  
2-screw fixing: 28mm (1.10") V. / 32mm (1.26") H.



**RT4**



**RT6**

**Rear mounting**  
Ø 22mm (0,87") single hole fixing



**GT4**



**GT6**

### Multi step switch with off 1 pole 4 steps

Circuit diagram	Rated nom. current	Part no.	Pack	Part no.	Pack	Part no.	Pack	Part no.	Pack
			12A	CR012MZ14RT4	1	CR012MZ14RT6	1	CR012MZ14GT4	R
	16A	CR016MZ14RT4	1	CR016MZ14RT6	1	CR016MZ14GT4	R	CR016MZ14GT6	R
	20A								
	25A								
	32A								
	40A								

### Multi step switch with off 2 pole 3 steps

Circuit diagram	Rated nom. current	Part no.	Pack	Part no.	Pack	Part no.	Pack	Part no.	Pack
			12A	CR012MZ23RT4	1	CR012MZ23RT6	1	CR012MZ23GT4	R
	16A	CR016MZ23RT4	1	CR016MZ23RT6	1	CR016MZ23GT4	R	CR016MZ23GT6	R
	20A	CR020MZ23RT4	1	CR020MZ23RT6	1	CR020MZ23GT4	R	CR020MZ23GT6	R
	25A	CR025MZ23RT4	1	CR025MZ23RT6	1	CR025MZ23GT4	R	CR025MZ23GT6	R
	32A								
	40A								

### Multi step switch with off 2 pole 4 steps

Circuit diagram	Rated nom. current	Part no.	Pack	Part no.	Pack	Part no.	Pack	Part no.	Pack
			12A	CR012MZ24RT4	1	CR012MZ24RT6	1	CR012MZ24GT4	R
	16A	CR016MZ24RT4	1	CR016MZ24RT6	1	CR016MZ24GT4	R	CR016MZ24GT6	R
	20A								
	25A								
	32A								
	40A								

standard article

R = on Request

**Rear mounting**  
2-screw fixing: 28mm (1.10") V. / 32mm (1.26") H.



**RT4**



**RT6**

**Rear mounting**  
Ø 22mm (0,87") single hole fixing



**GT4**



**GT6**

## Multi step switch with off 3 pole 3 steps

 MZ33	Circuit diagram	Rated nom. current	Part no.	Pack	Part no.	Pack	Part no.	Pack	Part no.	Pack
				12A	CR012MZ33RT4	1	CR012MZ33RT6	1	CR012MZ33GT4	R
		16A	CR016MZ33RT4	1	CR016MZ33RT6	1	CR016MZ33GT4	R	CR016MZ33GT6	R
		20A								
		25A								
		32A								
		40A								

## Multi step switch without off 1 pole 3 steps

 M013	Circuit diagram	Rated nom. current	Part no.	Pack	Part no.	Pack	Part no.	Pack	Part no.	Pack
				12A	CR012M013RT4	1	CR012M013RT6	1	CR012M013GT4	R
		16A	CR016M013RT4	1	CR016M013RT6	1	CR016M013GT4	R	CR016M013GT6	R
		20A								
		25A								
		32A								
		40A								

**Rear mounting**

2-screw fixing: 28mm (1.10") V. / 32mm (1.26") H.



**RT4**



**RT6**

**Rear mounting**

Ø 22mm (0,87") single hole fixing



**GT4**



**GT6**

■ Multi step switch without off 1 pole 4 steps

Circuit diagram	Rated nom. current	Part no.	Pack	Part no.	Pack	Part no.	Pack	Part no.	Pack
			12A	CR012M014RT4	1	CR012M014RT6	1	CR012M014GT4	R
16A	CR016M014RT4		1	CR016M014RT6	1	CR016M014GT4	R	CR016M014GT6	R
20A									
25A									
32A									
40A									

■ Multi step switch without off 1 pole 5 steps

Circuit diagram	Rated nom. current	Part no.	Pack	Part no.	Pack	Part no.	Pack	Part no.	Pack
			12A	CR012M015RT4	1	CR012M015RT6	1	CR012M015GT4	R
16A	CR016M015RT4		1	CR016M015RT6	1	CR016M015GT4	R	CR016M015GT6	R
20A									
25A									
32A									
40A									

standard article

R = on Request

### Rear mounting

2-screw fixing: 28mm (1.10") V. / 32mm (1.26") H.



**RL6**



**RK6**

### Base mounting\*

2-screw fixing: 28mm (1.10") V. / 32mm (1.26") H.



**BL6**



**BK6**

## ON-OFF switch 3 pole with padlockable handle

 00G3	Circuit diagram	Rated nom. current	Part no.	Pack	Part no.	Pack	Part no.	Pack	Part no.	Pack
			12A	CR01200G3RL6	1	CR01200G3RK6	1	CR01200G3BL6	1	CR01200G3BK6
		16A	CR01600G3RL6	1	CR01600G3RK6	1	CR01600G3BL6	1	CR01600G3BK6	1
		20A	CR02000G3RL6	1	CR02000G3RK6	1	CR02000G3BL6	1	CR02000G3BK6	1
		25A	CR02500G3RL6	1	CR02500G3RK6	1	CR02500G3BL6	1	CR02500G3BK6	1
		32A	CR03200G3RL6	1	CR03200G3RK6	1	CR03200G3BL6	1	CR03200G3BK6	1
		40A	CR04000G3RL6	1	CR04000G3RK6	1	CR04000G3BL6	1	CR04000G3BK6	1

## ON-OFF switch 4 pole with padlockable handle

 00G4	Circuit diagram	Rated nom. current	Part no.	Pack	Part no.	Pack	Part no.	Pack	Part no.	Pack
			12A	CR01200G4RL6	1	CR01200G4RK6	1	CR01200G4BL6	1	CR01200G4BK6
		16A	CR01600G4RL6	1	CR01600G4RK6	1	CR01600G4BL6	1	CR01600G4BK6	1
		20A	CR02000G4RL6	1	CR02000G4RK6	1	CR02000G4BL6	1	CR02000G4BK6	1
		25A	CR02500G4RL6	1	CR02500G4RK6	1	CR02500G4BL6	1	CR02500G4BK6	1
		32A	CR03200G4RL6	1	CR03200G4RK6	1	CR03200G4BL6	1	CR03200G4BK6	1
		40A	CR04000G4RL6	1	CR04000G4RK6	1	CR04000G4BL6	1	CR04000G4BK6	1

\* Base mounting switches are supplied with standard 175mm (6.89") shaft

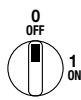
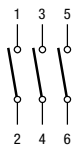

### ■ ON-OFF switch 3 pole with padlockable handle

 00G3	Circuit diagram	Rated nom. current	Part no.	Pack	Part no.	Pack	Part no.	Pack	Part no.	Pack
			12A	CR01200G3GL6	R	CR01200G3GK6	R	CR01200G3HL6	R	CR01200G3HK6
	16A	CR01600G3GL6	1	CR01600G3GK6	R	CR01600G3HL6	1	CR01600G3HK6	R	
	20A	CR02000G3GL6	R	CR02000G3GK6	R	CR02000G3HL6	R	CR02000G3HK6	R	
	25A	CR02500G3GL6	1	CR02500G3GK6	R	CR02500G3HL6	1	CR02500G3HK6	R	
	32A	CR03200G3GL6	R	CR03200G3GK6	R	CR03200G3HL6	1	CR03200G3HK6	R	
	40A	CR04000G3GL6	R	CR04000G3GK6	R	CR04000G3HL6	R	CR04000G3HK6	R	

### ■ ON-OFF switch 4 pole with padlockable handle

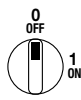
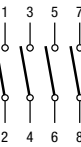
 00G4	Circuit diagram	Rated nom. current	Part no.	Pack	Part no.	Pack	Part no.	Pack	Part no.	Pack
			12A	CR01200G4GL6	R	CR01200G4GK6	R	CR01200G4HL6	R	CR01200G4HK6
	16A	CR01600G4GL6	1	CR01600G4GK6	R	CR01600G4HL6	1	CR01600G4HK6	R	
	20A	CR02000G4GL6	R	CR02000G4GK6	R	CR02000G4HL6	R	CR02000G4HK6	R	
	25A	CR02500G4GL6	1	CR02500G4GK6	R	CR02500G4HL6	1	CR02500G4HK6	R	
	32A	CR03200G4GL6	R	CR03200G4GK6	R	CR03200G4HL6	1	CR03200G4HK6	R	
	40A	CR04000G4GL6	R	CR04000G4GK6	R	CR04000G4HL6	R	CR04000G4HK6	R	

\* Base mounting switches are supplied with standard 175mm (6.89'') shaft

 standard article

R = on Request

**Rear mounting**  
4-screw fixing: □ 36mm (□1.42") / □ 48mm (□1.89")



**RV4**



**RV6**

**Rear mounting**  
Ø 22mm (0,87") single hole fixing



**GV4**



**GV6**

## ■ ON-OFF switch 1 pole

Circuit diagram	Rated nom. current	Part no.	Pack	Part no.	Pack	Part no.	Pack	Part no.	Pack
			12A	CR0120001RV4	R			CR0120001GV4	R
	16A	CR0160001RV4	R			CR0160001GV4	R		
	20A	CR0200001RV4	R			CR0200001GV4	R		
	25A			CR0250001RV6	R			CR0250001GV6	R
	32A								
	40A								

## ■ ON-OFF switch 2 pole

Circuit diagram	Rated nom. current	Part no.	Pack	Part no.	Pack	Part no.	Pack	Part no.	Pack
			12A	CR0120002RV4	1			CR0120002GV4	R
	16A	CR0160002RV4	1			CR0160002GV4	R		
	20A	CR0200002RV4	R			CR0200002GV4	R		
	25A			CR0250002RV6	R			CR0250002GV6	R
	32A			CR0320002RV6	R			CR0320002GV6	R
	40A			CR0400002RV6	R			CR0400002GV6	R

## ■ ON-OFF switch 3 pole

Circuit diagram	Rated nom. current	Part no.	Pack	Part no.	Pack	Part no.	Pack	Part no.	Pack
			12A	CR0120003RV4	1			CR0120003GV4	R
	16A	CR0160003RV4	1			CR0160003GV4	R		
	20A	CR0200003RV4	1			CR0200003GV4	R		
	25A			CR0250003RV6	1			CR0250003GV6	R
	32A			CR0320003RV6	1			CR0320003GV6	R
	40A			CR0400003RV6	R			CR0400003GV6	R

standard article

R = on Request



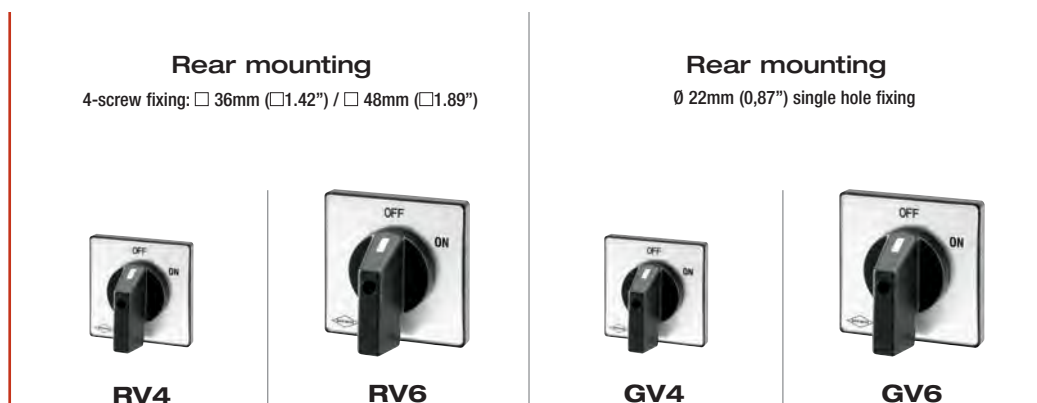

### ■ ON-OFF switch 4 pole

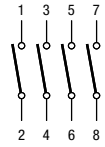
Circuit diagram	Rated nom. current	Part no.	Pack	Part no.	Pack	Part no.	Pack	Part no.	Pack
			12A	CR0120004RV4	R			CR0120004GV4	R
	16A	CR0160004RV4	R			CR0160004GV4	R		
	20A	CR0200004RV4	R			CR0200004GV4	R		
	25A			CR0250004RV6	R			CR0250004GV6	R
	32A			CR0320004RV6	R			CR0320004GV6	R
	40A			CR0400004RV6	R			CR0400004GV6	R

### ■ ON-OFF switch 3 pole with spring return to "OFF"

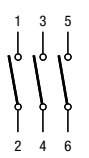
Circuit diagram	Rated nom. current	Part no.	Pack	Part no.	Pack	Part no.	Pack	Part no.	Pack
			12A	CR0120035RV4	R			CR0120035GV4	R
	16A	CR0160035RV4	R			CR0160035GV4	R		
	20A								
	25A								
	32A								
	40A								

### ■ Change-over switch 1 pole

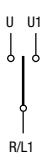
Circuit diagram	Rated nom. current	Part no.	Pack	Part no.	Pack	Part no.	Pack	Part no.	Pack
			12A	CR0120005RV4	R			CR0120005GV4	R
	16A	CR0160005RV4	R			CR0160005GV4	R		
	20A	CR0200005RV4	R			CR0200005GV4	R		
	25A			CR0250005RV6	R			CR0250005GV6	R
	32A								
	40A								

 standard article

R = on Request

**Rear mounting**  
4-screw fixing: □ 36mm (□1.42") / □ 48mm (□1.89")



**RV4**



**RV6**

**Rear mounting**  
Ø 22mm (0.87") single hole fixing



**GV4**



**GV6**

## Change-over switch 2 pole

 0006	Circuit diagram	Rated nom. current	Part no.	Pack	Part no.	Pack	Part no.	Pack	Part no.	Pack
			12A	CR0120006RV4	R			CR0120006GV4	R	
		16A	CR0160006RV4	R			CR0160006GV4	R		
		20A	CR0200006RV4	R			CR0200006GV4	R		
		25A			CR0250006RV6	R			CR0250006GV6	R
		32A			CR0320006RV6	R			CR0320006GV6	R
		40A			CR0400006RV6	R			CR0400006GV6	R

## Change-over switch 3 pole

 0007	Circuit diagram	Rated nom. current	Part no.	Pack	Part no.	Pack	Part no.	Pack	Part no.	Pack
			12A	CR0120007RV4	R			CR0120007GV4	R	
		16A	CR0160007RV4	1			CR0160007GV4	R		
		20A	CR0200007RV4	R			CR0200007GV4	R		
		25A			CR0250007RV6	1			CR0250007GV6	R
		32A			CR0320007RV6	R			CR0320007GV6	R
		40A			CR0400007RV6	R			CR0400007GV6	R

## Change-over switch 4 pole

 0039	Circuit diagram	Rated nom. current	Part no.	Pack	Part no.	Pack	Part no.	Pack	Part no.	Pack
			12A	CR0120039RV4	R			CR0120039GV4	R	
		16A	CR0160039RV4	1			CR0160039GV4	R		
		20A	CR0200039RV4	R			CR0200039GV4	R		
		25A			CR0250039RV6	1			CR0250039GV6	R
		32A			CR0320039RV6	R			CR0320039GV6	R
		40A			CR0400039RV6	R			CR0400039GV6	R

standard article

R = on Request

**Rear mounting**  
4-screw fixing: □ 36mm (□1.42") / □ 48mm (□1.89")



**RV4**



**RV6**



**GV4**



**GV6**

**Rear mounting**  
Ø 22mm (0,87") single hole fixing

■ Reversing switch 3 pole

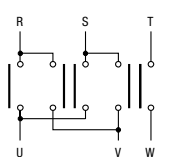
Circuit diagram	Rated nom. current	Part no.	Pack	Part no.	Pack	Part no.	Pack	Part no.	Pack
			12A	CR0120008RV4	1			CR0120008GV4	R
	16A	CR0160008RV4	1			CR0160008GV4	R		
	20A	CR0200008RV4	1			CR0200008GV4	R		
	25A			CR0250008RV6	1			CR0250008GV6	R
	32A			CR0320008RV6	1			CR0320008GV6	R
	40A			CR0400008RV6	R			CR0320008GV6	R

■ Reversing switch 3 pole with spring return to "off"

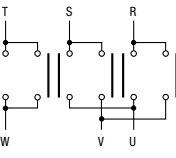
Circuit diagram	Rated nom. current	Part no.	Pack	Part no.	Pack	Part no.	Pack	Part no.	Pack
			12A	CR0120036RV4	R			CR0120036GV4	R
	16A	CR0160036RV4	R			CR0160036GV4	R		
	20A	CR0200036RV4	R			CR0200036GV4	R		
	25A			CR0250036RV6	R			CR0250036GV6	R
	32A								
	40A								

■ Changing switch Dahlander pole

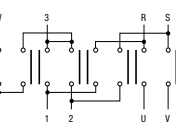
Circuit diagram	Rated nom. current	Part no.	Pack	Part no.	Pack	Part no.	Pack	Part no.	Pack
			12A	CR0120009RV4	1			CR0120009GV4	R
	16A	CR0160009RV4	1			CR0160009GV4	R		
	20A	CR0200009RV4	R			CR0200009GV4	R		
	25A			CR0250009RV6	R			CR0250009GV6	R
	32A			CR0320009RV6	R			CR0320009GV6	R
	40A			CR0400009RV6	R			CR0400009GV6	R

□ standard article

R = on Request

### Rear mounting

4-screw fixing: □ 36mm (□1.42") / □ 48mm (□1.89")



**RV4**



**RV6**

### Rear mounting

∅ 22mm (0,87") single hole fixing



**GV4**



**GV6**

## STAR-DELTA Starter

Circuit diagram	Rated nom. current	Part no.	Pack	Part no.	Pack	Part no.	Pack	Part no.	Pack
			12A	CR0120010RV4	R			CR0120010GV4	R
	16A	CR0160010RV4	1			CR0160010GV4	R		
	20A	CR0200010RV4	R			CR0200010GV4	R		
	25A			CR0250010RV6	1			CR0250010GV6	R
	32A			CR0320010RV6	R			CR0320010GV6	R
	40A			CR0400010RV6	R			CR0400010GV6	R

## Reversing switch pole changing

Circuit diagram	Rated nom. current	Part no.	Pack	Part no.	Pack	Part no.	Pack	Part no.	Pack
			12A	CR0120011RV4	R			CR0120011GV4	R
	16A	CR0160011RV4	R			CR0160011GV4	R		
	20A	CR0200011RV4	R			CR0200011GV4	R		
	25A			CR0250011RV6	R			CR0250011GV6	R
	32A								
	40A								

## Switch single phase motor + aux phase

Circuit diagram	Rated nom. current	Part no.	Pack	Part no.	Pack	Part no.	Pack	Part no.	Pack
			12A	CR0120031RV4	R			CR0120031GV4	R
	16A	CR0160031RV4	R			CR0160031GV4	R		
	20A	CR0200031RV4	R			CR0200031GV4	R		
	25A			CR0250031RV6	R			CR0250031GV6	R
	32A								
	40A								

□ standard article

R = on Request

**Rear mounting**  
4-screw fixing: □ 36mm (□1.42") / □ 48mm (□1.89")



**RV4**



**RV6**



**GV4**



**GV6**

**Rear mounting**  
Ø 22mm (0,87") single hole fixing

■ Reversing switch single-phase motor + aux phase

Circuit diagram	Rated nom. current	Part no.	Pack	Part no.	Pack	Part no.	Pack	Part no.	Pack
			12A	CR0120032RV4	R			CR0120032GV4	R
16A	CR0160032RV4		R			CR0160032GV4	R		
20A									
25A				CR0250032RV6	R			CR0250032GV6	R
32A									
40A									

■ Reversing switch single-phase motor + centrif.

Circuit diagram	Rated nom. current	Part no.	Pack	Part no.	Pack	Part no.	Pack	Part no.	Pack
			12A	CR0120034RV4	R			CR0120034GV4	R
16A	CR0160034RV4		R			CR0160034GV4	R		
20A	CR0200034RV4		R			CR0200034GV4	R		
25A				CR0250034RV6	R			CR0250034GV6	R
32A									
40A									

■ Voltmeter switch 3 concatenated voltages

Circuit diagram	Rated nom. current	Part no.	Pack	Part no.	Pack	Part no.	Pack	Part no.	Pack
			12A	CR0120016RV4	1			CR0120016GV4	R
16A									
20A									
25A									
32A									
40A									

standard article

R = on Request

### Rear mounting

4-screw fixing: □ 36mm (□1.42") / □ 48mm (□1.89")



**RV4**



**RV6**



**GV4**



**GV6**

### Rear mounting

∅ 22mm (0.87") single hole fixing

## ■ Voltmeter switch 3 concatenated voltages and 3 phase voltages

Circuit diagram	Rated nom. current	Part no.	Pack	Part no.	Pack	Part no.	Pack	Part no.	Pack
			12A	CR0120018RV4	R			CR0120018GV4	R
	16A								
	20A								
	25A								
	32A								
	40A								

## ■ Ammeter switch 1 pole 3 current transformers

Circuit diagram	Rated nom. current	Part no.	Pack	Part no.	Pack	Part no.	Pack	Part no.	Pack
			12A	CR0120022RV4	1			CR0120022GV4	R
	16A								
	20A								
	25A								
	32A								
	40A								

## ■ Multi step switch with off 1 pole 3 steps

Circuit diagram	Rated nom. current	Part no.	Pack	Part no.	Pack	Part no.	Pack	Part no.	Pack
			12A	CR012MZ13RV4	R			CR012MZ13GV4	R
	16A	CR016MZ13RV4	R			CR016MZ13GV4	R		
	20A	CR020MZ13RV4	R			CR020MZ13GV4	R		
	25A			CR025MZ13RV6	R			CR025MZ13GV6	R
	32A								
	40A								

□ standard article

R = on Request

**Rear mounting**  
4-screw fixing: □ 36mm (□1.42") / □ 48mm (□1.89")



**RV4**



**RV6**

**Rear mounting**  
Ø 22mm (0,87") single hole fixing



**GV4**



**GV6**

■ Multi step switch with off 1 pole 4 steps

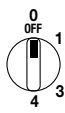
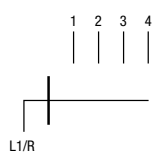
 <b>MZ14</b>	Circuit diagram	Rated nom. current	Part no.	Pack	Part no.	Pack	Part no.	Pack	Part no.	Pack
		12A	CR012MZ14RV4	R			CR012MZ14GV4	R		
	16A	CR016MZ14RV4	R			CR016MZ14GV4	R			
	20A									
	25A									
	32A									
	40A									

■ Multi step switch with off 2 pole 3 steps

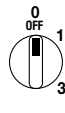
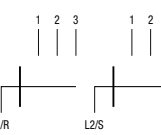
 <b>MZ23</b>	Circuit diagram	Rated nom. current	Part no.	Pack	Part no.	Pack	Part no.	Pack	Part no.	Pack
		12A	CR012MZ23RV4	R			CR012MZ23GV4	R		
	16A	CR016MZ23RV4	R			CR016MZ23GV4	R			
	20A	CR020MZ23RV4	R			CR020MZ23GV4	R			
	25A				CR025MZ23RV6	R			CR025MZ23GV6	R
	32A									
	40A									

■ Multi step switch with off 2 pole 4 steps

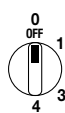
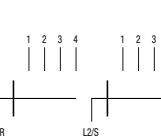
 <b>MZ24</b>	Circuit diagram	Rated nom. current	Part no.	Pack	Part no.	Pack	Part no.	Pack	Part no.	Pack
		12A	CR012MZ24RV4	R			CR012MZ24GV4	R		
	16A	CR016MZ24RV4	R			CR016MZ24GV4	R			
	20A									
	25A									
	32A									
	40A									

□ standard article

R = on Request

### Rear mounting

4-screw fixing: □ 36mm (□1.42") / □ 48mm (□1.89")



**RV4**



**RV6**

### Rear mounting

∅ 22mm (0,87") single hole fixing



**GV4**



**GV6**

## ■ Multi step switch with off 3 pole 3 steps

Circuit diagram	Rated nom. current	Part no.	Pack	Part no.	Pack	Part no.	Pack	Part no.	Pack
			12A	CR012MZ33RV4	R			CR012MZ33GV4	R
	16A	CR016MZ33RV4	R			CR016MZ33GV4	R		
	20A								
	25A								
	32A								
	40A								

## ■ Multi step switch without off 1 pole 3 steps

Circuit diagram	Rated nom. current	Part no.	Pack	Part no.	Pack	Part no.	Pack	Part no.	Pack
			12A	CR012M013RV4	R			CR012M013GV4	R
	16A	CR016M013RV4	R			CR016M013GV4	R		
	20A								
	25A								
	32A								
	40A								



**Rear mounting**

4-screw fixing: □ 36mm (□1.42") / □ 48mm (□1.89")



**RV4**



**RV6**

**Rear mounting**

∅ 22mm (0,87") single hole fixing



**GV4**



**GV6**

■ Multi step switch without off 1 pole 4 steps

Circuit diagram	Rated nom. current	Part no.	Pack	Part no.	Pack	Part no.	Pack	Part no.	Pack
		<p><b>M014</b></p>	12A	CR012M014RV4	R			CR012M014GV4	R
16A	CR016M014RV4		R			CR016M014GV4	R		
20A									
25A									
32A									
40A									

■ Multi step switch without off 1 pole 5 steps

Circuit diagram	Rated nom. current	Part no.	Pack	Part no.	Pack	Part no.	Pack	Part no.	Pack
		<p><b>M015</b></p>	12A	CR012M015RV4	R			CR012M015GV4	R
16A	CR016M015RV4		R			CR016M015GV4	R		
20A									
25A									
32A									
40A									

□ standard article

R = on Request

### Rear mounting

4-screw fixing: □ 36mm (□1.42") / □ 48mm (□1.89")



**RL5**



**RK5**

### Base mounting

4-screw fixing: □ 36mm (□1.42") / □ 48mm (□1.89")



**BL5**



**BK5**

## ■ ON-OFF switch 3 pole with padlockable handle

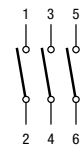
 <b>00G3</b>	Circuit diagram	Rated nom. current	Part no.	Pack	Part no.	Pack	Part no.	Pack	Part no.	Pack
			12A	CR01200G3RL5	1	CR01200G3RK5	R	CR01200G3BL5	R	CR01200G3BK5
		16A	CR01600G3RL5	1	CR01600G3RK5	R	CR01600G3BL5	1	CR01600G3BK5	R
		20A	CR02000G3RL5	R	CR02000G3RK5	R	CR02000G3BL5	R	CR02000G3BK5	R
		25A	CR02500G3RL5	R	CR02500G3RK5	R	CR02500G3BL5	1	CR02500G3BK5	R
		32A	CR03200G3RL5	R	CR03200G3RK5	R	CR03200G3BL5	R	CR03200G3BK5	R
		40A	CR04000G3RL5	R	CR04000G3RK5	R	CR04000G3BL5	R	CR04000G3BK5	R

## ■ ON-OFF switch 4 pole with padlockable handle

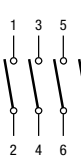
 <b>00G4</b>	Circuit diagram	Rated nom. current	Part no.	Pack	Part no.	Pack	Part no.	Pack	Part no.	Pack
			12A	CR01200G4RL5	R	CR01200G4RK5	R	CR01200G4BL5	R	CR01200G4BK5
		16A	CR01600G4RL5	R	CR01600G4RK5	R	CR01600G4BL5	1	CR01600G4BK5	R
		20A	CR02000G4RL5	R	CR02000G4RK5	R	CR02000G4BL5	R	CR02000G4BK5	R
		25A	CR02500G4RL5	R	CR02500G4RK5	R	CR02500G4BL5	1	CR02500G4BK5	R
		32A	CR03200G4RL5	R	CR03200G4RK5	R	CR03200G4BL5	1	CR03200G4BK5	R
		40A	CR04000G4RL5	R	CR04000G4RK5	R	CR04000G4BL5	R	CR04000G4BK5	R

\* Base mounting switches are supplied with standard 175mm (6.89") shaft

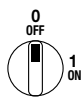
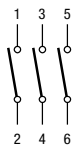

### ■ ON-OFF switch 3 pole with padlockable handle

 <b>00G3</b>	Circuit diagram	Rated nom. current	Part no.	Pack	Part no.	Pack	Part no.	Pack	Part no.	Pack
			12A	CR01200G3GL5	R	CR01200G3GK5	R	CR01200G3HL5	R	CR01200G3HK5
		16A	CR01600G3GL5	R	CR01600G3GK5	R	CR01600G3HL5	R	CR01600G3HK5	R
		20A	CR02000G3GL5	R	CR02000G3GK5	R	CR02000G3HL5	R	CR02000G3HK5	R
		25A	CR02500G3GL5	R	CR02500G3GK5	R	CR02500G3HL5	R	CR02500G3HK5	R
		32A	CR03200G3GL5	R	CR03200G3GK5	R	CR03200G3HL5	R	CR03200G3HK5	R
		40A	CR04000G3GL5	R	CR04000G3GK5	R	CR04000G3HL5	R	CR04000G3HK5	R

### ■ ON-OFF switch 4 pole with padlockable handle

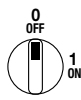
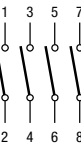





 <b>00G4</b>	Circuit diagram	Rated nom. current	Part no.	Pack	Part no.	Pack	Part no.	Pack	Part no.	Pack
			12A	CR01200G4GL5	R	CR01200G4GK5	R	CR01200G4HL5	R	CR01200G4HK5
		16A	CR01600G4GL5	R	CR01600G4GK5	R	CR01600G4HL5	R	CR01600G4HK5	R
		20A	CR02000G4GL5	R	CR02000G4GK5	R	CR02000G4HL5	R	CR02000G4HK5	R
		25A	CR02500G4GL5	R	CR02500G4GK5	R	CR02500G4HL5	R	CR02500G4HK5	R
		32A	CR03200G4GL5	R	CR03200G4GK5	R	CR03200G4HL5	R	CR03200G4HK5	R
		40A	CR04000G4GL5	R	CR04000G4GK5	R	CR04000G4HL5	R	CR04000G4HK5	R

\* Base mounting switches are supplied with standard 175mm (6.89") shaft

 standard article







R = on Request

## Plates and knobs

	Description	Handle fixing option	Switch fixing option				Legend included	
			Rear mount	Pack	Base mount	Pack	Legend type	Degrees
	grey plate 67x67mm (2.64x2.64"), black padlockable knob (max 3 padlocks), IP66	with 2 screws	<b>FINRK6Q5</b>	5	<b>FINBK6Q5</b>	5	0 - 1	90°
		with Ø22mm (0,87") single-hole	<b>FINGK6Q5</b>	R	<b>FINHK6Q5</b>	R	0 - 1	90°
	grey plate 67x67mm (2.64x2.64"), black padlockable knob (max 3 padlocks), IP66	with 2 screws	<b>FINRL6Q5</b>	5	<b>FINBL6Q5</b>	5	0 - 1	90°
		with Ø22mm (0,87") single-hole	<b>FINGL6Q5</b>	5	<b>FINHL6Q5</b>	5	0 - 1	90°
	grey plate 67x67mm (2.64x2.64"), black knob, IP66	with 2 screws	<b>FINRT6Q5</b>	5	<b>FINBT6Q5</b>	R	0 - 1 1 - 0 - 2	60°
		with Ø22mm (0,87") single-hole	<b>FINGT6Q5</b>	5	<b>FINHT6Q5</b>	R	0 - 1 1 - 0 - 2	60°
	yellow plate 67x67mm (2.64x2.64"), red knob, IP66	with 2 screws	<b>FINRY6Q5</b>	R	<b>FINBY6Q5</b>	R	0 - 1 1 - 0 - 2	60°
		with Ø22mm (0,87") single-hole	<b>FINGY6Q5</b>	R	<b>FINHY6Q5</b>	R	0 - 1 1 - 0 - 2	60°
	grey plate 48x48mm (1.89x1.89"), black knob, IP66	with 2 screws	<b>FINRT4Q5</b>	5	<b>FINBT4Q5</b>	R	0 - 1 1 - 0 - 2	60°
		with Ø22mm (0,87") single-hole	<b>FINGT4Q5</b>	5	<b>FINHT4Q5</b>	R	0 - 1 1 - 0 - 2	60°
	yellow plate 48x48mm (1.89x1.89"), red knob, IP66	with 2 screws	<b>FINRY4Q5</b>	R	<b>FINBY4Q5</b>	R	0 - 1 1 - 0 - 2	60°
		with Ø22mm (0,87") single-hole	<b>FINGY4Q5</b>	R	<b>FINHY4Q5</b>	R	0 - 1 1 - 0 - 2	60°

Two-screw fixing, distance between holes: 28mm (1.10") Vertical or 32mm (1.26") Horizontal

## Plates and knobs

	Description	Handle fixing option	Switch fixing option				Legend included	
			Rear mount	Pack	Base mount	Pack	Legend type	Degrees
	grey plate 67x67mm (2.64x2.64"), black padlockable knob (max 3 padlocks), IP66	with 4 screws	<b>FINRK5Q5</b>	R	<b>FINBK5Q5</b>	R	0 - 1	90°
		with Ø22mm (0,87") single-hole	<b>FINGK5Q5</b>	R	<b>FINHK5Q5</b>	R	0 - 1	90°
	yellow plate 67x67mm (2.64x2.64"), red padlockable knob (max 3 padlocks), IP66	with 4 screws	<b>FINRL5Q5</b>	5	<b>FINBL5Q5</b>	5	0 - 1	90°
		with Ø22mm (0,87") single-hole	<b>FINGL5Q5</b>	R	<b>FINHL5Q5</b>	R	0 - 1	90°
	grey plate 64x64mm (2.52x2.52"), black knob, IP66	with 4 screws	<b>FINRV6Q5</b>	5	<b>FINBV6Q5</b>	R	0 - 1 1 - 0 - 2	60°
		with Ø22mm (0,87") single-hole	<b>FINGV6Q5</b>	R	<b>FINHV6Q5</b>	R	0 - 1 1 - 0 - 2	60°
	yellow plate 64x64mm (2.52x2.52"), red knob, IP66	with 4 screws	<b>FINRW6Q5</b>	R	<b>FINBW6Q5</b>	R	0 - 1 1 - 0 - 2	60°
		with Ø22mm (0,87") single-hole	<b>FINGW6Q5</b>	R	<b>FINHW6Q5</b>	R	0 - 1 1 - 0 - 2	60°
	grey plate 48x48mm (1.89x1.89"), black knob, IP66	with 4 screws	<b>FINRV4Q5</b>	5	<b>FINBV4Q5</b>	R	0 - 1 1 - 0 - 2	60°
		with Ø22mm (0,87") single-hole	<b>FINGV4Q5</b>	R	<b>FINHV4Q5</b>	R	0 - 1 1 - 0 - 2	60°
	yellow plate 48x48mm (1.89x1.89"), red knob, IP66	with 4 screws	<b>FINRW4Q5</b>	R	<b>FINBW4Q5</b>	R	0 - 1 1 - 0 - 2	60°
		with Ø22mm (0,87") single-hole	<b>FINGW4Q5</b>	R	<b>FINHW4Q5</b>	R	0 - 1 1 - 0 - 2	60°



Two-screw fixing, distance between holes: 28mm (1.10") Vertical or 32mm (1.26") Horizontal

Four-screw fixing, distance between holes: 48x48mm (1.89"x1.89") or 36x36mm (1.42"x1.42")

 standard article

R = on Request

## Plates and knobs

	Description	Handle fixing option	Switch fixing option				Legend included	
			Rear mount	Pack	Base mount	Pack	Legend type	Degrees
	grey plate 64x78mm (2.52"x3.07"), black knob, IP66	with 4 screws	FINRV6-TQ5	R	FINBV6-TQ5	R	0 - 1 1 - 0 - 2	60°
		with Ø22mm (0,87") single-hole	FINGV6-TQ5	R	FINHV6-TQ5	R	0 - 1 1 - 0 - 2	60°
	grey plate 48x59mm (1.89"x2.32"), black knob, IP66	with 4 screws	FINRV4-TQ5	R	FINBV4-TQ5	R	0 - 1 1 - 0 - 2	60°
		with Ø22mm (0,87") single-hole	FINGV4-TQ5	R	FINHV4-TQ5	R	0 - 1 1 - 0 - 2	60°

## Optional shafts

	Part no.	Description	Pack
	PALBL300	Shaft L=300mm Q5	5
	PALBL500	Shaft L=500mm Q5	5
	PALBL065	Shaft L=65mm Q5	R
	PALBL075	Shaft L=75mm Q5	R
	PALBL095	Shaft L=95mm Q5	R
	PALBL115	Shaft L=115mm Q5	R
	PALBL135	Shaft L=135mm Q5	R
	PALBL155	Shaft L=155mm Q5	R
	PALBL175	Shaft L=175mm Q5	5

## Flexible PVC protections IP40

IP40 PVC protections against dust and dirt are available on request.



 standard article

R = on Request

■ Rear mounting

(RT - RY - RL6 - RK6 - RR0) - Measures in mm (in)

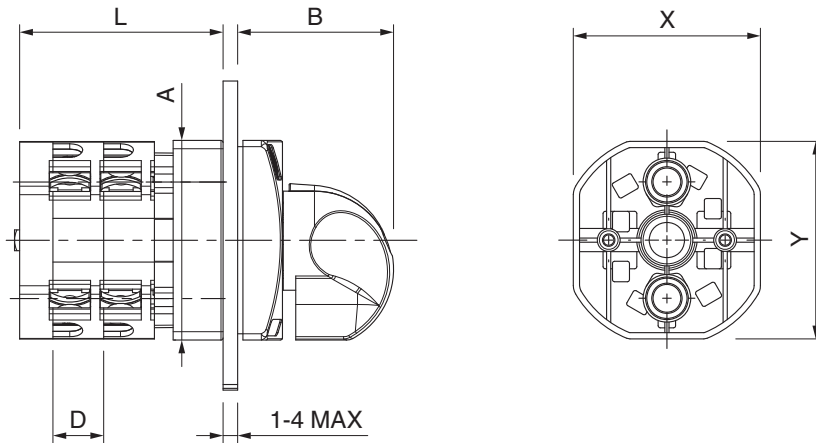

Series	X	Y	A	D		no. of stages					
						1	2	3	4	5	6
CR 012-016-020	45	47,5	□ 48	12,2	L	36,7	49	61,1	73,3	85,5	97,7
	(1.77")	(1.87")	(□1.89")	(0.48")		(1.44")	(1.93")	(2.41")	(2.89")	(3.37")	(3.85")
CR 025-032-040	53	62	□ 60	16,2	L	42,8	59	75	91,5	108	124
	(2.09")	(2.44")	(□2.36")	(0.64")		(1.69")	(2.32")	(2.95")	(3.60")	(4.25")	(4.88")

Handle	B
RT4	37 (1.46")
RT6	39 (1.54")
RL6-RK6	39 (1.54")
RR0	34 (1.34")

■ Rear mounting

(GT - GY - GL6 - GK6 - GR0) - Measures in mm (in)

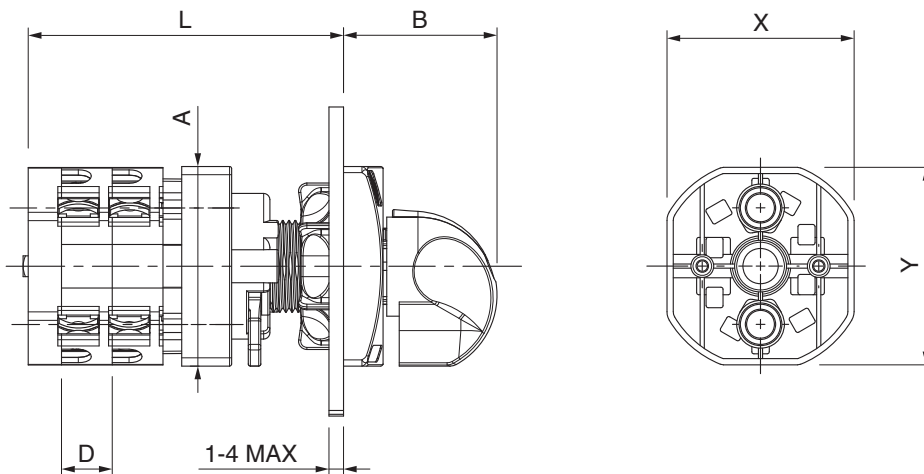

Series	X	Y	A	D		no. of stages					
						1	2	3	4	5	6
CR 012-016-020	45	47,5	□ 48	12,2	L	63,5	76	88,2	100,5	112,6	124,8
	(1.77")	(1.87")	(□1.89")	(0.48")		(2.50")	(2.99")	(3.47")	(3.96")	(4.43")	(4.91")
CR 025-032-040	53	62	□ 60	16,2	L	69,8	86	102	118,5	135	151
	(2.09")	(2.44")	(□2.36")	(0.64")		(2.75")	(3.39")	(4.02")	(4.67")	(5.31")	(5.94")

Handle	B
GT4	37 (1.46")
GT6	39 (1.54")
GL6-GK6	39 (1.54")
GR0	38 (1.50")

## ■ Base mounting

Switching angle 90°, padlockable (max 3 padlocks)

(BT - BY - BL6 - BK6) - Measures in mm (in)

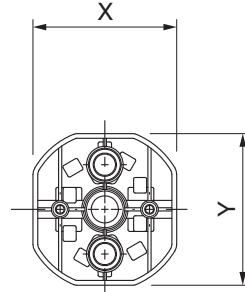
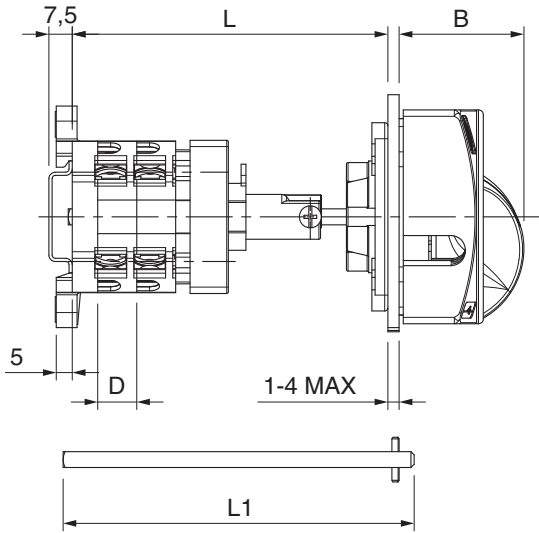

Handle	B
BL6-BK6	39 (1.54")
BT4L-BY4L	40 (1.57")
BT6L-BY6L	40 (1.57")

	no. of stages				2	
	X	Y	D	L1	L	
					Lmin	Lmax
CR 012-016-020	45	47,5	12,2	175 (6.89") *	99 (3.90")	243 (9.57")
	(1.77")	(1.87")	(0.48")	300 (11.81")	99 (3.90")	368 (14.49")
				500 (19.69")	99 (3.90")	568 (22.36")
CR 025-032-040	53	62	16,2	175 (6.89") *	109 (4.29")	253 (9.96")
	(2.09")	(2.44")	(0.64")	300 (11.81")	109 (4.29")	378 (14.88")
				500 (19.69")	109 (4.29")	578 (22.76")

Overall length (min-max)\*\* for different shaft lengths (L1)

\* Standard shaft, bundled

\*\* Minimum length is obtainable by cutting the shaft

## ■ Rear mounting

Switching angle 90°, padlockable (max 3 padlocks)

(HT - HY - HL6 - HK6) - Measures in mm (in)

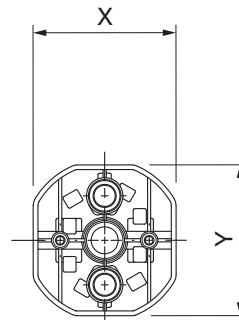
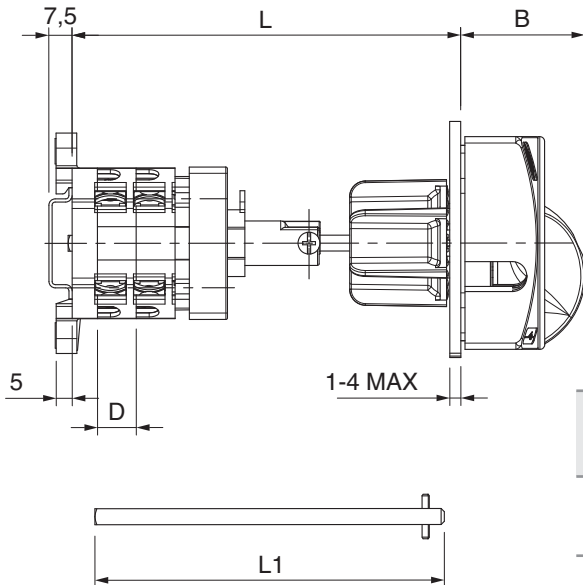

Handle	B
HL6-HK6	39 (1.54")
GT4L-GY4L	40 (1.57")
GT6L-GY6L	40 (1.57")

	no. of stages				2	
	X	Y	D	L1	L	
					Lmin	Lmax
CR 012-016-020	45	47,5	12,2	175 (6.89") *	111 (4.37")	255 (10.04")
	(1.77")	(1.87")	(0.48")	300 (11.81")	111 (4.37")	380 (14.96")
				500 (19.69")	111 (4.37")	580 (22.83")
CR 025-032-040	53	62	16,2	175 (6.89") *	121 (4.76")	265 (10.43")
	(2.09")	(2.44")	(0.64")	300 (11.81")	121 (4.76")	390 (15.35")
				500 (19.69")	121 (4.76")	590 (23.23")

Overall length (min-max)\*\* for different shaft lengths (L1)

\* Standard shaft, bundled

\*\* Minimum length is obtainable by cutting the shaft



■ Rear mounting

(RT - RY - RL6 - RK6 - RR0) - Measures in mm (in)

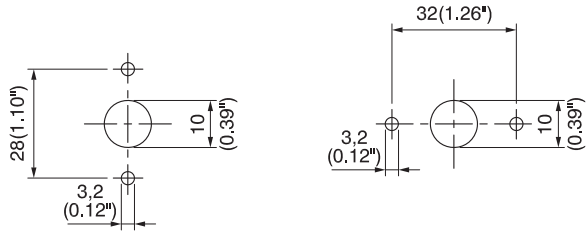

(GT - GY - GV - GW - GL - GK - GR0)

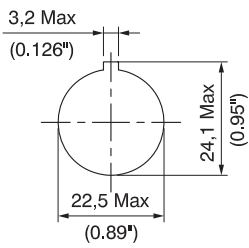

(RV6/RV6-T - RW6/RW6-T - RL5 - RK5)

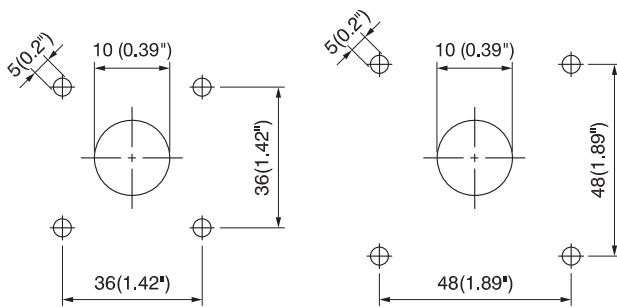

(RV4/RV4-T - RW4/RW4-T)

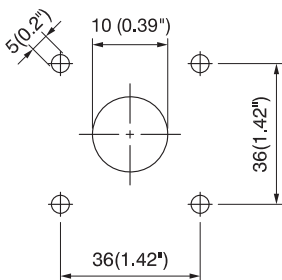

## ■ Base mounting

(BT - BY - BV - BW - BL - BK) - Measures in mm (in)

Escutcheon plate mounting options:

- 1) 2 holes with vertical distance 28mm (1.10")
- 2) 2 holes with horizontal distance 32mm (1.26")

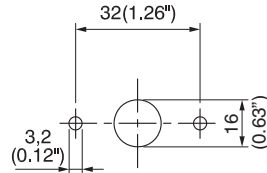
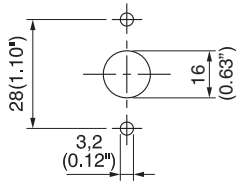

Switch mounting options:

- 1) 2 holes with distance 58mm (2.28") - 72mm (2.83")
- 2) snap mount on DIN 46277/3 rail

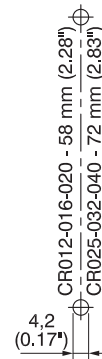

(HT - HY - HV - HW - HL - HK)

Escutcheon plate

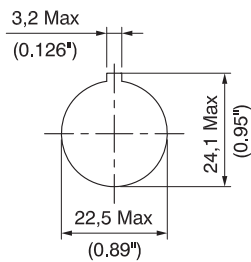

Switch mounting options:

- 1) 2 holes with distance 58mm (2.28") - 72mm (2.83")
- 2) snap mount on DIN 46277/3 rail

