

**Panel mounted inlet - Part no. 832**

- screw terminals
- nickel plated contacts
- a retaining nose to hold the hinged lid of the connector must be provided by the customer in order to ensure satisfactory locking

Protection type	IP 67
Ampere	32 A
Poles	4p
Voltage	400
Hertz	50-60Hz
Earth position	6h
Contact	standard
Connection technology	Screw terminals

Std. Pack. 10 Qty.

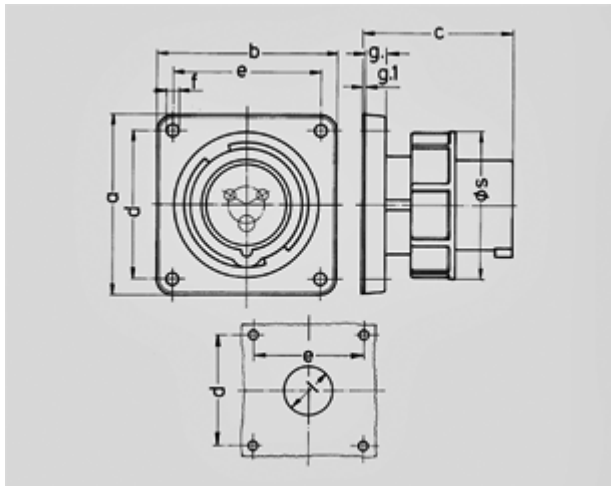

Drawing	Amp.	16			32		
		3	4	5	3	4	5
2 MB 187/2	Poles						
Dim. in mm	a	85,7	85,7	85,7	85,7	85,7	85,7
	b	85,7	85,7	85,7	85,7	85,7	85,7
	c	72	72	72	90	90	90
	d	69,5	69,5	69,5	69,5	69,5	69,5
	e	69,5	69,5	69,5	69,5	69,5	69,5
	f	5,5	5,5	5,5	5,5	5,5	5,5
	g.	11	11	11	11	11	11
	g.1	2	2	2	2	2	2
	l	32	36	47	47	47	47
	s	71	79	89	94	94	102
	Terminal for cond. cross section (mm <sup>2</sup> ) min.-max.	1,5	1,5	1,5	2,5	2,5	2,5
		-4	-4	-4	-10	-10	-10