

15.3 - CAJA REDONDA USO RUDO A PRUEBA DE INTEMPERIE. 114 (4 1/2). SERIE VMX.

15.3 - WEATHERPROOF HEAVY DUTY 4 1/2 (114) ROUND OUTLET BOX. VMX SERIES.

FICHA TECNICA / TECHNICAL DATA

007 - RW - 276

- Material: Aluminio inyectado a presión (diecast).
- Acabados: Pintura electrostática epoxica/Poliester polimerizada.
- A prueba de intemperie cuando se usa tapa con empaque. NEMA 4, 4X
- Rosca NPT para usarse con tubo conduit RIGIDO e IMC.
- Se surte con 5 bocas roscadas y 4 tapones roscados.
- Medidas de bocas: 12.7 (1/2), 19.05 (3/4), 25.4 (1).
- Tornillo de tierra pasivado incluido.
- 4 agujeros para montaje.
- Los agujeros sin salida para los tornillos de la tapa evitan daños al cable durante la instalación y asegura la caja a prueba de agua.

APLICACIONES.

- Para montaje suspendido o a pared en luminarias H.I.D. **Serie VM** y otros tipos de lamparas.
- En instalaciones de tubo conduit RIGIDO e IMC. Permite facil acceso para mantenimiento.
- Fabricación en base a: UL 514 A
CAN/CSA-C22.2 No. 18-92

- Material: Diecast aluminum.
- Finish: Electrostatic powder epoxy/Poliester coating.
- For wet locations when gasketed cover are used. NEMA 4, 4X
- NPT threaded for use with RIGID and IMC conduit.
- Furnished with 5 tapped holes and 4 threaded close-up plugs.
Hub sizes: 1/2 (12.7), 3/4 (19.05), 1 (25.4).
- Green ground screw included.
- Four mounting holes.
- Blank cover screw holes prevent conductor damage during installation, provide water-tightness.

APPLICATIONS.

- For pendant or wall mounting in H.I.D. **VM Series** and other lighting fixtures.
- In installations of threaded RIGID and IMC conduit. Provide openings for making splice and taps. Allows access for maintenance.
- Manufactured in compliance with: UL 514 A
CAN/CSA-C22.2 No. 18-92

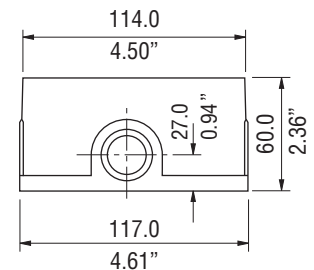
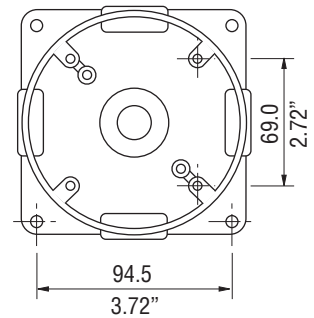

USAR No. DE CODIGO PARA HACER PEDIDOS. TO ORDER USE CODE NUMBER.

Figura Figure	Descripción Description	Catalogo Catalog	Código Code	Salida Hub size		Peso x 100 pzas. Weight x 100 pcs.		Pqt. Unit Pzas. Pcs.	Unit Ctn. Pzas. Pcs.	Ship Ctn. Pzas. Pcs.	Std. Pkg. Pzas. Pcs.
				mm	inch	kg	lb				
	Caja redonda VMX 114 (4 1/2) 5 ø, con 4 tapones.	VMX-10	27.09.3359	12.7	1/2	47.6	104.7				24
	4 (102) CSX round outlet box 5 hubs, with 4 close-up plugs.	VMX-20	27.09.3360	19.0	3/4	47.6	104.7				24
		VMX-30	27.09.3361	25.4	1	47.6	104.7				24
	Tapa redonda ciega TVMX 114 (4 1/2), con empaque y tornillos.	TVMX	27.09.3362			10.0	22.0	1	20	160	
	Tapa redonda TVMX 114 (4 1/2) 1 ø roscado, con empaque y tornillos.	TVMX-10	27.09.3363	12.7	1/2	11.5	25.3	1	6	48	70
	4 1/2 (114) TVMX round one hub cover, with gasket and screws.	TVMX-20	27.09.3364	19.0	3/4	10.0	22.0	1	6	48	70
		TVMX-30	27.09.3365	25.4	1	9.0	19.8	1	6	48	70
	Empaque EVMX 114 (4 1/2). EVMX gasket 4 1/2 (114).	EVMX	27.08.3282			10.0	22.0	10	70	560	
	Tapón roscado.	TA-0371	01.04.0371	12.7	1/2	1.0	2.2	25	200	2000	
	Close-up plug.	TA-0368	01.04.0368	19.0	3/4	1.3	2.9	25	100	1000	
		TA-2632	01.04.2632	25.4	1	1.7	3.7	25	100	1000	

Especificaciones sujetas a cambio sin previo aviso. Specifications are subject to change without notice.

RAWELT, S.A. de C.V.



Cotización/Quotation Plazo de embarque* / Shipment exw* :

 Pedido No./Purchase order : _____

Our ref.: _____

Fecha/Date: _____ Vendedor/Salesman: _____ No. _____

Facturar a/Invoice to: _____ RFC: _____

Ordenado por/Ordered by: _____ Tel. () _____ Fax () _____

Dirección/Address: _____





_____ C.P./Zip. _____ Lugar/City/Country: _____

Consignar a/Ship to: _____

 _____ Embarcar: Camión x Cobrar Pagado Paquete

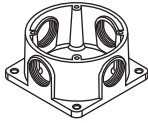
Cond. de Pago/Terms: _____

Cond. de Venta/Sale conditions: _____ L.P.: _____

15.3 - SERIE VMX. CAJA REDONDA USO RUDO A PRUEBA DE INTEMPERIE 114 (4 1/2)									
15.3 - VMX SERIES. WEATHERPROOF HEAVY DUTY ROUND OUTLET BOX. 4 1/2 (114)									
Figura Figure	Código Code	Salida Hub size		Pqt. Unit	Unit Ctn.	Ship Ctn.	Std. Pkg.	Cantidad Qty.	<input type="checkbox"/> Expediente
		mm	inch	Pzas. Pcs.	Pzas. Pcs.	Pzas. Pcs.	Pzas. Pcs.		
	27.09.3359	12.7	1/2				24		<input type="checkbox"/> Control
	27.09.3360	19.0	3/4				24		
	27.09.3361	25.4	1				24		
	27.09.3362			1	20	160			<input type="checkbox"/> Embarques
	27.09.3363	12.7	1/2	1	6	48	70		<input type="checkbox"/> Almacén
	27.09.3364	19.0	3/4	1	6	48	70		
	27.09.3365	25.4	1	1	6	48	70		
	27.08.3282			10	70	560			<input type="checkbox"/> Producción
	01.04.0371	12.7	1/2	25	200	2000			<input type="checkbox"/>
	01.04.0368	19.0	3/4	25	100	1000			
	01.04.2632	25.4	1	25	100	1000			

- Antes de fincar el pedido en firme, favor de confirmar con fábrica el plazo de embarque definitivo.
- Before place your order, please confirm with RAWELT definitive date of shipment.