

Wall mounted socket - Part no. 1205

- screw terminals
- four external fixing holes
- one cable entry at top and one blind cable entry (can be cut out) at bottom
- sockets are designed for adding an auxiliary contact switch

Protection type	IP 67
Ampere	32 A
Poles	4p
Voltage	230
Hertz	50-60Hz
Earth position	9h
Contact	standard
Connection technology	Screw terminals

Std. Pack. 10 Qty.

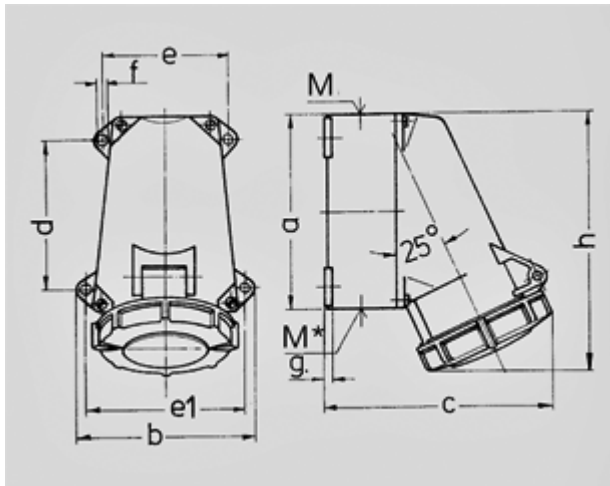

Drawing	Amp.	16			32		
		3	4	5	3	4	5
1 MB 219	Poles						
Dim. in mm	a	95	95	95	120	120	120
	b	102	102	102	112	112	112
	c	115	124	129	143	143	150
	d	64,2	64,2	64,2	90,2	90,2	90,2
	e	77,5	77,5	77,5	79	79	79
	e1	88	88	88	98,5	98,5	98,5
	f	5,5	5,5	5,5	5,5	5,5	5,5
	g	5	5	5	5	5	5
	h	128	128	132	160	160	160
	M	25	25	25	32	32	32
	M*	25	25	25	M32 (blind)		
		(blind) to be cut out			to be cut out		
	Max. cable diam. (mm)	15	18	18	25	25	25
	Terminal for cond. cross section (mm²) min.-max.	1,5	1,5	1,5	2,5	2,5	2,5
		-4	-4	-4	-10	-10	-10