

Panel mounted socket - Part no. 219A

- screw terminals
- straight

| | |
|-----------------------|-----------------|
| Protection type | IP 67 |
| Ampere | 16 A |
| Poles | 3p |
| Voltage | 400 |
| Hertz | 50-60Hz |
| Earth position | 9h |
| Contact | standard |
| Connection technology | Screw terminals |

Std. Pack. 10 Qty.

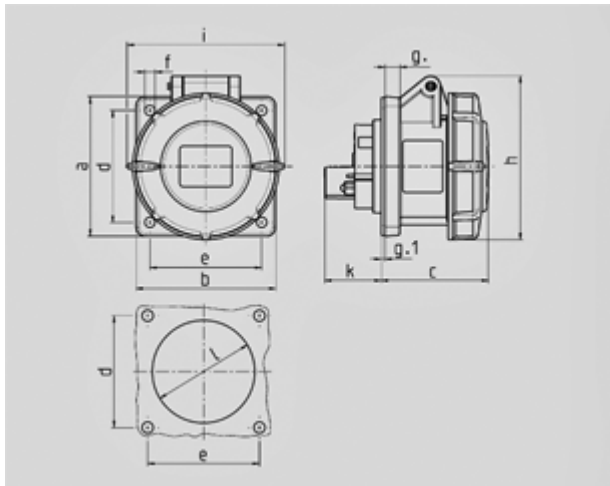

| Drawing | Amp. | 16 | | | 32 | | |
|-------------------|--|-----|-----|-----|-----|-----|-----|
| | | 3 | 4 | 5 | 3 | 4 | 5 |
| 1 MB 141 | Poles | | | | | | |
| Dim. in mm | a | 75 | 75 | 75 | 85 | 85 | 85 |
| | b | 75 | 75 | 75 | 75 | 75 | 75 |
| | c | 60 | 61 | 61 | 70 | 70 | 72 |
| | d | 60 | 60 | 60 | 60 | 60 | 60 |
| | e | 60 | 60 | 60 | 60 | 60 | 60 |
| | f | 5.5 | 5.5 | 5.5 | 5.5 | 5.5 | 5.5 |
| | g | 8 | 8 | 8 | 8 | 8 | 8 |
| | g.1 | 2 | 2 | 2 | 2 | 2 | 2 |
| | h | 83 | 88 | 95 | 99 | 99 | 105 |
| | i | 78 | 85 | 96 | 103 | 103 | 110 |
| | k | 31 | 32 | 32 | 39 | 39 | 39 |
| | l | 43 | 52 | 54 | 58 | 58 | 65 |
| | Terminal for cond. cross section (mm²) min.-max. | 1.5 | 1.5 | 1.5 | 2.5 | 2.5 | 2.5 |
| | | -4 | -4 | -4 | -10 | -10 | -10 |