



CAJA DE PASE PVC SIN CHUPÓN

Características del material:

Impacto, calor, baja temperatura y resistencia química, excelente electricidad.

rendimiento y brillo superficial, etc.

Certificados: CE, ROHS

Nivel de protección: IP65

Temperatura de trabajo: -40°C - 80 °C

Material:: abdominales (ABS)

uso:

Adecuado para interior y exterior eléctrico, comunicación, fuego, aparatos de lucha, fundición de hierro y acero, industria petroquímica, Electrón, sistema de energía, ferrocarril, edificio, mina, puerto aéreo y marítimo, hotel,barco, obras, equipos de tratamiento de aguas residuales, ambiental equipo y así sucesivamente.

Instalación:

1.Interior: hay orificios de instalación en la base para placa de circuito o riel DIN.

2.Fuera: los productos se pueden fijar directamente en la pared u otras tablas planas con tornillos o clavos a través de los orificios para tornillos en la base.

Agujero exterior:

La placa de plástico en el orificio se puede quitar e instalar el prensaestopas para obtener un mejor rendimiento a prueba de agua.

FICHA TÉCNICA

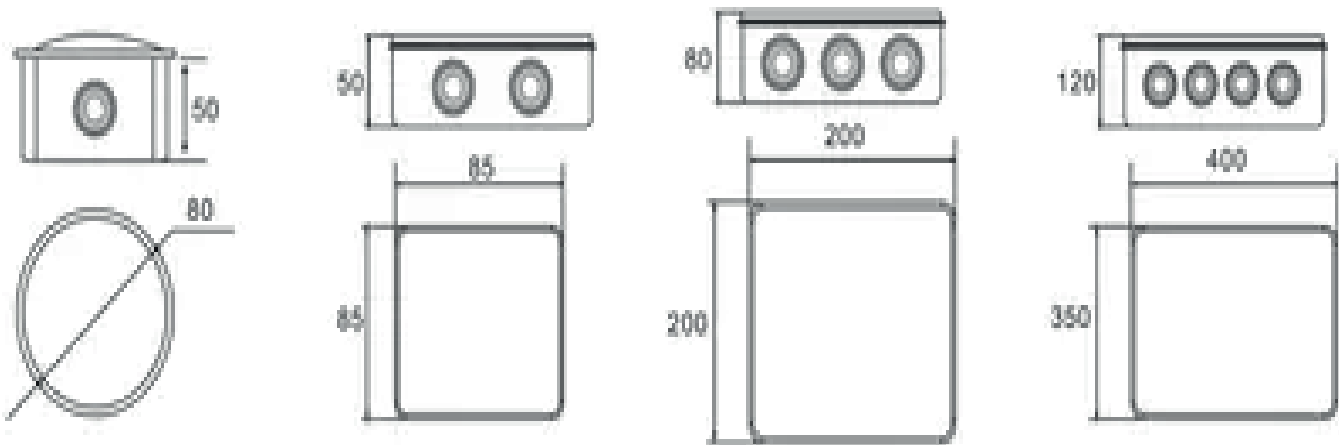

Código Interno	Código de modelo	Agujero	Agujero	IP	GRAMO.	NORTE.	Cant. / Caja	Caja de cartón
		Cant.	Talla		Peso (kilogramo)	Peso (kilogramo)		Dimensión (cm)
RFA-10110	RFA 50x50	4	25	55	13,5	12,3	300	46x38x51
RFA-10111	RFA 80x50	4	25	55	14,7	13,4	240	53x35x62
RFA-10112	RFA 85x85x50	7	25	55	17.2	16,0	200	53x41x53
RFA-10113	RFA 100x100x70	7	25	65	14,9	13,5	100	62x49x35
RFA-10114	RFA 150x110x70	10	25	65	15,1	13,8	60	67x33,5x46,5
RFA-10115	RFA 150x150x70	8	25	65	16,3	15	60	84,5 x 34 x 45
RFA-10116	RFA 200x100x70	8	25	65	16.6	15,3	60	61x46x42
RFA-10117	RFA 200x155x80	10	36	65	14,5	13,2	40	69,5x43,5x42
RFA-10118	RFA 200x200x80	12	36	65	18,0	16.6	40	90x46x40,5
RFA-10119	RFA 255x200x80	12	36	65	21,9	20,1	40	55x45x78,5
RFA-10120	RFA 255x200x120	12	36	65	21,9	20,1	30	64 x 55 x 62
RFA-10121	RFA 300x250x120	12	36	65	20,3	18,4	20	61,5 x 55,5 x 63
RFA-10122	RFA 400x350x120	16	36	65	15	13,3	10	74,5 x 42,5 x 61,5



RT50X50

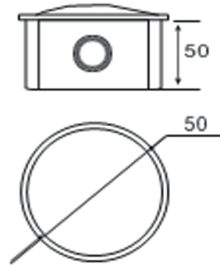

RT80X50

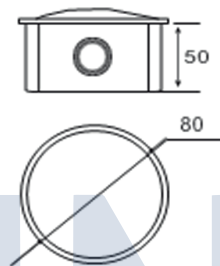

RT85X85X50

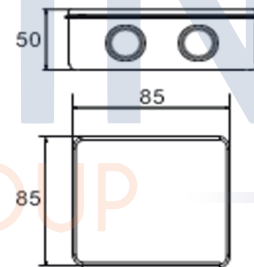

RT100X100X70MM

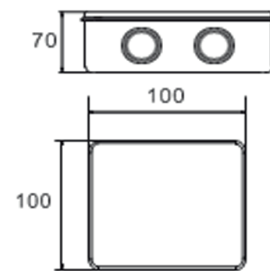

RT150X110X70MM

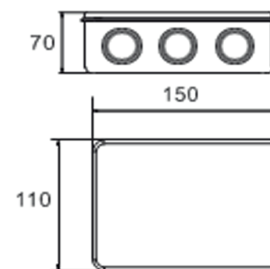

RT150X150X70MM

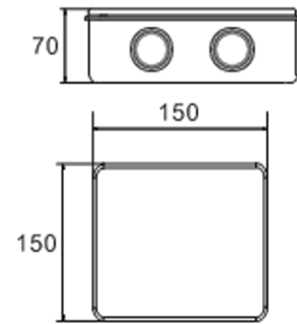

RT200X100X70MM

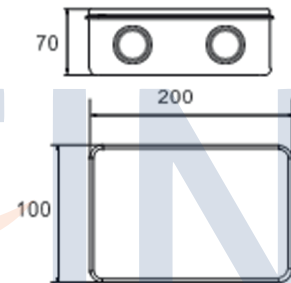

RT200X155X80MM

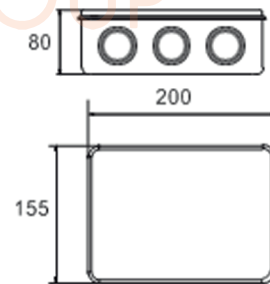

RT200X200X80MM

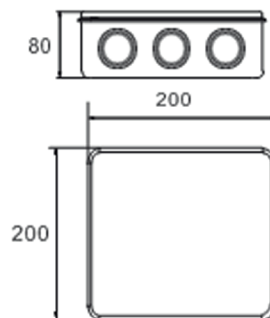



RT255X200X80MM



RT255X200X120MM



RT300X250X120MM



RT400X350X120MM

