

**Panel mounted socket - Part no. 1475**

- screw terminals
- 20° inclination
- 32A receptacles optional fitted with auxiliary contact

Protection type	IP 67
Ampere	16 A
Poles	3p
Voltage	230
Hertz	50-60Hz
Earth position	6h
Contact	standard
Connection technology	Screw terminals

Std. Pack. 10 Qty.

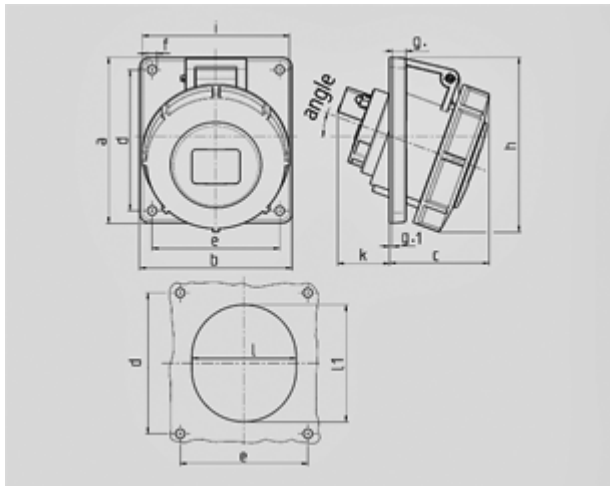

Drawing	Amp.	16			32		
		3	4	5	3	4	5
<b>1 MB 251</b>	<b>Poles</b>						
<b>Dim. in mm</b>	<b>a</b>	73,5	100	100	100	100	100
	<b>b</b>	64	92	92	92	92	92
	<b>c</b>	52	60	62	64	64	66
	<b>d</b>	60	85	85	85	85	85
	<b>e</b>	52	77	77	77	77	77
	<b>f</b>	5,5	5,5	5,5	5,5	5,5	5,5
	<b>g</b>	8	8	8	8	8	8
	<b>g.1</b>	2	2	2	2	2	2
	<b>h</b>	84	100	105	109	109	113
	<b>i</b>	78	85	96	103	103	110
	<b>k</b>	43	32	32	53	53	45
	<b>l</b>	52	55	65	67	67	72
	<b>ll</b>	60	63	72	82	82	85
	<b>α</b>	20°	20°	20°	20°	20°	20°
<b>Terminal for cond. cross section (mm²) min.-max.</b>		1,5	1,5	1,5	2,5	2,5	2,5
		-4	-4	-4	-10	-10	-10