

Wall mounted receptacle - Part no. 1372



- screw terminals
- external fixing
- cable entry at top

Technical information

Ampere	32 A
Poles	4 p
Voltage	230V
Earth position	9 h
Hertz	50-60 Hz
Connection technology	Screw terminals
Contact	standard
Protection type	IP 44

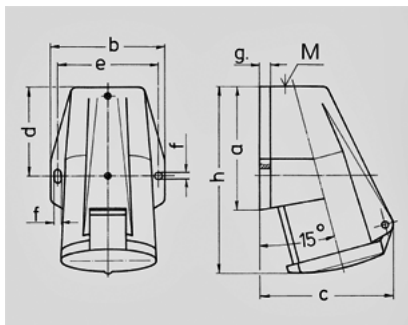

Drawing 1 MB 205	Amp. Poles	16			32		
		3	4	5	3	4	5
Dim. in mm	a	91	91	91	102	102	102
	b	73	79	87	89	89	94
	c	86	93	99	108	108	114
	d	55	55	56,4	62	62	62
	e	62	68	76	77,5	77,5	84
	f	5,3	5,3	5,3	5,3	5,3	5,3
	g	8	8	9	10	10	10
	h	132	132	132	153	153	153
	M	20	25	25	25	25	32
	Max. cable diam. (mm)	13	18	18	18	18	25
	Terminal for cond. cross section (mm²) min.-max.	1,5	1,5	1,5	2,5	2,5	2,5
		-4	-4	-4	-10	-10	-10