







Approval		CE	
Electrical			
Standard	UL	IEC	
Rated voltage	600V	800V	
Rated current	6.3A	6.3A	
Wire size	24-12AWG	0.2-4.0mm ²	
T/W/End plate	8.2/72.5/-mm		
Height(NS35:7.5/NS35:15/NS32)	56.5/64/61.5mm		
Rated surge voltage/Contamination class	6KV/3		
Stripping length	8mm		
Screw thread/Tightening torque	M3/0.5N.m/4.5Lb-in		
Internal cylindrical gage	A4		
Insulating material/Inflammability class	PA/V-0		
Specification		Model	Pieces
(1)Fuse terminal block		PC 4-HE	50
(2)Insertion bridge 		EB 2-8	100
		EB 3-8	50
		EB 10-8	10
(3)Test plug socket insulated 			
(4)Zack strip 		ZB8	

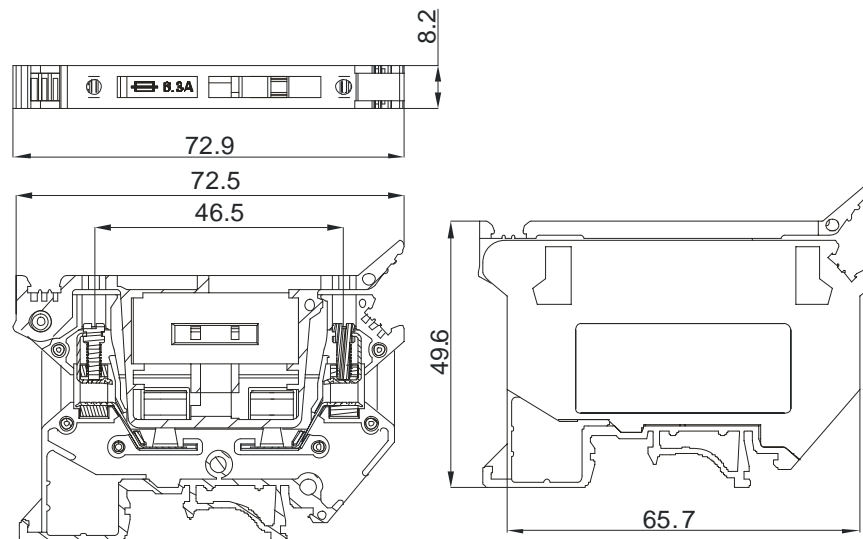
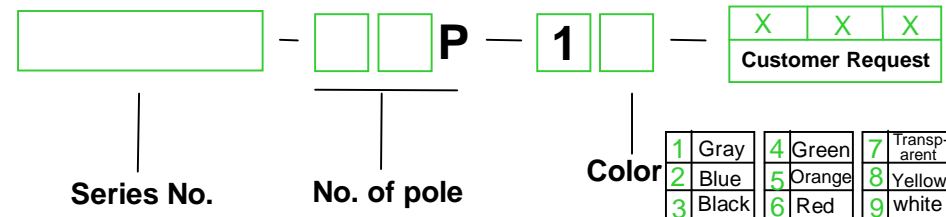

HOW TO ORDER :

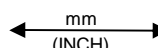

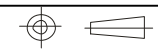
 mm (INCH)	 DEGSON ELECTRONICS CO., LTD.
 THROANGLE PROJECTION	NAME PC 4-HE