

Base mural - N° de Ref. 1178

- Contacto roscado
- Fijación exterior
- Entrada de cables superior

Información sobre el técnica

Amperios	16 A
Polos	3p
Voltios	230V
Sentido horario	6 h
Hertzios	50-60 Hz
Técnica de conexión	bornas de tornillo
Contactos	estándar
Grado de protección	IP 44

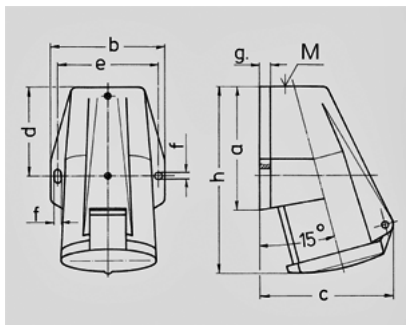

Plano 1 MB 205	Amp. Polos	16			32		
		3	4	5	3	4	5
Dim. en mm	a	91	91	91	102	102	102
	b	73	79	87	89	89	94
	c	86	93	99	108	108	114
	d	55	55	56,4	62	62	62
	e	62	68	76	77,5	77,5	84
	f	5,3	5,3	5,3	5,3	5,3	5,3
	g	8	8	9	10	10	10
	h	132	132	132	153	153	153
	M	20	25	25	25	25	32
Ø y [max]		13	18	18	18	18	25
Borna para cond. Sección		1,5	1,5	1,5	2,5	2,5	2,5
Transvers. (mm²) min.-max.		-4	-4	-4	-10	-10	-10