

Plug AM-TOP® - Part no. 265

- screw terminals
- single part body
- cable gland and sealing
- strain relief and protection against kinking

Protection type	IP 44
Ampere	32 A
Poles	4p
Voltage	500
Hertz	50-60Hz
Earth position	7h
Contact	standard
Connection technology	Screw terminals



Std. Pack. 10 Qty.

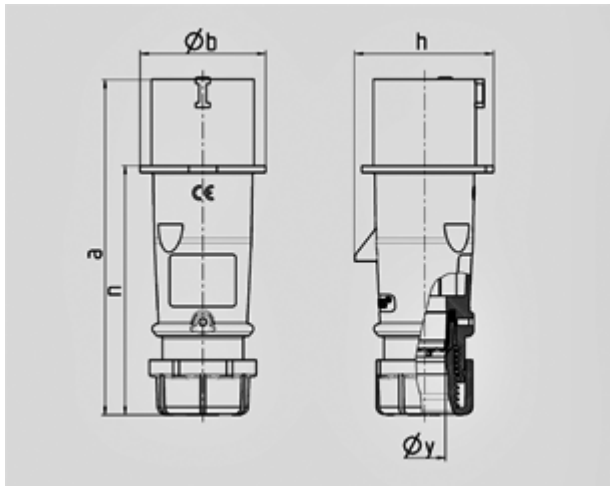

Drawing	Amp.	16			32		
		3	4	5	3	4	5
2 MB 217	Poles						
Dim. in mm	a	142	147	147	186	186	180
	b	53	59	67	70	70	77
	h	59	69,4	76	81	81	89,5
	n	105,2	110,5	110,5	141	141	135
	y	14,5	16	16	22	22	22
Terminal for cond. cross		1	1	1	2,5	2,5	2,5
section (mm ²) min.-max.		-2,5	-2,5	-2,5	-6	-6	-6