

# CAJA DE CONEXIONES IMPERMEABLE (CON TAPON )

Características del material:

Impacto, calor, baja temperatura y resistencia química, excelente electricidad.

rendimiento y brillo superficial, etc.

Certificados: CE, ROHS

Nivel de protección: IP65

Temperatura de trabajo: -40°C - 80 °C

Material:: abdominales (ABS)

uso:

Adecuado para interior y exterior eléctrico, comunicación, fuego. aparatos de lucha, fundición de hierro y acero, industria petroquímica, Electrón, sistema de energía, ferrocarril, edificio, mina, puerto aéreo y marítimo, hotel,barco, obras, equipos de tratamiento de aguas residuales, ambiental equipo y así sucesivamente.

Instalación:

1.Interior: hay orificios de instalación en la base para placa de circuito o riel DIN.

2.Fuera: los productos se pueden fijar directamente en la pared u otras tablas planas

con tornillos o clavos a través de los orificios para tornillos en la base.

Agujero exterior:

La placa de plástico en el orificio se puede quitar e instalar el prensaestopas para obtener un mejor rendimiento a prueba de agua.

## FICHA TÉCNICA

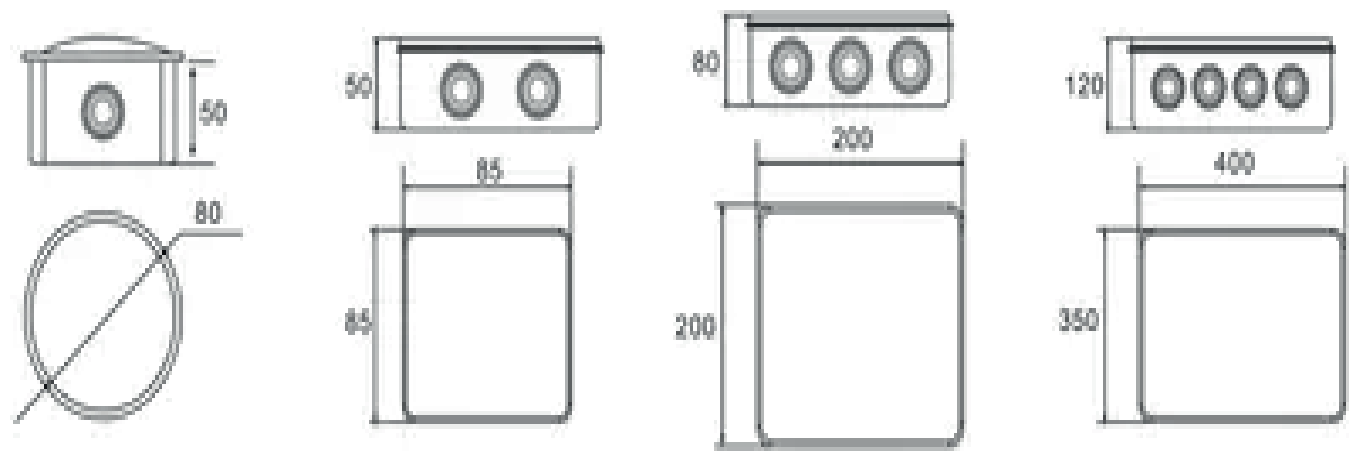

Codigo Sap	Codigo Interno	Código de modelo	Agujero Cant.	Agujero Talla	IP	Longitud mm	Ancho mm	Altura mm	Cant. / Caja	Modelo de caja
016715	CHP-10110	RFA 50x50	4	25	55	50	50	/	300	Modelo de caja tipo cilindro
016716	CHP-10111	RFA 80x50	4	25	55	80	50	/	240	
016717	CHP-10112	RFA 85x85x50	7	25	55	85	85	50	200	Modelo de caja tipo rectangular/cuadrado
016718	CHP-10113	RFA 100x100x70	7	25	65	100	100	70	100	
016719	CHP-10114	RFA 150x110x70	10	25	65	150	110	70	60	
016720	CHP-10115	RFA 150x150x70	8	25	65	150	150	70	60	
016721	CHP-10116	RFA 200x100x70	8	25	65	200	100	70	60	
016722	CHP-10117	RFA 200x155x80	10	36	65	200	155	80	40	
016723	CHP-10118	RFA 200x200x80	12	36	65	200	200	80	40	
016724	CHP-10119	RFA 255x200x80	12	36	65	255	200	80	40	
016725	CHP-10120	RFA 255x200x120	12	36	65	255	200	120	30	
016726	CHP-10121	RFA 300x250x120	12	36	65	300	250	120	20	
016727	CHP-10122	RFA 400x350x120	16	36	65	400	350	120	10	

**XL-RA 50X50**

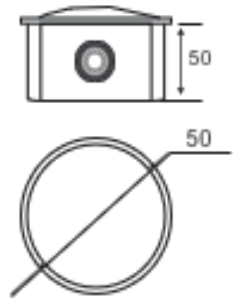

**XL-RA 80X50**

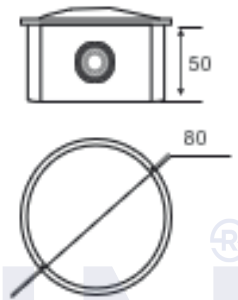

**XL-RA 85X85X50**

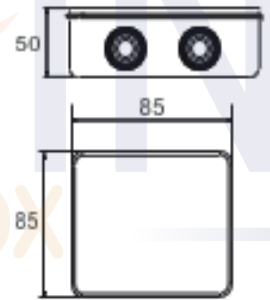

**XL-RA 100X100X70**

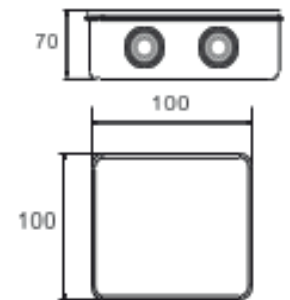

**XL-RA 150X110X70**

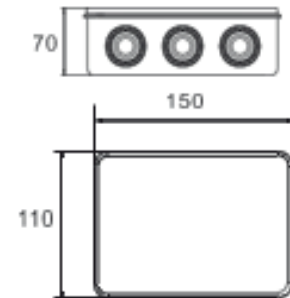

**XL-RA 150X150X70**

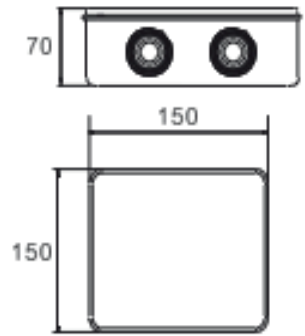

**XL-RA 200X100X70**

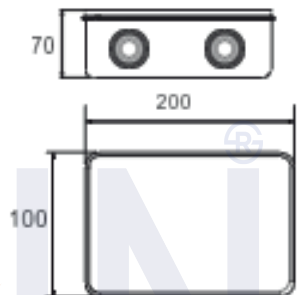
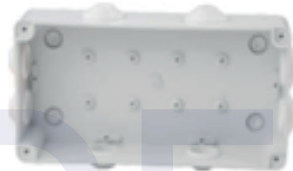

**XL-RA 200X155X80**

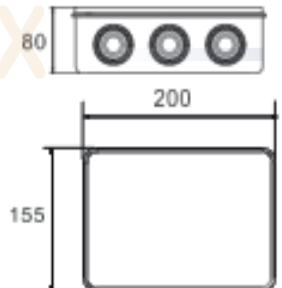

**XL-RA 200X200X80**

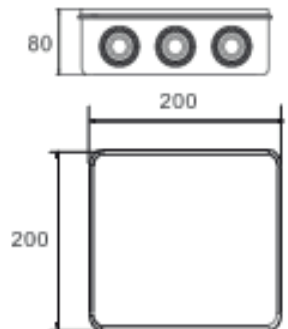

XL-RA 255X200X80

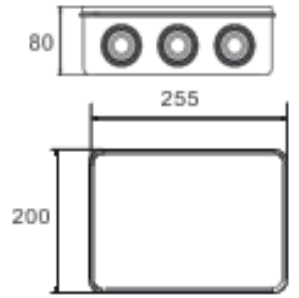

XL-RA 255X200X120

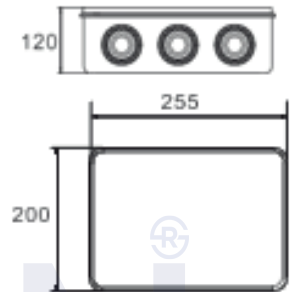

XL-RA 300X250X120

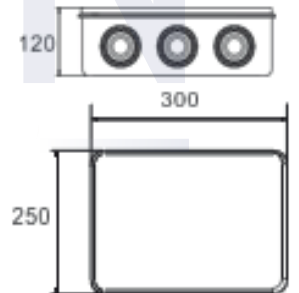

XL-RA 400X350X120

