

KSS

2019/2020

MADE IN TAIWAN

ISO 9001
ISO 14001
IATF 16949
OHSAS 18001



SINCE 1969



WIRING ACCESSORIES



KAI SUH SUH ENTERPRISE CO., LTD.



▲KSS Taipei Head Office Complex(12 Floors)

KSS

KAI SUH SUH ENTERPRISE CO., LTD.

KSS, KAI SUH SUH ENTERPRISE CO., LTD. was established in 1969, as the leading manufacturer of cable ties and wiring accessories in Asia, with 4 branch offices in Taiwan serving more than 20,000 accounts in Taiwan and 126 countries in the world with our own brand "KSS".

KSS is an ISO 9001 & ISO 14001 & OHSAS 18001 & IATF 16949 certificated company, adapting the most hightech and computer-controlled injection and extrusion machines to produce over 1000 kinds of products whose quality has been approved by UL, CSA, VDE, DNV.GL, LLOYD, CE, ABS, IP68 and RoHS etc. All of them ensure the "FAST" & "SAFE" application of KSS wiring accessories for the electrical & electronics wiring. KSS is the only manufacturer supporting you with full competitiveness.



YEAR ESTABLISHED :1969
EMPLOYEE : 600
PLANT SIZE : 500,000 M² (UTILIZED)



▲MANUFACTURING PLANT & LOGISTIC CENTER



▲MANUFACTURING PLANT



▲MANUFACTURING PLANT



▲MANUFACTURING PLANT



▲LOGISTIC CENTER



KSS COMPANY ORGANIZATION

HEAD OFFICE :
 38, YEN PING N. RD., SEC. 1,
 TAIPEI 103, TAIWAN
 TEL:886-2-2556-3336 (15 LINES)
 2558-3336 (5 LINES)
 FAX:886-2-2556-1399 (5 LINES)
 http://www.kss.com.tw
 E-mail:kss02@mail.kss.com.tw

INTERNATIONAL DEPARTMENT :
 38, YEN PING N. RD., SEC. 1,
 TAIPEI 103, TAIWAN
 TEL:886-2-2555-1929 (9 LINES)
 FAX:886-2-2556-0052 (5 LINES)
 http://www.kss.com.tw
 E-mail:kss@mail.kss.com.tw

TAICHUNG BRANCH OFFICE :
 129, KUNG YIH RD.,
 TAICHUNG 403 TAIWAN
 TEL:886-4-2301-1255 (8 LINES)
 FAX:886-4-2302-1313

TAINAN FACTORY :
 23-1, DU-CHIA, CHI-KU DIST.,
 TAINAN CITY, 724 TAIWAN
 TEL:886-6-787-4636
 FAX:886-6-787-1399

KSS PRIVATE INDUSTRIAL PARK :
 138, DU-CHIA, CHI-KU
 DIST, TAINAN 724 TAIWAN
 TEL:886-6-787-2139
 FAX:886-6-787-2289

TAINAN BRANCH OFFICE :
 23, DU-CHIA, CHI-KU
 DIST, TAINAN
 724 TAIWAN
 TEL:886-6-787-2239
 FAX:886-6-787-4388

TAINAN SHIH KONG FACTORY :
 20-3, JHONG JHOU,
 CING AN, SIGANG
 DIST, TAINAN 723
 TAIWAN
 TEL:886-6-796-1899
 FAX:886-6-795-4456

TAINAN CENTRAL LOGISTICS :
 120-8, DU-CHIA, CHI-KU
 DIST, TAINAN 724 TAIWAN
 TEL:886-6-787-5169(7 LINES)
 FAX:886-6-787-5239

KAOHSIUNG BRANCH OFFICE :
 116, BO AI 1 RD.,
 KAOHSIUNG 807 TAIWAN
 TEL:886-7-323-1488 (10 LINE)
 FAX:886-7-323-3849



<http://www.kss.com.tw>

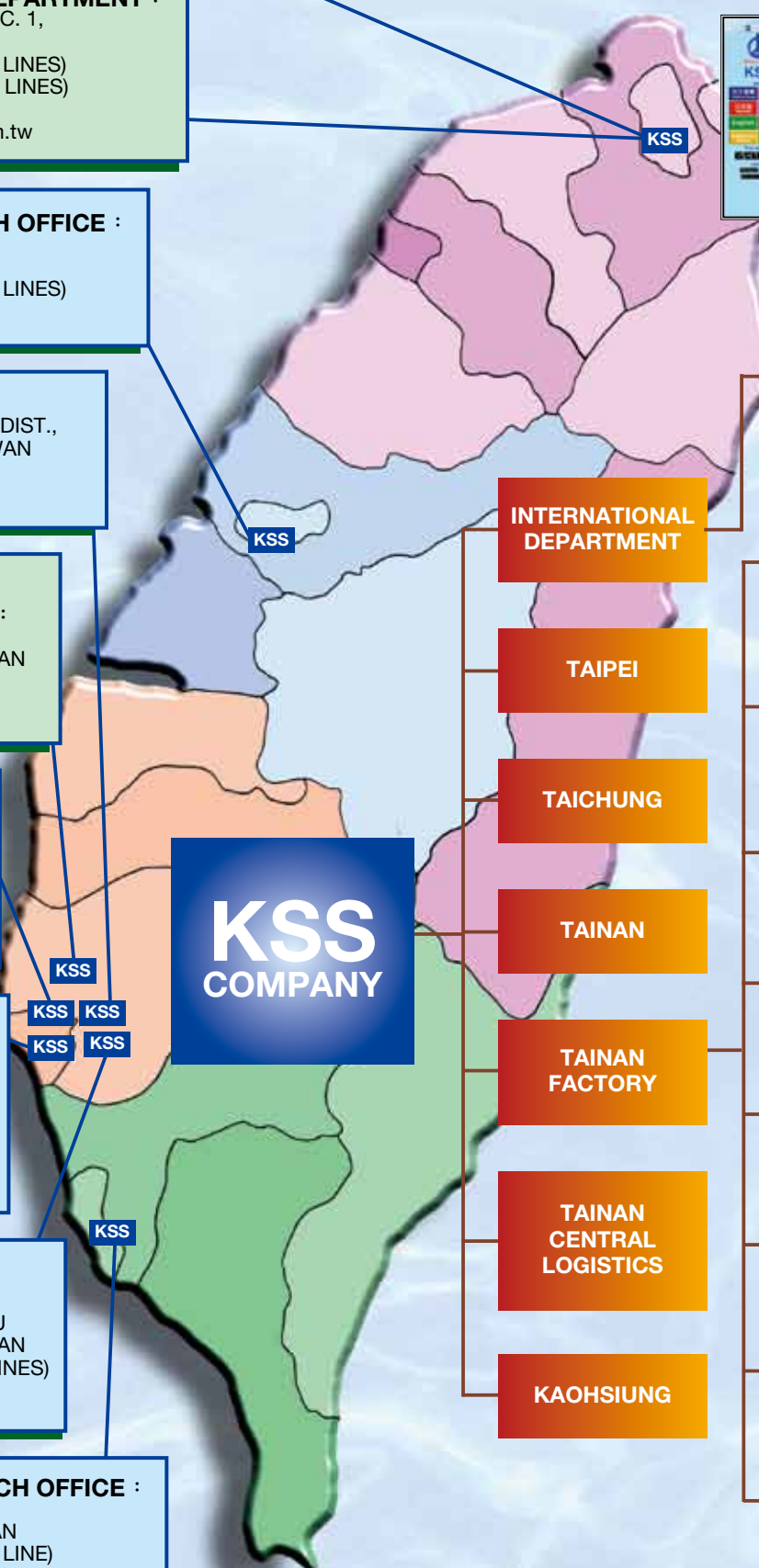

- INTERNATIONAL DEPARTMENT
- TAIPEI
- TAICHUNG
- TAINAN
- TAINAN FACTORY
- TAINAN CENTRAL LOGISTICS
- KAOHSIUNG

- OVERSEAS AGENTS/DIST.(S)
- SALES DEPARTMENT
- EXTRUSION DEPARTMENT
- INJECTION DEPARTMENT
- HOT STAMPING
- ACRYLIC ENGRAVING
- VINYL COATING
- MOSAIC PANEL
- TOOLING DEPARTMENT



KSS CORPORATION HISTORY

KSS WAS ESTABLISHED IN TAIPEI. KSS FACTORY WAS OPENED IN TAINAN.

- 1969** — TO START THE MANUFACTURING OF WIRING ACCESSORIES, WIRING DUCTS AS THE FIRST PRODUCT WAS STARTED.
- 1970** — THE PRODUCTION OF 'O TYPE' AND 'C TYPE' CABLE MARKER STARTED.
- 1971** — SPIRAL WRAPPING BAND STARTED.
- 1972** — EXTRUSION DEPARTMENT STARTED.
- 1973** — INJECTION DEPARTMENT STARTED.
- 1974** — BOUGHT NEW TAIPEI OFFICE ON CHUNG CHING N. RD. PLANT SIZE EXPANDED TO 2880 SQ FT.
- 1975** — EXTRUSION DEPARTMENT EXPANDED AGAIN
- 1976** — PLANT SIZE EXPANDED TO 7200 SQ FT.
- 1977** — TAINAN OFFICE BUILDING COMPLETED.
- 1978** — KAOHSIUNG BRANCH OFFICE STARTED.
- 1979** — EXPORT BUSINESS STARTED.
- 1980** — EC MARKER MANUFACTURING STARTED.
- 1981** — INJECTION DEPARTMENT STARTED.
INSTALLED TELEX MACHINE TO EXPEDITE COMMUNICATION
- 1982** — ARCYLIC ENGRAVING DEPARTMENT STARTED .
- 1983** — TAICHUNG BRANCH OFFICE OPENED.
TAIPEI HEAD OFFICE NEW BUILDING OPENED. CAPITAL INCREASED TO NT\$5,000,000.
- 1984** — EXPORT DEPARTMENT OFFICIALLY ESTABLISHED.
- 1985** — TAINAN NEW OFFICE BUILDING OPENED.(10800 SQ FT).
INSTALLED FAX MACHINE TO EXPEDITE COMMUNICATION.
- 1986** — CAPITAL INCREASED TO NT\$11,000,000.
INSTALLED COMPUTER TO COMPLETE OA EQUIPMENT.
- 1987** — LUMI-GRAPHIC STARTED.
- 1988** — KSS 2ND FACTORY BUILDING STARTED. KAOHSIUNG NEW OFFICE BUILDING OPENED.
- 1989** — CAPITAL INCREASED TO NT\$21,000,000. INSTALL COMPUTER ENGRAVING PRINTING SYSTEM.
- 1990** — CAPITAL INCREASED TO NT\$29,000,000. CENTRAL WAREHOUSE OPERATED. TOLLING DEPARTMENT STARTED.
CAPITAL INCREASED TO NT\$45,000,000.
- 1991** — CENTRAL WAREHOUSE EXPANDED 108,000 SQ FEET.
KAOHSIUNG OFFICE EXPANDED TO 12960 SQ FEET.
- 1992** — DOUBLE EXPANSION OF TAICHUNG BRANCH.
- 1993** — EXPANSION OF MANUFACTURING PLANT COMPLETED SPONSOR OF WIRING ACCESSORIES IN 32ND INTERNATIONAL VOCATIONAL TRAINING COMPETITIONS HELD IN TAIPEI 1993.
- 1994** — REPRESENT SUMITUBE IN TAIWAN. TC.TF SERIES QUALIFY UL STANDARD. CABLE GLAND QUALIFY IP-68 STANDARD.
- 1995** — EXPANSION OF 3RD PLANT TO 54,000 SQ FEET
EXPANSION OF 4TH PLANT TO 36,000 SQ FEET
- 1996** — TAIPEI OFFICE COMPLEX 21,600 SQFT COMPLETED.
ISO 9002 CERTIFICATED.
- 1997** — BUILD 5TH PLANT 36,000 SQ FEET.
- 1998** — START TO MANUFACTURE FLEXIBLE CONDUIT.
CONSTRUCTION OF 6TH PLANT STARTED.
- 1999** — INSTALL 20 SETS OF FASTENER COMPONENTS SPECIALIZED INJECTION MACHINE.
- 2000** — 6TH PLANT JOIN SERVICE
- 2001** — RE-CONSTRUCTION OF 2ND PLANT COMPLETED.
BUILD AUTOMATIC WAREHOUSE/LOGISTIC CENTER.
- 2002** — INSTALL ERP(ENTERPRISE RESOURCE PLANNING)SYSTEM TO OFFER ON-LINE COMPUTER LINK TO ALL OFFICES/PLANTS.
- 2003** — APPLIED FOR PRIVATE INDUSTRIAL PARK.
- 2004** — PRIVATE INDUSTRIAL PARK APPROVED.
ISO14001 CERTIFICATED.
- 2005** — PRIVATE INDUSTRIAL PARK APPROVED
- 2006** — BUILD 2ND AUTOMATIC WAREHOUSE
BUILD NEW FACTORY AT PRIVATE INDUSTRY PARK 560,000 SQ FEET
- 2007** — KSS PRIVATE INDUSTRY PARK COMPLETED
- 2008** — START TO PRODUCE WIRING DUCT IN LARGE SIZE. (SDH-600100)
- 2009** — KSS APPLIED FOR 2nd DEVELOPMENT OF PRIVATE INDUSTRIAL PARK
- 2010** — INSTALL 21 SETS OF FASTENER COMPONENTS SPECIALIZED INJECTION MACHINE.
AWARDED "TOP 100 TAIWAN BRAND" .
- 2011** — OHSAS 18001 CERTIFICATED.
- 2012** — 2nd PRIVATE INDUSTRIAL PARK APPROVED.
- 2013** — AWARDED three performances of "Enterprise with outstanding performance", "The Best Product" and "Contribution with Excellence" from "THE NATIONAL BRAND YUSHAN AWARD".
- 2014** — AWARDED "TAIWAN EXCELLENT COMPANIES".
ISO/TS 16949 CERTIFICATED.
- 2015** — AWARDED "TAIWAN EXCELLENCE".
- 2016** — AWARDED "TAIWAN EXCELLENCE".
- 2017** — AWARDED "TAIWAN EXCELLENCE".
- 2018** — AWARDED "TAIWAN EXCELLENCE".

KSS BUYERS INTERNATIONAL SALES NETWORK



- | | | | | |
|---------------------------|----------------|----------------|--------------------------|-----------------|
| 1 ALGERIA | 27 ECUADOR | 53 ITALY | 79 NETH ANTILLES | 105 SPAIN |
| 2 ARGENTINA | 28 EGYPT | 54 IVORY COAST | 80 NETHERLANDS | 106 SRI LANKA |
| 3 AUSTRALIA | 29 EL SALVADOR | 55 JAMAICA | 81 NEW CALEDONIA | 107 SUDAN |
| 4 AUSTRIA | 30 ESTONIA | 56 JAPAN | 82 NEW GUINEA | 108 SURINAME |
| 5 AZERBAIJAN | 31 FIJI | 57 JORDAN | 83 NEW ZEALAND | 109 SWEDEN |
| 6 BAHRAIN | 32 FINLAND | 58 KAZAKHSTAN | 84 NIGERIA | 110 SWITZERLAND |
| 7 BANGLADESH | 33 FRANCE | 59 KENYA | 85 NORWAY | 111 SYRIA |
| 8 BELARUS | 34 GEORGIA | 60 KOREA | 86 OMAN | 112 TAIWAN |
| 9 BELGIUM | 35 GERMANY | 61 KOSOVO | 87 PAKISTAN | 113 THAILAND |
| 10 BELIZE | 36 GHANA | 62 KUWAIT | 88 PANAMA | 114 TRINIDAD |
| 11 BOLIVIA | 37 GREECE | 63 LATVIA | 89 PARAGUAY | 115 TUNISIA |
| 12 BOSNIA AND HERZEGOVINA | 38 GUATEMALA | 64 LEBANON | 90 PERU | 116 TURKEY |
| 13 BRAZIL | 39 GUINEA | 65 LITHUANIA | 91 PHILIPPINES | 117 U.A.E. |
| 14 BULGARIA | 40 GUYANA | 66 MACAU | 92 POLAND | 118 U.K. |
| 15 CAMBODIA | 41 HAITI | 67 MADAGASCAR | 93 PORTUGAL | 119 U.S.A. |
| 16 CANADA | 42 HAWAII | 68 MALAWI | 94 PUERTO RICO | 120 UKRAINE |
| 17 CHILE | 43 HONDURAS | 69 MALAYSIA | 95 QATAR | 121 URUGUAY |
| 18 CHINA | 44 HONG KONG | 70 MALDIVES | 96 REPUBLIC OF MACEDONIA | 122 VANUATU |
| 19 COLOMBIA | 45 HUNGARY | 71 MALTA | 97 ROMANIA | 123 VENEZUELA |
| 20 COSTA RICA | 46 ICELAND | 72 MAURITIUS | 98 RUSSIA | 124 VIETNAM |
| 21 CROATIA | 47 INDIA | 73 MEXICO | 99 SAUDI ARABIA | 125 YEMEN |
| 22 CUBA | 48 INDONESIA | 74 MOLDOVA | 100 SERBIA | 126 ZIMBABWE |
| 23 CYPRUS | 49 IRAN | 75 MONGOLIA | 101 SINGAPORE | |
| 24 CZECH | 50 IRAQ | 76 MOROCCO | 102 SLOVAKIA | |
| 25 DENMARK | 51 IRELAND | 77 MOZAMBIQUE | 103 SLOVENIA | |
| 26 DOMINICAN REPUBLIC | 52 ISRAEL | 78 NEPAL | 104 SOUTH AFRICA | |

GENERAL TRADE TERMS :

OUR PRODUCTS ARE WARRANTED TO BE FREE FROM DEFECTS IN MATERIALS AT THE TIME OF SALE BUT OUR OBLIGATION UNDER THIS WARRANTY IS LIMITED TO THE REPLACEMENT OF ANY PRODUCT PROVED TO BE DEFECTIVE WITHIN 3 MONTHS FROM THE DATE OF DELIVERY AND CAN PROVE TO BE THE RESPONSIBILITY OF FACTORY.

NO FURTHER CLAIM, SUCH AS FREIGHT, TAX...ETC. WILL BE ACCEPTED.

BECAUSE OF THE VARIED NATURE OF THE USES OF THESE PRODUCTS EACH USER SHOULD MAKE THEIR OWN EVALUATIONS REGARDING THE SUITABILITY OF THESE PRODUCTS FOR THEIR SPECIFIC APPLICATION.

USER SHALL DETERMINE THE SUITABILITY OF THE PRODUCT FOR HIS INTENDED APPLICATION AND ASSUMES ALL RISKS & LIABILITY WHATSOEVER IN CONNECTION THEREWITH. NEITHER SELLER NOR MANUFACTURER SHALL BE LIABLE FOR ANY INJURY, LOSS, OR DAMAGE, WHETHER DIRECT OR CONSEQUENTIAL, ARISING OUT OF THE USE OF, OR THE INABILITY TO USE, THE PRODUCT.

WIRING DUCTS		WIRING DUCTS		WIRING DUCTS		WIRING DUCTS		CABLE MARKERS		CABLE MARKERS		CABLE TIES		
0101 WIRING DUCT (SLOTTED) P.10	0105 WIRING DUCT CONNECTOR P.19	0113 ONE PIECE WIRING DUCT P.26	0124 CABLE CLIP P.31	0201 EC TYPE CABLE MARKER P.38	0208 FLAT MARKER TUBE P.42	0301 NYLON CABLE TIE P.50,56								
0101 WIRING DUCT (CLOSE SLOTTED) P.12	0105 WIRING DUCT CONNECTOR P.19	0115 TELEPHONE WIRING DUCT CONNECTOR P.26	0127 ROUND TYPE WIRING DUCT WITH ALUMINUM COVER P.31	0201 ECP TYPE CABLE MARKER P.38	0210 MARKER PLATE P.43	0301 METAL DETECTABLE NYLON CABLE TIE P.52								
0101 NON-SLIP WIRING DUCT COVER P.12	0105 WIRING DUCT CONNECTOR P.19	0116 TELEPHONE WIRING DUCT P.27	0125 ROUND TYPE WIRING DUCT P.32	0201 COLOR CODED CABLE MARKER P.39	0212 MARKER BOX P.43	0301 NYLON CABLE TIE (FLAME RETARDANT) P.52								
0101 WIRING DUCT (SLOTTED) P.13	0105 WIRING DUCT COUPLER P.20	0116 TELEPHONE WIRING DUCT CONNECTOR P.28	0125 ROUND TYPE WIRING DUCT CONNECTOR P.32	0201A MARKER BOX P.39	0215 SELF ADHESIVE WIRE MARKER P.44	0301 HEAT STABILIZED NYLON CABLE TIE P.53								
0101 WIRING DUCT (SLOTTED) P.13	0106 WIRING RETAINER P.20	0116 TELEPHONE WIRING DUCT CONNECTOR P.28	0125 ROUND TYPE WIRING DUCT CONNECTOR P.32	0202 FLAT CABLE MARKER P.39	0215 SELF ADHESIVE WIRE MARKER P.44	0301 POLYPROPYLENE CABLE TIE P.53								
0101 WIRING DUCT (SLOTTED) P.14	0107 WIRING SADDLE P.21	0118 TELEPHONE WIRING DUCT P.29	0126 ROUND TYPE WIRING DUCT P.33	0203 MARKER STRIP P.40	0225 OC TYPE CABLE MARKER P.44	0301 UV RESISTANT NYLON CABLE TIE P.54,57								
0104 FLEXIBLE WIRING DUCT P.14	0108 WIRING DUCT P.22	0118 TELEPHONE WIRING DUCT CONNECTOR P.29	0128 SOFT WIRING DUCT P.34	0205 O TYPE CABLE MARKER P.40	0230 CM TYPE CABLE MARKER P.45	0301 EXTRA HEAVY DUTY TIE P.57								
0101 WIRING DUCT (SLOTTED) P.15	0110 WIRING DUCT CONNECTOR P.22	0119 ADHESIVE TAPE P.29	0131 COVERING DUCT P.35	0205 O TYPE MARKER TUBE P.41	0234 MB TYPE CABLE MARKER P.45	0302 TIE GUN P.58								
0105 MINI TRUNKING P.15	0112 DECORATION WIRING DUCT P.23	0119 DOUBLE-COATED FOAM TAPE P.29	0130 SOFT SPLIT - INSERT WIRING DUCT P.35	0205 O TYPE MARKER TUBE P.41	0235 U TYPE CABLE MARKER P.45	0305 MOUNTING CABLE TIE P.58								
0105 WIRING DUCT (SOLID) P.16	0103 ONE PIECE WIRING DUCT CONNECTOR P.24	0120 U TYPE WIRING DUCT P.230	0133 ONE PIECE WIRING DUCT P.36	0205 O TYPE MARKER TUBE P.41	0236 SM TYPE CABLE MARKER P.46	0309 DOUBLE HEAD CABLE TIE P.59								
0105 WIRING DUCT CONNECTOR P.17	0113 ONE PIECE WIRING DUCT P.24	0121 ROUND INSULATING CONDUIT P.30	0133 ONE PIECE WIRING DUCT CONNECTOR P.36	0205 O TYPE MARKER TUBE P.41	0236 SM TYPE COLOR CODED CABLE MARKER P.46	0312 HANDCUFF TIE P.60								
0105 WIRING DUCT P.18	0113 ONE PIECE WIRING DUCT P.25	0122 OVAL INSULATING CONDUIT P.30	0101A WIRING DUCT CUTTER P.11	0205 O TYPE MARKER TUBE P.42			0310 BEAD TIE P.60							
0105 WIRING DUCT P.18	0114 ELECTRICAL BOX P.25	0124 WIRING DUCT & CABLE CLIP P.31			0205 O TYPE MARKER TUBE P.42			0312 RELEASABLE MARKER TIE P.61						

CABLE TIES	CABLE TIES	CABLE TIES	WRAPPING BAND	CABLE CLAMPS	CABLE CLAMPS	CABLE CLAMPS
0312 MARKER TIE  P.61	0320 DOUBLE LOCKING CABLE TIE  P.68	0350 MAGIC CABLE TIE  P.74	0401 SPIRAL WRAPPING BAND  P.82	0501 CABLE CLAMP  P.88	0518 CABLE CLAMP  P.93	0530 FLAT CABLE CLAMP  P.98
0313 SECURITY MARKER TIE  P.62	0321 IN-LINE CABLE TIE  P.69	0350 MAGIC CABLE TIE  P.74	0401 SPIRAL WRAPPING BAND  P.82	0502 ADJUSTABLE CABLE CLAMP  P.88	0519 ADJUSTABLE CABLE CLAMP  P.94	0531 CABLE CLAMP  P.98
0314 MARKER TIE  P.62	0321 IN-LINE CABLE TIE  P.69	0355 NYLON CABLE TIE WITH STOPPER  P.75	0401 SPIRAL WRAPPING BAND  P.82	0503 CABLE CLAMP  P.88	0520 SELF-ADHESIVE WIRE CLIP  P.94	0532 CABLE CLAMP  P.99
0315 EASY RELEASABLE CABLE TIE  P.62	0325 KNOT TIE (BEAD TYPE)  P.69	0361 COATED COPPER TUBE CABLE TIE  P.75	0401 SPIRAL WRAPPING BAND  P.83	0505 SELF ADHESIVE TIE MOUNT  P.89	0520 SELF-ADHESIVE WIRE CLIP  P.95	0535 FLAT CABLE CLAMP  P.99
0315 RELEASABLE CABLE TIE  P.63	0326 DOUBLE HEAD KNOT TIE  P.70	0365 CABLE TIE WITH DECORATION TAG  P.76	0402 SPLIT WRAPPING BAND  P.83	0510 SADDLE TYPE TIE MOUNT  P.89	0521 MOUNTING WIRE CLIP  P.95	0539 CABLE CLAMP  P.100
0315 RELEASABLE CABLE TIE  P.63	0327 KNOT TIE  P.70	0365 CABLE TIE WITH 360 DEGREE ROTATION TAG  P.76	0403 SPLIT WRAPPING BAND INSTALLATION TOOL  P.83	0511 WALL PLUG MOUNT  P.90	0522 WIRE CLIP  P.95	0539 CABLE CLAMP  P.100
0315 RELEASABLE CABLE TIE  P.64	0330 WIRE COLLECT TIE  P.71	0365 HOOK TIE  P.77	0403 WRAPPING BAND  P.84	0511 WALL PLUG  P.90	0524 WIRE CLIP  P.96	0540 CABLE CLAMP  P.101
0315 RELEASABLE CABLE TIE  P.64	0332 WIRE COLLECT TIE  P.71	0365 LUGGAGE TIE  P.77	0403 WRAPPING BAND  P.84	0512 PUSH TIE MOUNT  P.91	0525 CATV SIDING CLIP  P.96	0545 SELF-ADHESIVE WIRE CLIP  P.101
0316 RELEASABLE LASHING CABLE TIE  P.65	0335 PUSH MOUNT TIE  P.72	0370 STAINLESS STEEL CABLE TIE  P.78	0405 BINDING BAND  P.85	0513 TWIN TIE DEVICE  P.91	0526 SELF-ADHESIVE WIRE CLIP  P.96	0550 PAPER ROLL CLIP  P.101
0318 PUSH MOUNT COLLECT TIE  P.65	0335 RELEASABLE PUSH MOUNT TIE  P.72	0371 STAINLESS STEEL TIE WITH COATING  P.79	0405 BINDING BAND  P.85	0514 LADDER TYPE CABLE HOLDER  P.92	0526 SELF-ADHESIVE WIRE CLIP  P.97	0555 SNAP CLAMP  P.102
0319 SADDLE MOUNTING TIE  P.66	0340 CABLE TRAY FIXING TIE  P.73	0372 LADDER TYPE STAINLESS STEEL TIE WITH COATING  P.79	0420 PVC VINYL TIE  P.85	0515 SELF-ADHESIVE CABLE CLAMP  P.92	0527 CABLE CLAMP  P.97	0558 PIPE CLIP  P.102
0320 DOUBLE LOCKING CABLE TIE  P.67	0342 CHASIS TIE  P.73	0373 STAINLESS STEEL TIE WITH COATING  P.80	0421 PET TIE  P.86	0517 PUSH TIE MOUNT  P.93	0528 CABLE CLAMP  P.97	
0320 DOUBLE LOCKING CABLE TIE  P.68	0343 MOUNTING ADJUSTABLE TIE  P.74	ALL SIZES ARE SUBJECT TO CHANGE WITHOUT PRIOR NOTICE	0425 SNAP BAND  P.86	0517 ADJUSTABLE CABLE CLAMP  P.93	0529 SELF-ADHESIVE WIRE CLIP  P.98	

BUSHINGS ↳ CONDUITS	BUSHINGS ↳ CONDUITS	BUSHINGS ↳ CONDUITS	BUSHINGS	BUSHINGS	WIRE CONNECTORS	TUBES
 0604 NYLON CABLE GLAND P.104	 0605 BUSHING GLAND P.113	 0616 EASY TYPE FLEXIBLE CONDUIT ADAPTOR P.130	 0701 MOVABLE BUSHING P.136	 0716 SCREW PLUG P.142	 0801 CLOSE-END WIRE CONNECTOR P.148	 0901 VINYL WIRE END CAP P.152
 0604 NYLON CABLE GLAND P.105	 0613 MULTI-HOLE NYLON CABLE GLAND (2-7 HOLES) P.114 ~ 123	 0620 NYLON FLEXIBLE CONDUIT P.130	 0701 MOVABLE BUSHING P.136	 0716 SCREW PLUG (PG) P.143	 0804 WIRE NUT DRIVE P.148	 0906 VINYL TUBE P.152
 0606 NYLON CABLE GLAND P.106	 0610 MICRO SWITCH COVER P.124	 0620 FLEXIBLE CONDUIT P.131	 0703 EDGING GROMMET P.137	 0721 EASY FIT GROMMET (OPEN/CLOSED) P.143	 0809 SCREW ON WIRE CONNECTOR P.149	 0905 VINYL WIRE END MARKER CAP P.153
 0606 NYLON CABLE GLAND P.107	 0611 NYLON LOCK NUT P.124	 0621 CONVEY FLEXIBLE CONDUIT P.131	 0705 STRAIN RELIEF BUSHING P.137	 0720 GROMMET (OPEN/CLOSED) P.144	 0809 SCREW ON WIRE CONNECTOR P.149	 0907 END CAP P.153
 0604 NYLON CABLE GLAND P.108	 0612 NYLON CABLE GLAND SEALING PLUG P.125	 0621 PVC FLEXIBLE CONDUIT P.132	 0705A STRAIN RELIEF BUSHING ASSEMBLY TOOL P.138	 0723 SQUARE HEAD GROMMET NUT P.144	 0810 MID-WAY WIRE CONNECTOR P.150	 0908 HEXAGONAL PROTECTION CAP P.153
 0608 NYLON CABLE GLAND P.109	 0614 WASHER P.125	 0617 METAL FLEXIBLE CONDUIT ADAPTOR P.132	 0707 SQUARE STRAIN RELIEF BUSHING P.138	 0725 D TYPE HOUSING COVER P.145	 0810 MID-WAY WIRE CONNECTOR P.150	 0908 SCREW PROTECTION CAP P.154
 0609 RIGHT ANGLE NYLON CABLE GLAND P.109	 0613 MULTI-HOLE SEAL P.126	 0625 METAL FLEXIBLE CONDUIT P.132	 0708 FLEXIBLE RIGHT ANGLE STRAIN RELIEF BUSHING P.138	 0727 ROUND TYPE HOUSING COVER P.145		 0909 SCREW PROTECTION CAP P.154
 0607 GLAND ADAPTOR P.110	 0613 FLAT-HOLE SEAL P.127	 0625 METAL FLEXIBLE CONDUIT ADAPTOR P.133	 0708 FLEXIBLE STRAIN RELIEF BUSHING P.139	 0730 USB HOUSING COVER P.145		 0910 ALLIGATOR CLIP P.155
 0607 ENLARGER GLAND P.110	 0615 FLEXIBLE CONDUIT ADAPTOR P.128	 0625 METAL FLEXIBLE CONDUIT ADAPTOR P.133	 0709 RIGHT ANGLE STRAIN RELIEF BUSHING P.139	 0730 USB HOUSING COVER P.146	<h1 style="font-size: 2em;">KSS</h1>	 0915 TUBE OF ALLIGATOR CLIP P.155
 0607 REDUCTION GLAND P.111	 0615 FLEXIBLE CONDUIT ADAPTOR P.128	 0625 METAL FLEXIBLE CONDUIT ADAPTOR P.133	 0710 SNAP BUSHING P.140	 0731 FUSE COVER P.146		YOUR WIRING MANAGEMENT
 0601 NYLON CABLE GLAND P.112	 0615 FLEXIBLE CONDUIT ADAPTOR P.128	 0625 METAL FLEXIBLE CONDUIT ADAPTOR P.134	 0712 SNAP BUSHING P.141	 0733 PLUG COVER P.146	ALL SIZES ARE SUBJECT TO CHANGE WITHOUT PRIOR NOTICE	 0927 HEAT-SHRINKABLE TUBINGS (K24) P.156
 0603 NYLON CABLE GLAND (WITH STRAIN RELIEF) P.112	 0616 EASY TYPE FLEXIBLE CONDUIT ADAPTOR P.129	 0625 METAL FLEXIBLE CONDUIT ADAPTOR P.134	 0713 SNAP BUSHING (OPEN/CLOSED) P.141	 0735 SCREW PLUG P.146		
 0602 NYLON CABLE GLAND (WITH STRAIN RELIEF) P.113	 0620 FLEXIBLE CONDUIT P.129	 0625 METAL FLEXIBLE CONDUIT END CAP P.134	 0715 HOLE PLUG P.142			 0927 HEAT-SHRINKABLE TUBINGS WITH INNER GLUE (SSA3) P.157

TUBES	CABLE CLIPS	CABLE CLIPS	PCB PARTS	PCB PARTS	PCB PARTS	PCB PARTS
0927 HEAT-SHRINKABLE TUBINGS WITH INNER GLUE P.158	1001 NAIL CABLE CLIP P.164	1022 DOUBLE NAIL CABLE CLIP P.171	1101 PCB SUPPORT P.174	1106 SCREW FASTENED PCB SUPPORT P.178	1114 HEXAGONAL SPACER P.183	1125 SNAP RIVET P.187
0927 HEAT-SHRINKABLE TUBINGS WITH INNER GLUE P.158	1001 NAIL CABLE CLIP P.164	1023 COATED COPPER TUBE CLIP P.172	1101 PCB SUPPORT P.174	1107 PUSH SPACER P.179	1115 PCB SUPPORT P.183	1126 SNAP RIVET P.188
0927 HEAT-SHRINKABLE TUBINGS (K32) P.159	1005 NAIL CABLE CLIP P.165	1030 PIN PLUG P.172	1101 PCB SUPPORT P.174	1108 PUSH SPACER P.179	1116 PCB SUPPORT P.183	1127 SCREW ON RIVET P.188
0927 HALOGEN FREE HEAT-SHRINKABLE TUBINGS (NHR2) P.160	1010 NAIL CABLE CLIP P.165		1102 PCB SUPPORT P.175	1108 PCB EDGE SPACER P.179	1117 PCB SUPPORT P.184	1128 PUSH RIVET P.189
0927 HALOGEN FREE HEAT-SHRINKABLE TUBINGS (NHR4) P.160	1011 NAIL CABLE CLIP P.166		1102 PCB SUPPORT P.175	1109 PCB SUPPORT P.180	1118 PCB SUPPORT P.184	1129 SNAP RIVET P.189
0931 PVC TUBE P.161	1010 NAIL CABLE CLIP P.166		1102 PCB SUPPORT P.176	1109 PCB SUPPORT P.180	1119 PCB SUPPORT P.184	1130 CANOE RIVET P.190
0933 HOT MELT ADHESIVE TUBE P.162	1011 NAIL CABLE CLIP P.167		1102 PCB SUPPORT P.176	1109 PCB SUPPORT P.180	1120 PCB SUPPORT P.185	1131 SNAP RIVET P.190
0933 HOT MELT ADHESIVE TUBE P.162	1020 NAIL CABLE CLIP P.168		1103 SCREW FASTENED PCB SUPPORT P.176	1109 PCB SUPPORT P.180	1120 PCB SUPPORT P.185	1132 DRIVE RIVET P.190
	1019 NAIL CABLE CLIP P.169		1103 SCREW FASTENED PCB SUPPORT P.176	1109 SELF-ADHESIVE PCB SUPPORT P.181	1121 PCB SUPPORT P.186	1136 DOOR LOCK P.191
	1018 NAIL CABLE CLIP P.169		1104 PCB SUPPORT P.177	1109 SELF-ADHESIVE PCB SUPPORT P.181	1121 PCB SUPPORT P.186	1140 ROUND SPACER P.191
	1020 NAIL CABLE CLIP P.170		1104 PCB SUPPORT P.177	1110 CIRCUIT BOARD TRACK P.181	1121 PCB SUPPORT P.186	1141 ROUND SPACER P.191
	1020 NAIL CABLE CLIP P.170		1105 CIRCUIT BOARD EJECTOR P.178	1111 HEXAGONAL THREADED SPACER P.182	1123 PCB SUPPORT P.187	1141 ROUND SPACER P.192
	1012 DOUBLE NAIL CABLE CLIP P.171		1106 BLIND HOLD PCB SUPPORT P.178	1113 HEXAGONAL TAPPED SPACER P.182	1125 SNAP RIVET P.187	1151 PCB HINGE P.192





FASTENERS	FASTENERS	FASTENERS	FASTENERS	FASTENERS	VALUE PACK	VALUE PACK	VALUE PACK
1201 WIRE SADDLE  P.194	1204 WIRE SADDLE  P.199	1303 TRANSISTOR HOUSING  P.204	1333 LED HOLDER  P.209	1401 PLASTIC SCREWS  P.215	 P.219	 P.223	 P.226
1201 WIRE SADDLE  P.194	1204 DOUBLE ROUTING CLIP  P.199	1305 WASHER  P.204	1334 LED HOLDER  P.209	1401 PLASTIC SCREWS  P.215	 P.219	 P.223	 P.226
1201 LOCKING WIRE SADDLE  P.194	1204 WIRE SADDLE  P.200	1306 WASHER  P.205	1335 LED HOLDER  P.210	1401 PLASTIC SCREWS  P.215	 P.219	 P.223	 P.227
1201 WIRE SADDLE  P.195	1204 CLIP TWIST TIE  P.200	1307 HEADBOARD WASHER  P.205	1336 LED HOLDER  P.210	2001 RJ45 MODULAR PLUG & PLUG COVER  P.216	 P.220	 P.223	 P.227
1201 WIRE SADDLE  P.195	1205 STANDOFF TWIST TIE  P.200	1308 ROUND WASHER  P.205	1337 LED HOLDER  P.210	2002 DUST COVER FOR RJ45 PLUG  P.216	 P.220	 P.224	 P.227
1202 LOCKING WIRE SADDLE  P.195	1209 WIRE SADDLE  P.201	1308 CONOID WASHER  P.206	1338 LED HOLDER  P.211	2005 U CONNECTOR  P.216	 P.220	 P.224	 P.227
1202 LOCKING WIRE SADDLE  P.196	1210 PURSE LOCK TWIST TIE  P.201	1310 TRANSISTOR WASHER  P.206	1339 LED HOLDER  P.211		 P.220	 P.224	 P.228
1202 LOCKING WIRE SADDLE  P.196	1212 TWIST TIE  P.201	1311 TRANSISTOR WASHER  P.206	1341 LED HOLDER  P.211		 P.221	 P.224	 P.228
1202 EDGING WIRE SADDLE  P.197	1215 MOUNTING TWIST TIE  P.202	1321 LED HOLDER  P.207	1343 LED HOLDER  P.212		 P.221	 P.224	 P.228
1202 EDGING WIRE SADDLE  P.197	1216 ADHESIVE WIRE SADDLE  P.202	1322 LED HOLDER  P.207	1344 LED HOLDER  P.212		 P.221	 P.224	 P.228
1202 EDGING WIRE SADDLE  P.197	1217 SPACERS RING  P.202	1327 LED HOLDER  P.207	1348 LED HOLDER  P.213		 P.221	 P.225	 P.228
1202 WIRE SADDLE  P.198	1301 TRANSISTOR HOUSING  P.203	1328 LED HOLDER  P.208	1346 LED HOLDER  P.213		 P.222	 P.225	 P.228
1203 N TYPE WIRE SADDLE  P.198	1301 TRANSISTOR HOUSING  P.203	1329 LED HOLDER  P.208	1347 LED HOLDER  P.214		 P.222	 P.225	 P.229
1204 WIRE SADDLE  P.198	1302 TRANSISTOR COVER  P.203	1331 LED HOLDER  P.208	1349 LED HOLDER  P.214	ALL SIZES ARE SUBJECT TO CHANGE WITHOUT PRIOR NOTICE	 P.222	 P.226	 P.229
1204 WIRE SADDLE  P.199	1302 NTC THERMISTOR HOUSING  P.204	1332 LED HOLDER  P.209	1351 CAPACITOR HOUSING  P.214		 P.222	 P.226	 P.229



Physical properties of pvc wiring ducts :

PROPERTY		TEST METHOD	RESULT
Mechanical Property	Impact Strength	ASTM D256	10kg-cm/cm ²
	Tensile Strength	ASTM D638	500kg/cm ²
Thermal Property	Heat Deflection Temperature	ASTM D648	65°C
	Softening Temperature	ASTM D1525	86°C
Flammability Property	Flammability	UL94	V-0

Safety Certification :

	Underwriters Laboratories, Inc
	Canadian Standards Association
	Conformity European
	VDE Prüf- und Zertifizierungsinstitut

WIRING DUCTS

0101 KSS WIRING DUCT (SLOTTED)



UNIT : mm

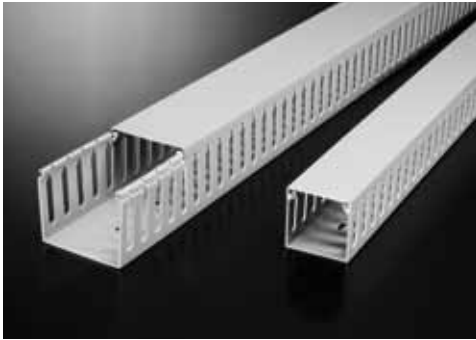

MD SLOT : 8mm

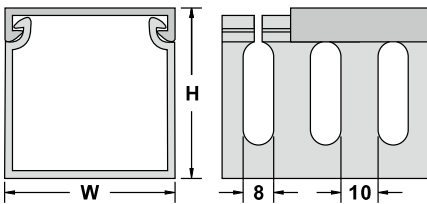

KD SLOT : 6mm

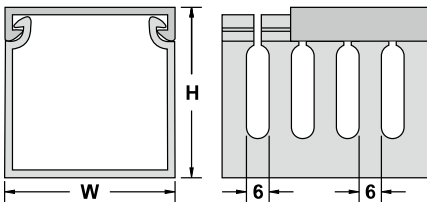

HD SLOT : 4mm

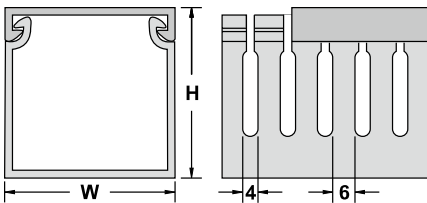

FIXING SLOT

For width :
25mm , 33mm , 40mm ,
45mm , 50mm , 60mm , 65mm

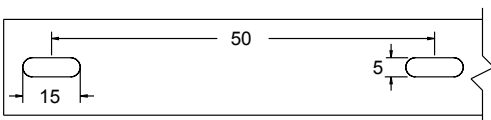

Item No.			W x H	Wires to be Contained (16-14 AWG)	Length
SLOT					
8mm	6mm	4mm			
MD-0.5L		HD-0.5L	15 X 25	5~12pcs	2M
MD-0.7L		HD-0.7L	20 X 20	5~12pcs	
MD-0L		HD-0L	25 X 25	10~25pcs	
MD-1L	KD-1L	HD-1L	25 X 45	20~25pcs	
MD-1.1L		HD-1.1L	30 X 30	15~25pcs	
MD-1.2L	KD-1.2L	HD-1.2L	33 X 33	25~45pcs	
MD-1.5L	KD-1.5L	HD-1.5L	33 X 45	40~55pcs	
MD-2L	KD-2L	HD-2L	45 X 45	60~70pcs	
MD-2.2L		HD-2.2L	50 X 50	80~90pcs	
MD-2.5L	KD-2.5L	HD-2.5L	65 X 45	110~120pcs	
MD-3L	KD-3L	HD-3L	33 X 65	60~75pcs	
MD-4L	KD-4L	HD-4L	25 X 65	40~45pcs	
MD-5L	KD-5L	HD-5L	45 X 65	110~120pcs	
MD-5.5L	KD-5.5L	HD-5.5L	60 X 60	120~135pcs	
MD-5.7L	KD-5.7L	HD-5.7L	65 X 65	180~200pcs	
MD-6L			72 X 64	200~220pcs	
MD-6.5L		HD-6.5L	33 X 100	180~200pcs	
MD-6.6L			37.5 X 100	180~200pcs	
MD-6.7L	KD-6.7L	HD-6.7L	48 X 100	215~250pcs	
MD-6.8L			55 X 100	220~260pcs	
MD-6.9L			75 X 75	200~250pcs	
MD-7L			70 X 100	250~300pcs	
MD-7.1L			75 X 100	260~320pcs	
MD-7.2L			100 X 50	200~250pcs	
MD-7.5L			100 X 75	260~320pcs	
MD-8L	KD-8L	HD-8L	100 X 100	300~400pcs	
MD-9L			120 X 75	280~380pcs	
MD-10L			150 X 75	335~500pcs	
MD-12L			150 X 100	450~600pcs	
MD-15L			200 X 100	600~800pcs	
MD-21L			200 X 150	1040~1200pcs	
MD-22L			200 X 200	1200~1600pcs	
MD-30L			300 X 100	1040~1200pcs	

- Material: Warp proof self-extinguishing UL approved PVC, 94V-0 flammability rating, M1 rating NF fire resistant test.
- Color: Grey.
- Vicat softening point: 86°C
- UL Test up to 50°C
- These devices are for routing of wires within devices in factory installations.
- Features parallel holes on both sidewalls to facilitate cutting in wire application.
- Special color, size, length upon request of reasonable quantity.
- ※ The standard wiring duct can be available for non-slip cover, suitable for vertical installations. The item number please specify for example, Item no. : MD-2▶MQ-2, KD-5.5▶KQ-5.5, HD-8▶HQ-8
- Non-slip cover for the size less than 20mm width or bigger than 125mm is available upon request.
- ※ Item number with suffix-V for upper score line allows finger removal without tool during the installation when a greater opening is required. For example: MDV-2L

0101 KSS WIRING DUCT (SLOTTED)

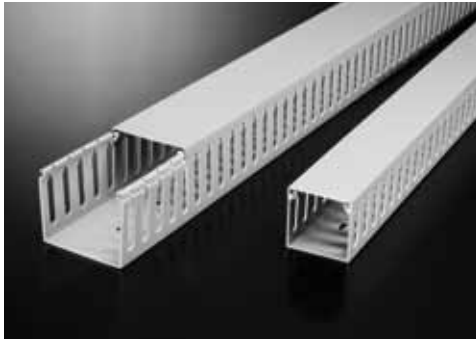
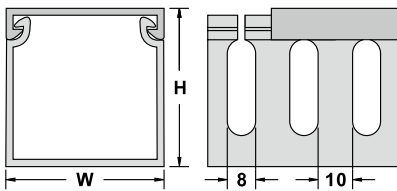
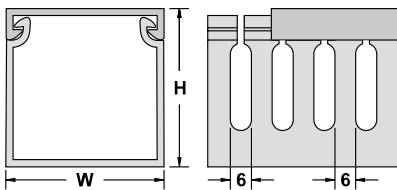
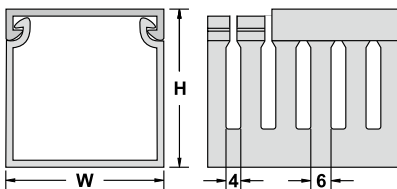

UNIT : mm

VD SLOT : 8mm

KVD SLOT : 6mm

HVD SLOT : 4mm

Item No.			W x H	Wires to be Contained (16-14 AWG)	Length
SLOT					
8mm	6mm	4mm			
VD-1		HVD-1	25 X 30	15~25pcs	2M
VD-1.5		HVD-1.5	30 X 30	15~25pcs	
VD-2		HVD-2	25 X 40	20~25pcs	
VD-3		HVD-3	33 X 40	40~45pcs	
VD-4	KVD-4	HVD-4	40 X 40	60~70pcs	
VD-5		HVD-5	60 X 40	100~115pcs	
VD-5.5		HVD-5.5	80 X 40	120~135pcs	
VD-5.7		HVD-5.7	100 X 40	130~175pcs	
VD-6		HVD-6	25 X 60	40~45pcs	
VD-7	KVD-7	HVD-7	40 X 60	100~115pcs	
VD-8	KVD-8	HVD-8	60 X 60	120~135pcs	
VD-9		HVD-9	80 X 60	180~210pcs	
VD-9.5		HVD-9.5	100 X 60	240~290pcs	
VD-9.6		HVD-9.6	120 X 60	240~290pcs	
VD-9.65		HVD-9.65	120 X 65	260~360pcs	
VD-9.66		HVD-9.66	25 X 80	100~120pcs	
VD-9.7		HVD-9.7	40 X 80	120~135pcs	
VD-9.8		HVD-9.8	60 X 80	180~210pcs	
VD-10		HVD-10	80 X 80	240~290pcs	
VD-10.5		HVD-10.5	100 X 80	260~350pcs	
VD-11		HVD-11	120 X 80	300~400pcs	
VD-12		HVD-12	40 X 100	130~175pcs	
VD-13		HVD-13	60 X 100	240~290pcs	
VD-14		HVD-14	80 X 100	260~350pcs	

- Material: Warp proof self-extinguishing UL approved PVC, 94V-0 flammability rating, M1 rating NF fire resistant test.
- Color: Grey.
- Vicat softening point: 86°C
- UL Test up to 50°C
- These devices are for routing of wires within devices in factory installations.
- Features parallel holes on both sidewalls to facilitate cutting in wire application.

※The standard wiring duct can be available for non-slip cover, suitable for vertical installations. The item number please specify for example,

Item no. : VD-8→VQ-8, KVD-8→KVQ-8, HVD-8→HVQ-8

Non-slip cover for the size less than 20mm width or bigger than 125mm is available upon request.

0101A KSS WIRING DUCT CUTTER

Item No. : WT-1



Item No. : WT-2

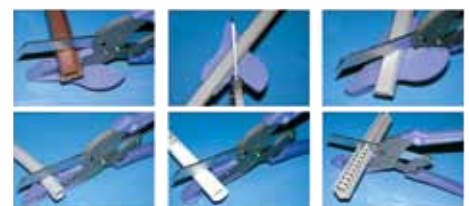

0101 KSS WIRING DUCT (CLOSE SLOTTED)



UNIT : mm

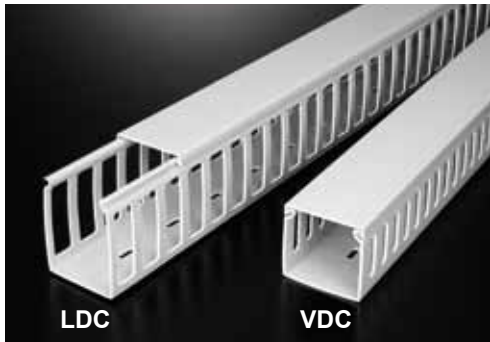

VDC SLOT : 8mm

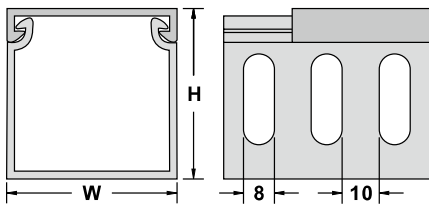

LDC SLOT : 17mm

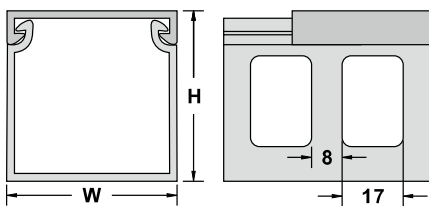

Item No.		W x H	Wires to be Contained (16-14 AWG)	Length
SLOT				
8mm	17mm			
VDC-2530		25 X 30	15~25pcs	2M
VDC-4040		40 X 40	60~70pcs	
VDC-8040		80 X 40	120~135pcs	
VDC-5050		50 X 50	80~90pcs	
VDC-2560		25 X 60	40~45pcs	
VDC-4060	LDC-4060	40 X 60	100~115pcs	
VDC-6060	LDC-6060	60 X 60	120~135pcs	
VDC-8060	LDC-8060	80 X 60	180~210pcs	
	LDC-3365	33 X 65	60~75pcs	
	LDC-4565	45 X 65	110~120pcs	
	LDC-6565	65 X 65	180~200pcs	
VDC-4080	LDC-4080	40 X 80	120~135pcs	
VDC-6080	LDC-6080	60 X 80	180~210pcs	
VDC-8080	LDC-8080	80 X 80	240~290pcs	
	LDC-33100	33 X 100	180~200pcs	
VDC-40100		40 X 100	130~175pcs	
	LDC-48100	48 X 100	215~250pcs	
VDC-100100	LDC-100100	100 X 100	300~400pcs	

- Material: Warp proof self-extinguishing UL approved PVC, **94V-0** flammability rating, M1 rating NF fire resistant test.
 - Color: Grey.
 - Vicat softening point: 86°C
 - Close slot design facilitate easy installation or removal of cover.
 - LDC series with larger slot is suitable for big wire, and vaporize the heat from cables much quickly.
 - Slot can be cut when enlarge slot is necessary.
- ※The standard wiring duct can be available for non-slip cover, suitable for vertical installations. The item number please specify for example, Item no. : VDC-2530→VQC-2530
 Non-slip cover for the size less than 20mm width or bigger than 125mm is available upon request.

0101 KSS NON-SLIP WIRING DUCT COVER

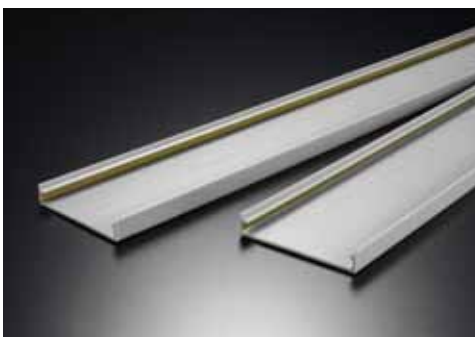

Item No.					Length
DCQ-20L	DCQ-40L	DCQ-60L	DCQ-75L	DCQ-125L	2M
DCQ-25L	DCQ-45L	DCQ-65L	DCQ-80L		
DCQ-30L	DCQ-50L	DCQ-70L	DCQ-100L		
DCQ-33L	DCQ-55L	DCQ-72L	DCQ-120L		

- Material: Warp proof self-extinguishing UL approved PVC, **94V-0** flammability rating, M1 rating NF fire resistant test and PE copolymer.
- Color: Grey.
- Feature: Neat and stable gluey layer inside duct cover tightens the base and cover more firmly. Cover won't slide easily and stays in place for vertical orientation. Installation will be convenient and safe.

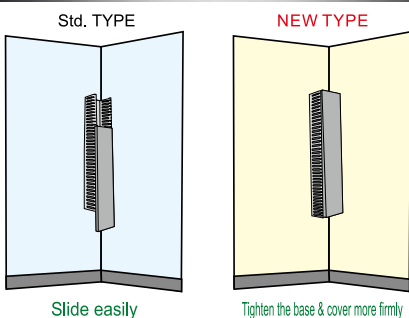

0101 KSS WIRING DUCT (SLOTTED)

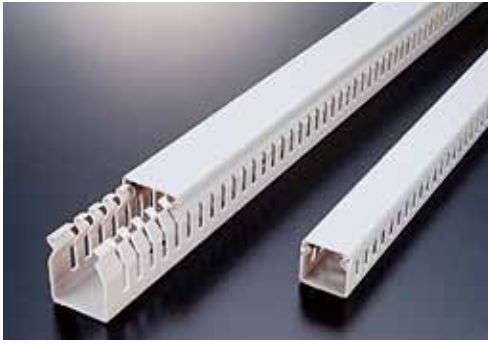
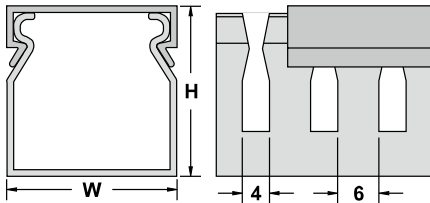

UNIT : mm

BD
SLOT : 4mm

Item No.	W x H	Wires to be Contained (16-14 AWG)	Length
SLOT			
BD-2525	25 X 25	10~25pcs	2M
BD-3340	33 X 40	40~45pcs	
BD-4040	40 X 40	50~60pcs	
BD-3360	33 X 60	60~70pcs	
BD-4860	48 X 60	110~120pcs	
BD-6060	60 X 60	120~135pcs	

- Material: Warp proof self-extinguishing UL approved PVC, **94V-0** flammability rating, M1 rating NF fire resistant test.
- Color: Grey.
- Vicat softening point: 86°C
- UL Test up to 50°C
- These devices are for routing of wires within devices in factory installations.
- Features parallel holes on both sidewalls to facilitate cutting in wire application.

0101 KSS WIRING DUCT (SLOTTED)



UNIT : mm

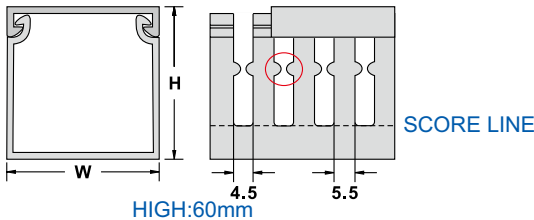

Item No.	W x H	Wires to be Contained (16-14 AWG)	Length
SLOT			
GD-3060	30 X 60	30~50pcs	2M
GD-4060	40 X 60	100~115pcs	
GD-6060	60 X 60	110~120pcs	
GD-8060	80 X 60	180~210pcs	
GD-10060	100 X 60	240~290pcs	
GD-12060	120 X 60	240~290pcs	
GD-3080	30 X 80	110~115pcs	
GD-4080	40 X 80	120~135pcs	
GD-6080	60 X 80	180~210pcs	
GD-8080	80 X 80	240~290pcs	
GD-10080	100 X 80	260~350pcs	
GD-12080	120 X 80	300~400pcs	

- Material: Warp proof self-extinguishing UL approved PVC, **94V-0** flammability rating, M1 rating NF fire resistant test.
 - Color: Grey.
 - Vicat softening point: 86°C
 - UL Test up to 50°C
 - 4.5mm SLOT with score line.
- ※ The standard wiring duct can be available for non-slip cover, suitable for vertical installations. The item number please specify for example, Item no. : GD-3060→GQ-3060
- Non-slip cover for the size less than 20mm width or bigger than 125mm is available upon request.

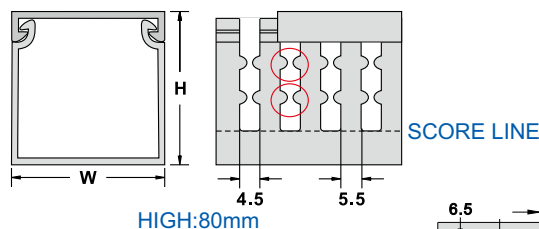
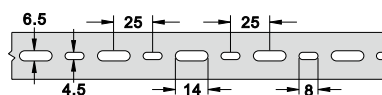
BASE HOLE SIZE

Width:30~60mm

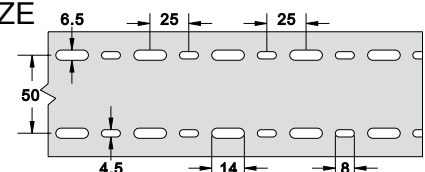

Width:80~120mm

0101 KSS WIRING DUCT (SLOTTED)



UNIT : mm



MPD SLOT : 8mm

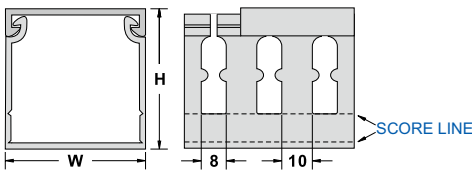

PD SLOT : 5mm

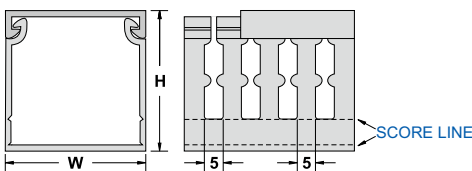

MID SLOT : 8mm

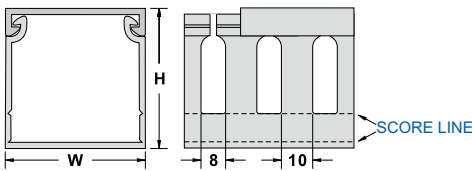

HID SLOT : 4mm

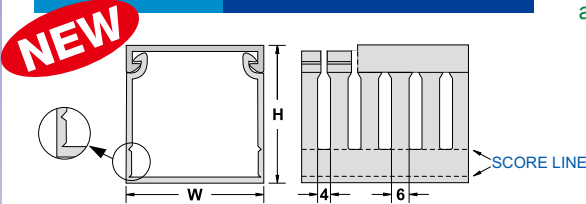

Item No.				W x H	Wires to be Contained (16-14 AWG)	Length
SLOT						
8mm	5mm	8mm	4mm			
		MID-2530		25 X 30	15~25pcs	2M
		MID-2540		25 X 40	20~25pcs	
MPD-2550	PD-2550			25 X 50	20~25pcs	
		NEW HID-2560		25 X 60	40~45pcs	
MPD-2575	PD-2575			25 X 75	60~75pcs	
		NEW HID-2580		25 X 80	60~75pcs	
		NEW HID-4080		40 X 80	120~135pcs	
MPD-5050	PD-5050			50 X 50	80~90pcs	
MPD-5075	PD-5075			50 X 75	180~200pcs	
		NEW HID-6080		60 X 80	180~210pcs	
MPD-7575	PD-7575			75 X 75	200~250pcs	
MPD-100100	PD-100100			100 X 100	300~400pcs	

- Material: Warp proof self-extinguishing UL approved PVC, 94V-0 flammability rating, M1 rating NF fire resistant test.
 - Color: Grey.
 - Vicat softening point: 86°C
 - UL Test up to 50°C
 - Double Score lines: The restricted slot, sidewall design is scored at the base of each finger and the base of duct. It is easy for the user to break finger from the base to enlarge bundle of wire.
 - Pinch Points: To separate the wires from top and bottom to avoid the wires tangled.
 - Narrow and Larger Fingers: Both are available to supply the installer for different application.
 - Outward sidewall design: Provide the resistance to prevent the cover/lid slipping off.
- ※ The standard wiring duct can be available for non-slip cover, suitable for vertical installations. The item number please specify for example,
 Item no. : MPD-2550→MPQ-2550, PD-2550→PQ-2550,
 MID-2530→MIQ-2530, HID-2560→HIQ-2560
- Non-slip cover for the size less than 20mm width or bigger than 125mm is available upon request.

0104 KSS FLEXIBLE WIRING DUCT



UNIT : mm



Item No.	W	H	Wires to be Contained (16-14 AWG)	Length
FD-20	20.4	14.4	5~12 pcs	50cm
FD-30	29.0	24.9	12~30 pcs	

- Material: UL approved Nylon 66 94V-2
- Color: Grey.
- Feature: connector design at both end, Ducts can conjoint each other.

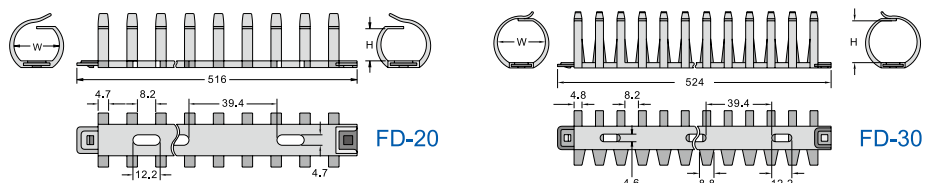

0101 KSS WIRING DUCT (SLOTTED)



UNIT : mm

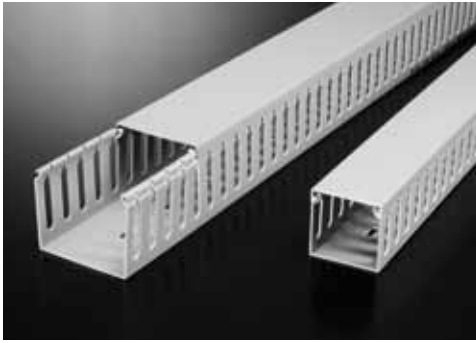

AD SLOT : 8mm

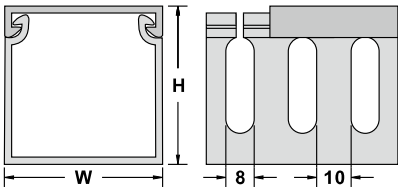

HD SLOT : 4mm

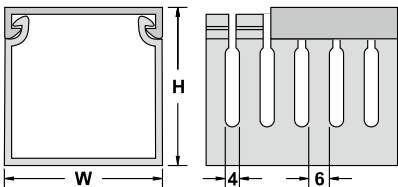

SD SOLID

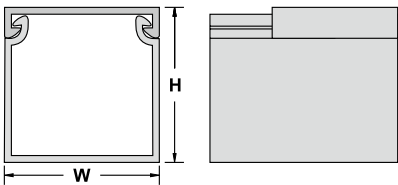

Item No.			W x H	Wires to be Contained (16-14 AWG)	Length
SLOT		SOLID			
8mm	5mm				
AD-1.5 X 1		SD-1.5 X 1	38 X 25	20~23pcs	2M
AD-2 X 1	HD-2 X 1	SD-2 X 1	50 X 25	25~45pcs	
AD-2 X 2		SD-2 X 2	50 X 50	80~90pcs	
AD-2 X 3	HD-2 X 3	SD-2 X 3	50 X 75	180~200pcs	
AD-3 X 2	HD-3 X 2	SD-3 X 2	75 X 50	180~200pcs	
AD-3 X 3	HD-3 X 3	SD-3 X 3	75 X 75	200~250pcs	
AD-3 X 4		SD-3 X 4	75 X 100	240~300pcs	

- Material: Warp proof self-extinguishing UL approved PVC, 94V-0 flammability rating, M1 rating NF fire resistant test.
- Color: Grey.
- Vicat softening point: 86°C
- UL Test up to 50°C
- These devices are for routing of wires within devices in factory installations.
- Features parallel holes on both sidewalls to facilitate cutting in wire application.

※ The standard wiring duct can be available for non-slip cover, suitable for vertical installations. The item number please specify for example, Item no. : AD-1X2→AQ-1X2, HD-1X2→HQ-1X2, SD-1.5X1→SQ-1.5X1
Non-slip cover for the size less than 20mm width or bigger than 125mm is available upon request.

0105 KSS MINI TRUNKING



UNIT : mm

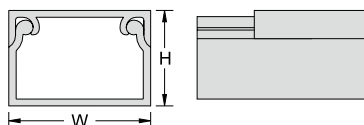
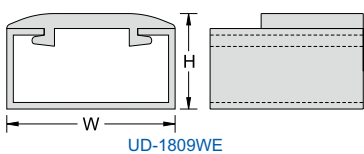

UD-1616WE, UD-2516WE, UD-4016WE, UD-4025WE, UD-5025WE

Item No.	W x H	Wires to be Contained (16-14 AWG)	Length
UD-1809WE	18 X 10.2	2~6 pcs	2M
UD-1616WE	16 X 16	3~10 pcs	
UD-2516WE	25 X 16	5~12 pcs	
UD-4016WE	40 X 16	20~35 pcs	
UD-4025WE	40 X 25	20~40 pcs	
UD-5025WE	50 X 25	25~45 pcs	

- Material: Warp proof self-extinguishing UL approved PVC, 94V-0 flammability rating, M1 rating NF fire resistant test.
- Color : White.
- Vicat softening point: 86°C
- Solid type can protect wire from external damage such like dust or mouse.

0105 KSS WIRING DUCT (SOLID)

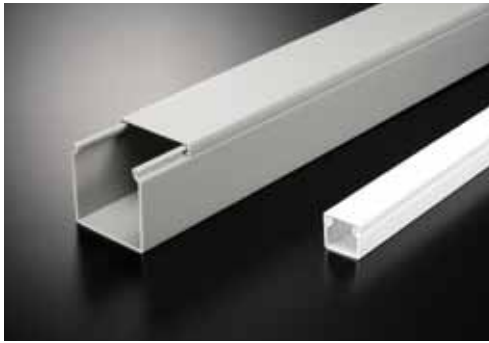

SOLID: No slot design, for external wiring or where wire extraction is not necessary.

- Material: Warp proof self-extinguishing UL approved PVC, 94V-0 flammability rating, M1 rating NF fire resistant test.
- Color: Grey.
- Vicat softening point: 86°C
- UL Test up to 50°C
- These devices are for routing of wires within devices in factory installations.
- Solid type can protect wire from external damage such dust or mouse.
- Special color, size, length upon request at reasonable quantity.

※The standard wiring duct can be available for non-slip cover, suitable for vertical installations. The item number please specify for example,

Item no. : SD-2525▶SQ-2525

Non-slip cover for the size less than 20mm width or bigger than 125mm is available upon request.

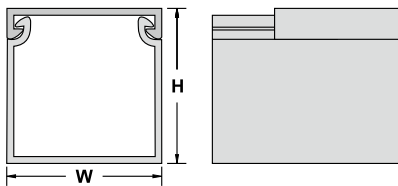

UNIT : mm

Item No.	W x H	Wires to be Contained (16-14 AWG)	Length
SD-1616	16 X 16	3~10pcs	2M
SD-2516	25 X 16	5~12pcs	
SD-3816	38 X 16	12~30pcs	
SD-2020	20 X 20	5~12pcs	
SD-4020	40 X 20	20~40pcs	
SD-1525	15 X 25	5~12pcs	
SD-2525	25 X 25	10~25pcs	
SD-3825	38 X 25	20~40pcs	
SD-5025	50 X 25	25~45pcs	
SD-3333	33 X 33	25~45pcs	
SD-3340	33 X 40	40~45pcs	
SD-4040	40 X 40	60~70pcs	
SD-6040	60 X 40	100~115pcs	
SD-7540	75 X 40	120~135pcs	
SD-8040	80 X 40	120~135pcs	
SD-10040	100 X 40	130~175pcs	
SD-3345	33 X 45	40~55pcs	
SD-4545	45 X 45	60~70pcs	
SD-6545	65 X 45	110~120pcs	
SD-5050	50 X 50	80~90pcs	

Item No.	W x H	Wires to be Contained (16-14 AWG)	Length
SD-7550	75 X 50	180~200pcs	2M
SD-10050	100 X 50	200~260pcs	
SD-4060	40 X 60	100~115pcs	
SD-6060	60 X 60	120~135pcs	
SD-8060	80 X 60	180~210pcs	
SD-10060	100 X 60	240~290pcs	
SD-4565	45 X 65	110~120pcs	
SD-6565	65 X 65	180~200pcs	
SD-5075	50 X 75	180~200pcs	
SD-7575	75 X 75	200~250pcs	
SD-10075	100 X 75	260~320pcs	
SD-15075	150 X 75	335~500pcs	
SD-4080	40 X 80	120~135pcs	
SD-6080	60 X 80	180~210pcs	
SD-8080	80 X 80	240~290pcs	
SD-80100	80 X 100	260~350pcs	
SD-100100	100 X 100	300~400pcs	
SD-150100	150 X 100	450~600pcs	
SD-200100	200 X 100	600~800pcs	
SD-300100	300 X 100	1040~1200pcs	

▲ Other types of wiring duct can be customized.

0105 KSS WIRING DUCT CONNECTOR



UNIT : mm

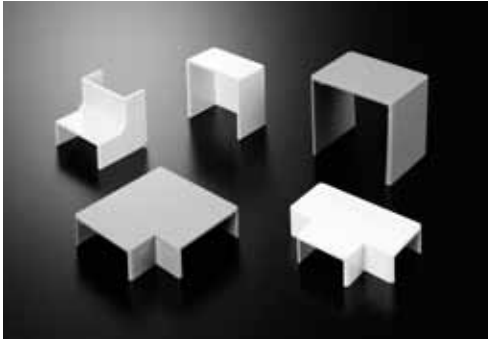

- Material: UL approved ABS, 94HB
- Function: Apply with SD type wiring duct to connect ducts easy and neatly.

Connectors	Type	Item No.	Used With	Packing
	MID-WAY CONNECTOR	SDM-1616	SD-1616	20 pcs
		SDM-2516	SD-2516	
		SDM-3816	SD-3816	
		SDM-4040	SD-4040	
		SDM-5050	SD-5050	
		SDM-7575	SD-7575	
	"T" TYPE	SDT-1616	SD-1616	
		SDT-2516	SD-2516	
		SDT-3816	SD-3816	
		SDT-4040	SD-4040	
		SDT-5050	SD-5050	
		SDT-7575	SD-7575	
	INSIDE CORNER	SDI-1616	SD-1616	
		SDI-2210D	SD-2210	
		SDI-2516	SD-2516	
		SDI-3816	SD-3816	
		SDI-4040	SD-4040	
		SDI-5050	SD-5050	
		SDI-7575	SD-7575	

Connectors	Type	Item No.	Used With	Packing
	OUTSIDE CORNER	SDO-1616	SD-1616	20 pcs
		SDO-2516	SD-2516	
		SDO-3816	SD-3816	
		SDO-4040	SD-4040	
		SDO-5050	SD-5050	
		SDO-7575	SD-7575	
	"L" TYPE	SDL-1616	SD-1616	
		SDL-2516	SD-2516	
		SDL-3816	SD-3816	
		SDL-4040	SD-4040	
		SDL-5050	SD-5050	
		SDL-7575	SD-7575	
	END PIECE	SDE-1616	SD-1616	
		SDE-2210	SD-2210	
		SDE-2516	SD-2516	
		SDE-3816	SD-3816	
		SDE-4040	SD-4040	
		SDE-5050	SD-5050	
		SDE-7575	SD-7575	

0105 KSS WIRING DUCT



UNIT : mm

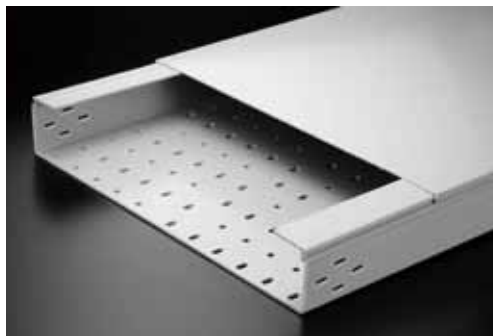

Item No.	W x H	Wires to be Contained (16-14 AWG)	Length
NEW SDH-15060	150 X 60	310~480pcs	2M <small>(3M available upon request)</small>
NEW SDH-150100	150 X 100	450~600pcs	
NEW SDH-200100	200 X 100	600~800pcs	
SDH-300100	300 X 100	1040~1200pcs	2M <small>(3M available upon request)</small>
SDH-300100J	300 X 100	1040~1200pcs	
SDH-400100	400 X 100	1380~1600pcs	
SDH-500100J	500 X 100	1730~2000pcs	
SDH-600100	600 X 100	2080~2400pcs	

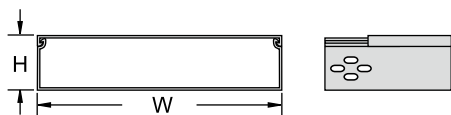

SDH-15060, 150100, 200100, 300100

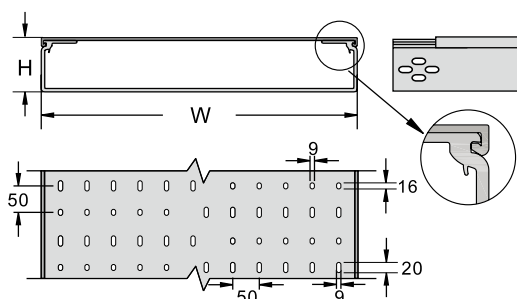

SDH-300100J, 400100, 500100J, 600100

- Material: Warp proof self-extinguishing UL approved PVC, 94V-0 flammability rating, M1 rating NF fire resistant test.
- Color: Grey.
- Vicat softening point: 86°C
- Feature: Special designed hook and slot base, makes installation easier and faster. Apply with L type coupler to connect wiring ducts easily.
- Fixing slot on duct base designs to help cooling cable faster.
- ※ SDH-15060, SDH-150100, SDH-200100 please reference the structure design of P.16

0105 KSS WIRING DUCT



UNIT : mm

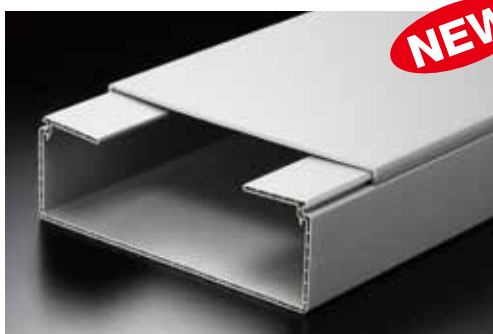

Item No.	W x H	Wires to be Contained (16-14 AWG)	Length
ZD-300100	300 X 100	1040~1200pcs	2M <small>(3M available upon request)</small>

- Material: Warp proof self-extinguishing UL approved PVC, 94V-0 flammability rating, M1 rating NF fire resistant test.
- Color: Grey.
- Vicat softening point: 86°C
- Feature: light weight, hollow wall design.

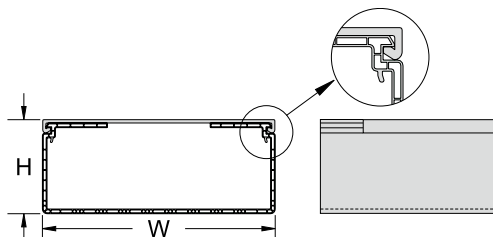

0105 KSS WIRING DUCT CONNECTOR

<p>(A) Base Without Fixing Hole (2M)</p> <p>SDB</p>	<p>(B) Base With Fixing Hole (2M)</p> <p>SDHB</p>	<p>(C) Downward Connector (duct cover)</p> <p>45° 90°</p> <p>SDHA SDHO</p>	<p>(D) Upward Connector (duct cover)</p> <p>45° 90°</p> <p>SDHV SDHI</p>
<p>(E) Connector "L" TYPE (duct cover)</p> <p>90° 45°</p> <p>SDHL SDHF</p>	<p>(F) Connector "T" TYPE (duct cover)</p> <p>SDHT</p>	<p>(G) Connector "X" TYPE (duct cover)</p> <p>SDHX</p>	<p>(H) Cover (2M)</p> <p>DC</p>
<p>(I) END PIECE</p> <p>SDE</p>	<p>(J) T Type Connector Parts</p> <p>DCPT1</p>	<p>(K) Reinforce Connector</p> <p>DCP-100A</p>	<p>(L) Reinforce Connector & Separator</p> <p>DCP-100</p>
<p>(M) Angle Adjuster</p> <p>DCI-100</p>	<p>(N) Angle Adjuster</p> <p>DCI-60</p>	<p>Other types of wiring duct can be customized. Connectors (C)(D)(E)(F)(G) includes cover and base. To order base only add a "B" after the model number. Example: For wiring Duct model no. SDH-400100, full set downward connector no. is SDHA-400100, base model no. is SDHAB-400100, cover model no. is DCA-400100. Connecting wiring duct and connector require 2 couplers. To fix a single coupler requires 6 screws and nuts.</p>	

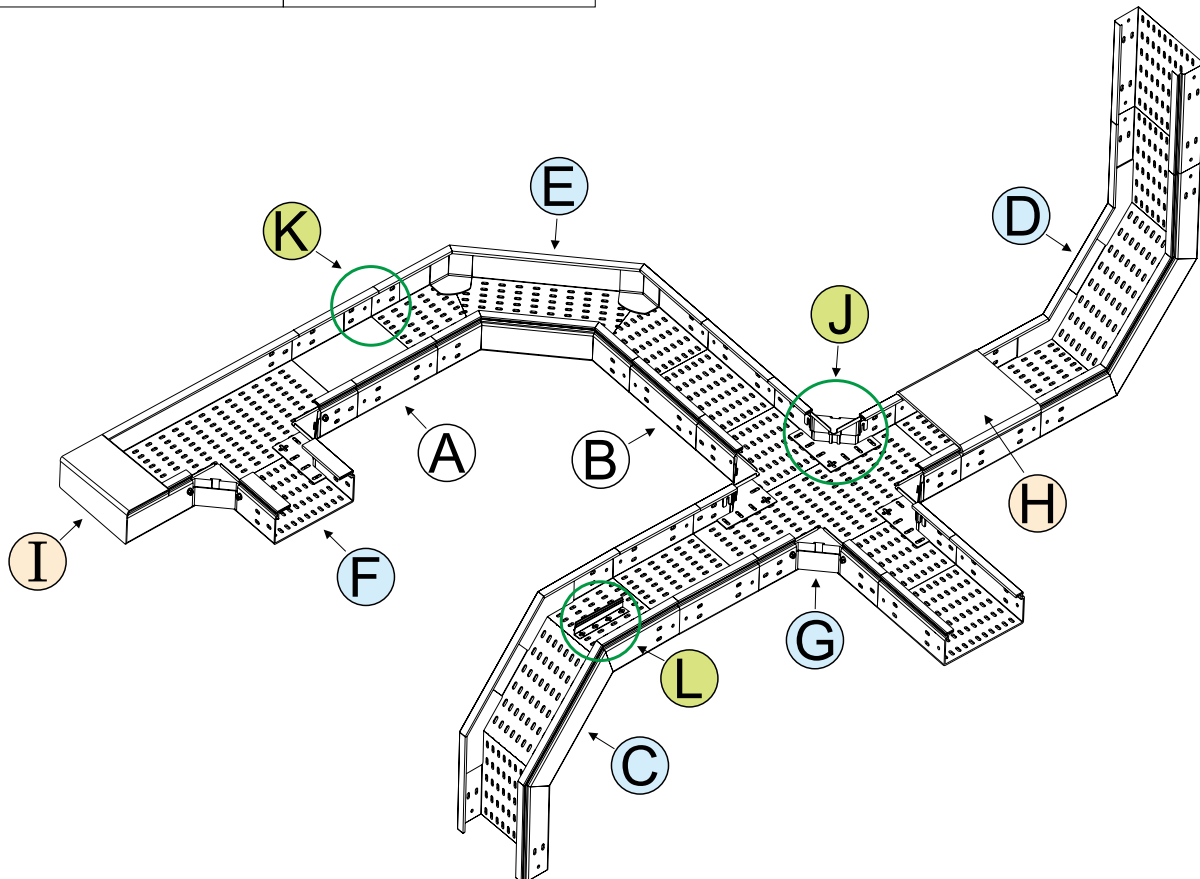

0105 KSS WIRING DUCT COUPLER



UNIT : mm

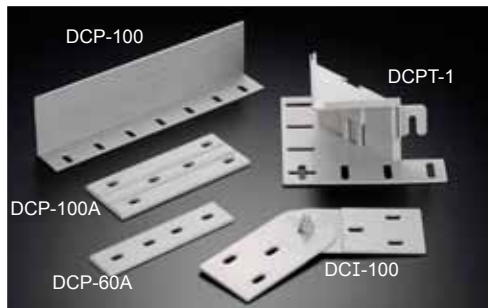

(Refer to P.215)

Item No.	B	Length	Used With SDH duct Height	Packing
▲ DCP-100	75.5	350	100 mm	1pcs
DCP-60A	43.0	170	60 mm	
DCP-100A	75.0	184.6	100 mm	
DCI-60	43.0	130	60 mm	1 set (with 2pcs & screw as picture)
DCI-100	75.0	160	100 mm	
DCPT-1	58.5	190	100 mm	1 set (with top & bottom as picture)

- Material: UL approved ABS, 94HB
- Color: Grey.
- Application: 1. DCP-100, DCP-60A, DCP-100A: apply 1 coupler on each side and fix with 6 screw and nuts. DCP-100 also functions as divider plate.
- 2. DCI-60, DCI-100: 1set includes 2 couplers and screws. Apply 2 couplers each side and fix with 6 screws and nuts to adjust angle.
- 3. DCPT-1: 1 set includes cover and base. To connect wiring duct at 90 degree needs to apply 1 set each side.
- ▲ DCP-100 UL recognized PVC material with flammability rating of M1 and 94V-0 for vicat softening temperature of 86°C.
- ※ Applied with screw PF-823HNGYJ and nut PN-8HNGYJ

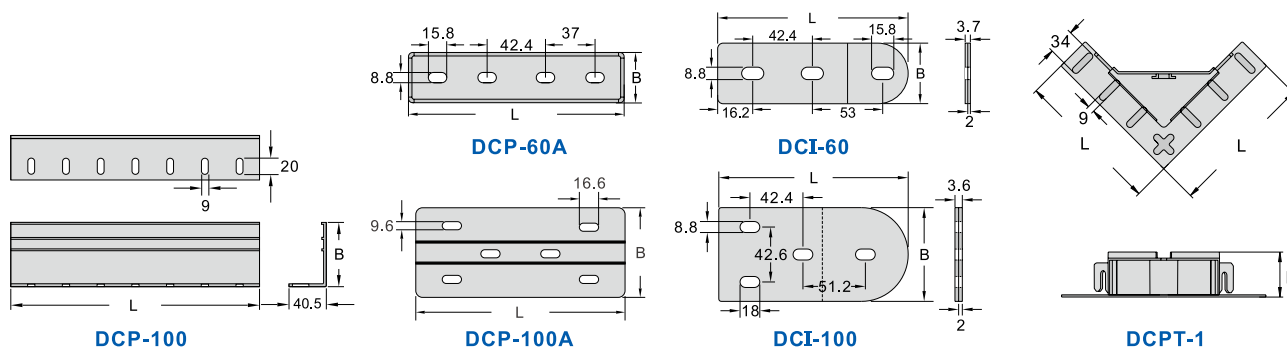

0106 KSS WIRING RETAINER



UNIT : mm



Item No.	W x H	Packing
LS-2040	20 X 40	100pcs With Adhesive Tape
LS-4040	40 X 40	
LS-7040	70 X 40	
LS-2065	20 X 65	
LS-4065	40 X 65	
LS-6565	65 X 65	

- Material: UL approved ABS, 94HB
- Color: Grey.
- Fix wire saddle by screw first and put wires inside.
- To make wires in good order and neatly.

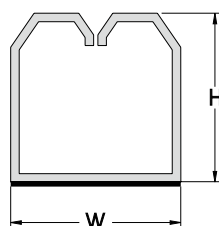

0106 KSS WIRE SADDLE



UNIT : mm



Item No.	W x H	Packing
LS-4267	42 X 69	50pcs

- Material: UL approved ABS, 94HB
- Color: Black.
- Fix wire saddle by screw first and put wires inside.
- To make wires in good order and neatly.

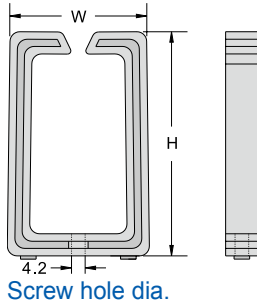

1125 KSS SNAP RIVET



UNIT : mm



Item No.	A	B	Panel thickness	Packing
SR-0612K	6.2	12.3	7.0-10.0	1000pcs
SR-0815K	8.0	14.0	7.0-12.0	

- Material: UL approved Nylon 66 94V-2
- Color: Black
- Feature: substitute for metal screw, with great insulating property.

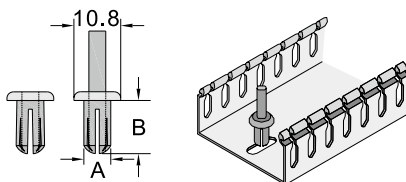

0107 KSS WIRING DUCT



UNIT : mm



Item No.	W	H	W1	W2	W3	Length
WD-2010-2WE	20.0	10.3	7.5	7.5		2M
WD-3010-2WE	30.0	11.2	12.5	12.5		
WD-4010-3WE	40.0	10.3	11.0	11.5	11.5	
WD-5020-3WE	50.8	20.3	14.8	10.0	14.8	
WD-10040-3WE	100.0	40.0	32.8	23.2	32.8	
※ WD-11060WE	111.0	61.4	43.3	16.0	43.3	

- Material: Warp proof self-extinguishing UL approved PVC, 94V-0 flammability rating, M1 rating NF fire resistant test.
- Color: White
- Vicat softening point: 86°C
- Feature: with divider wall to easy categorize different cables.
- ※ WD-11060WE without divider wall

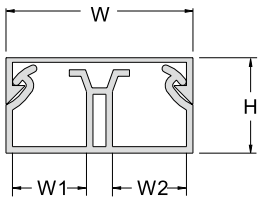

WD-2010-2WE
WD-3010-2WE

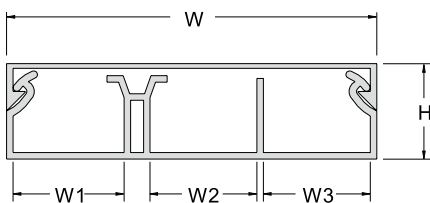

WD-4010-3WE

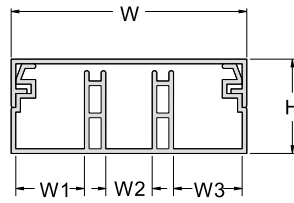

WD-5020-3WE

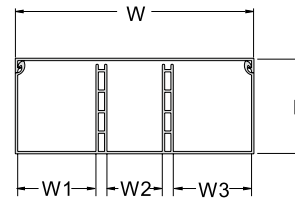

WD-10040-3WE

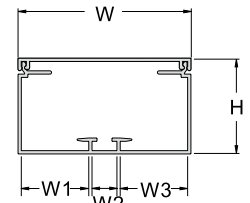

WD-11060WE

0108 KSS WIRING DUCT CONNECTOR

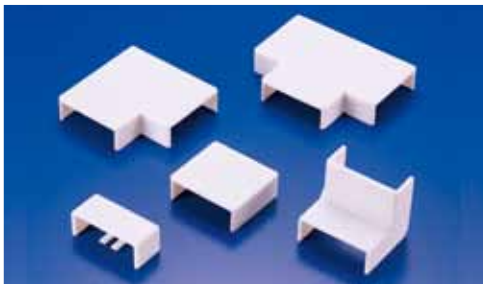

- Material: UL approved ABS, 94HB
- Color: White

UNIT : mm

Connectors	Type	Item No.	Used With	Packing	
	MID-WAY CONNECTOR	WDM-2010WE	WD-2010-2WE	20 pcs	
		WDM-3010WE	WD-3010-2WE		
		WDM-4010WE	WD-4010-3WE		
		WDM-5020WE	WD-5020-3WE		
	"T" TYPE	WDT-2010WE	WD-2010-2WE		
		WDT-3010WE	WD-3010-2WE		
		WDT-4010WE	WD-4010-3WE		
		WDT-5020WE	WD-5050-3WE		
	INSIDE CORNER	WDI-2010WE	WD-2010-2WE		10 pcs
		WDI-3010WE	WD-3010-2WE		
		WDI-4010WE	WD-4010-3WE		
		WDI-5020WE	WD-5020-3WE		
		WDI-11060WE	WD-11060WE		

Connectors	Type	Item No.	Used With	Packing
	OUTSIDE CORNER	WDO-2010WE	WD-2010-2WE	20 pcs
		WDO-3010WE	WD-3010-2WE	
		WDO-4010WE	WD-4010-3WE	
		WDO-5020WE	WD-5020-3WE	
		WDO-11060WE	WD-11060WE	
	"L" TYPE	WDL-2010WE	WD-2010-2WE	20 pcs
		WDL-3010WE	WD-3010-2WE	
		WDL-4010WE	WD-4010-3WE	
		WDL-5020WE	WD-5050-3WE	
	END PIECE	WDE-2010WE	WD-2010-2WE	20 pcs
		WDE-3010WE	WD-3010-2WE	
		WDE-4010WE	WD-4010-3WE	
		WDE-5020WE	WD-5020-3WE	

0110 KSS DECORATION WIRING DUCT



- Material: Warp proof self-extinguishing UL approved PVC, 94V-0 flammability rating, M1 rating NF fire resistant test.
- Color: Grey. (Brown , Dark Brown , White , Milk , Light Grained , Dark Grained available.)
- Vicat softening point: 86°C
- UL Test up to 50°C
- Feature: All sizes feature same height in 11mm which are especially designed for flat cables.
- Provides a round fixing hole at the duct base. The duct bottom is with adhesive tape too. Cloth adhesive and foam adhesive are available.

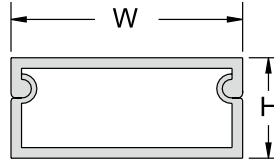

UNIT : mm

Item No.		Color	W	H	Wires to be Contained 0.8 mm	L
Without Adhesive Tape	With Adhesive Tape					
TF-1	TF-1T	Grey	12.7 (1/2")	11	1-4	2M
TF-2	TF-2T	Grey	19.0 (3/4")	11	2-6	
TF-3	TF-3T	Grey	25.4 (1")	11	5-9	
TF-4	TF-4T	Grey	31.8 (1 1/4")	11	6-12	
TF-5	TF-5T	Grey	38.1 (1 1/2")	11	10-18	
TF-6	TF-6T	Grey	50.8 (2")	11	15-25	
TF-11	TF-11T	Grey	12.7 (1/2")	11	1-4	1M
TF-11BN	TF-11TBN	Brown				
TF-11DB	TF-11TDB	Dark Brown				
TF-11WE	TF-11TWE	White				
TF-11MW	TF-11TMW	Milk				
TF-11LX	TF-11TLX	Light Grained				
TF-11DX	TF-11TDX	Dark Grained				
TF-21	TF-21T	Grey	19.0 (3/4")	11	2-6	
TF-21BN	TF-21TBN	Brown				
TF-21DB	TF-21TDB	Dark Brown				
TF-21WE	TF-21TWE	White				
TF-21MW	TF-21TMW	Milk				
TF-21LX	TF-21TLX	Light Grained				
TF-21DX	TF-21TDX	Dark Grained				
TF-21BK	TF-21TBK	Black				
TF-31	TF-31T	Grey	25.4 (1")	11	5-9	
TF-31BN	TF-31TBN	Brown				
TF-31DB	TF-31TDB	Dark Brown				
TF-31WE	TF-31TWE	White				
TF-31MW	TF-31TMW	Milk				
TF-31LX	TF-31TLX	Light Grained				
TF-31DX	TF-31TDX	Dark Grained				
TF-31BK	TF-31TBK	Black				

Item No.		Color	W	H	Wires to be Contained 0.8 mm	L
Without Adhesive Tape	With Adhesive Tape					
TF-41	TF-41T	Grey	31.8 (1 1/4")	11	6-12	1M
TF-41BN	TF-41TBN	Brown				
TF-41DB	TF-41TDB	Dark Brown				
TF-41WE	TF-41TWE	White				
TF-41MW	TF-41TMW	Milk				
TF-41LX	TF-41TLX	Light Grained				
TF-41DX	TF-41TDX	Dark Grained				
TF-51	TF-51T	Grey	38.1 (1 1/2")	11	10-18	
TF-51BN	TF-51TBN	Brown				
TF-51DB	TF-51TDB	Dark Brown				
TF-51WE	TF-51TWE	White				
TF-51MW	TF-51TMW	Milk				
TF-51LX	TF-51TLX	Light Grained				
TF-51DX	TF-51TDX	Dark Grained				
TF-61	TF-61T	Grey	50.8 (2")	11	15-25	
TF-61BN	TF-61TBN	Brown				
TF-61DB	TF-61TDB	Dark Brown				
TF-61WE	TF-61TWE	White				
TF-61MW	TF-61TMW	Milk				
TF-61LX	TF-61TLX	Light Grained				
TF-61DX	TF-61TDX	Dark Grained				

● The color cards are for reference only.

■ Double-Sided Tape :

Adhesive Type	Usage Feature	Temperature	Suitable Adhere to
Acrylic Base Adhesive	To absorb the shock and good resistance to heat	80°C	Tile, Marble, Painted board, board, Stainless steel, Iron Plate, Painted Plate, PP, PE, EVA
Rubber Base Adhesive	with excellent adhesion and holding power	50°C	

● A Usage Instruction : Adhere/stick surface need to be without dust, wax, oil and water

0112 KSS DECORATION WIRING DUCT CONNECTOR



- Material: UL approved ABS, 94HB
- Color: Grey, Brown(BN), Dark Brown(DB), White(WE), Milk(MW). e.g. TFM-2MW

UNIT : mm

Connectors	Type	Item No.	Used With	Packing
	MID-WAY CONNECTOR	TFM-1	TF-1	20 pcs
		TFM-2	TF-2	
		TFM-3	TF-3	
		TFM-4	TF-4	
		NEW TFM-5	TF-5	
		NEW TFM-6	TF-6	
	"T" TYPE	TFT-1	TF-1	
		TFT-2	TF-2	
		TFT-3	TF-3	
		TFT-4	TF-4	
		NEW TFT-5	TF-5	
		NEW TFT-6	TF-6	
	INSIDE CORNER	TFI-1	TF-1	
		TFI-2	TF-2	
		TFI-3	TF-3	
		TFI-4	TF-4	
		NEW TFI-5	TF-5	
		NEW TFI-6	TF-6	

Connectors	Type	Item No.	Used With	Packing
	OUTSIDE CORNER	TFO-1	TF-1	20 pcs
		TFO-2	TF-2	
		TFO-3	TF-3	
		TFO-4	TF-4	
		NEW TFO-5	TF-5	
		NEW TFO-6	TF-6	
	"L" TYPE	TFL-1	TF-1	
		TFL-2	TF-2	
		TFL-3	TF-3	
		TFL-4	TF-4	
		NEW TFL-5	TF-5	
		NEW TFL-6	TF-6	
	END PIECE	TFE-1	TF-1	
		TFE-2	TF-2	
		TFE-3	TF-3	
		TFE-4	TF-4	
		NEW TFE-5	TF-5	
		NEW TFE-6	TF-6	

0113 KSS ONE PIECE WIRING DUCT



UNIT : mm



Item No.		W	H	Length
Without Tape	With adhesive Tape			
TF-0905IY	TF-0905TIY	9.2	2.9	2M
TF-1313IY	TF-1313TIY	13.2	10.8	

- Material: Warp proof self-extinguishing UL approved PVC, **94V-0** flammability rating, M1 rating NF fire resistant test.
- Color: Ivory.
- Vicat softening point: 86°C
- One piece design. Combines duct base together with its lip. Easy for application and save working time.
- Supplied with cloth adhesive. Foam adhesive is available upon request.

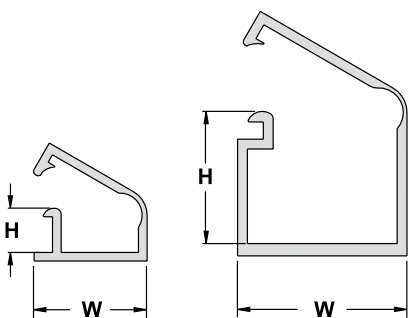

TF-0905IY

TF-1313IY

0113 KSS ONE PIECE WIRING DUCT



UNIT : mm



Item No.	W	H	Length
OS-2012TWE	20.3	11.9	1.83M with adhesive tape
OS-4020TWE	38.8	19.3	
OS-6322TWE	62.8	22.0	

- Material: Warp proof self-extinguishing UL approved PVC, 94V-0 flammability rating, M1 rating NF fire resistant test.
- Color: White.
- Vicat softening point: 86°C
- One piece surface raceway is a single channel designed to route, protect and conceal video or power cabling, can be opened and closed repeatedly without cracking.
- Factory applied adhesive backing speeds installation.
- Supplied with cloth adhesive. Foam adhesive is available upon request.

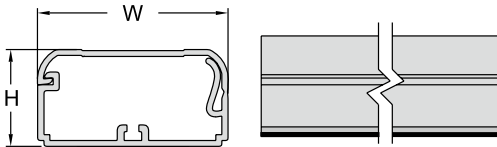

0114 KSS ELECTRICAL BOX



UNIT : mm



Item No.	Thread	Suitable Wiring Duct W x H	Packing
ELBF-1WE1	UNC #6-32	20X12, 32X12, 40X16, 40X25	1 Set
ELBF-2WE1	W 1/8-40	60X16, TF-2, TF-4, TF-5	

- Material: UL approved ABS, 94HB
- Color: White
- Measurement lines on four sides of base and cover.
- Designed upper cover and base with score lines outside provide the installation solution for wiring duct.

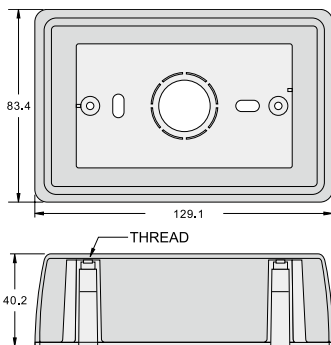

0113 KSS ONE PIECE WIRING DUCT



UNIT : mm



NEW

Item No.		W	H	Length
Without Tape	With adhesive Tape			
OP-2013WE	OP-2013TWE	19.5	13.8	1.83M
OP-3220WE	OP-3220TWE	31.8	19.6	
OP-4527WE	OP-4527TWE	45.1	27.0	

- Material: Warp proof self-extinguishing UL approved PVC, 94V-0 flammability rating, M1 rating NF fire resistant test.
- Color: White.
- Vicat softening point: 86°C
- One piece surface raceway is a single channel designed to route, protect and conceal video or power cabling, can be opened and closed repeatedly without cracking.
- Factory applied adhesive backing speeds installation.

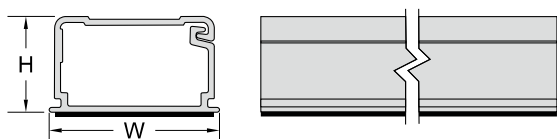

0113 KSS ONE PIECE WIRING DUCT CONNECTOR



NEW

- Material: UL approved ABS, 94HB.
- Color: White.

Connectors	Type	Item No.	Used With	Packing
	MID-WAY CONNECTOR	OPM-2013WE2	OP-2013WE	5pcs
		OPM-3220WE2	OP-3220WE	
		OPM-4527WE2	OP-4527WE	
	"T" TYPE	OPT-2013WE2	OP-2013WE	
		OPT-3220WE2	OP-3220WE	
		OPT-4527WE2	OP-4527WE	
	INSIDE CORNER	OPI-2013WE2	OP-2013WE	
		OPI-3220WE2	OP-3220WE	
		OPI-4527WE2	OP-4527WE	
	DROP CHILING	OPC-2013WE2	OP-2013WE	
		OPC-3220WE2	OP-3220WE	
		OPC-4527WE2	OP-4527WE	

Connectors	Type	Item No.	Used With	Packing
	OUTSIDE CORNER	OPO-2013WE2	OP-2013WE	5pcs
		OPO-3220WE2	OP-3220WE	
		OPO-4527WE2	OP-4527WE	
	"L" TYPE	OPL-2013WE2	OP-2013WE	
		OPL-3220WE2	OP-3220WE	
		OPL-4527WE2	OP-4527WE	
	END PIECE	OPE-2013WE2	OP-2013WE	
		OPE-3220WE2	OP-3220WE	
		OPE-4527WE2	OP-4527WE	

0115 KSS TELEPHONE WIRING DUCT



- Material: Warp proof self-extinguishing UL approved PVC, 94V-0 flammability rating, M1 rating NF fire resistant test.
- Color: Grey. (Brown, Dark Brown, White, Milk, Light Grained, Dark Grained available.)
- Vicat softening point: 86°C
- UL Test up to 50°C
- Length: 1M (2M available upon request)
- Function: Suitable for telecommunications, surveillance systems and other special environment.
- With excellent adhesion cloth tape on the duct base. The foam adhesive is available upon request.

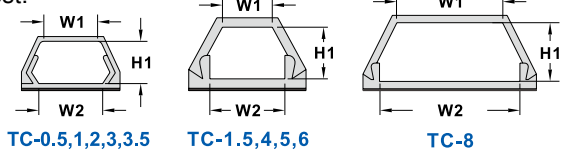

Item No.	Color	W1	W2	H1	Wires to be Contained	Length
TC-0.5	Grey	7	5	4.5	1 pcs	1M With Adhesive Tape
TC-0.5BN	Brown					
TC-0.5MW	Milk					
TC-1	Grey	6	7	4	1 pcs	
TC-1BN	Brown					
TC-1DB	Dark Brown					
TC-1WE	White					
TC-1MW	Milk					
TC-1LX	Light grained					
TC-1DX	Dark grained	6	8	7.4	1~2 pcs	
TC-1BK	Black					
TC-1.5	Grey					
TC-1.5BN	Brown					
TC-1.5MW	Milk	8	8	6	2~3 pcs	
TC-1.5LX	Light grained					
TC-1.5DX	Dark grained					
TC-2	Grey					
TC-2BN	Brown	10	10	7	3~4 pcs	
TC-2DB	Dark Brown					
TC-2WE	White					
TC-2MW	Milk					
TC-2LX	Light grained	10.5	14.5	9.5	4~5pcs	
TC-2DX	Dark grained					
TC-2BK	Black					
TC-3	Grey					
TC-3BN	Brown	10.5	14.5	9.5	4~5pcs	
TC-3DB	Dark Brown					
TC-3WE	White					
TC-3MW	Milk	10.5	14.5	9.5	4~5pcs	
TC-3LX	Light grained					
TC-3DX	Dark grained					
TC-3BK	Black	10.5	14.5	9.5	4~5pcs	
TC-3.5	Grey					
TC-3.5BN	Brown					
TC-3.5DB	Dark Brown	10.5	14.5	9.5	4~5pcs	
TC-3.5WE	White					
TC-3.5MW	Milk					

Item No.	Color	W1	W2	H1	Wires to be Contained	Length
TC-3.5WE	White	9.5	14.5	9.5	4~5 pcs	1M With Adhesive Tape
TC-3.5MW	Milk					
TC-3.5LX	Light grained					
TC-3.5DX	Dark grained					
TC-4	Grey	12	15	10	4~7 pcs	
TC-4BN	Brown					
TC-4DB	Dark Brown					
TC-4WE	White					
TC-4MW	Milk					
TC-4LX	Light grained					
TC-4DX	Dark grained	10	17	13	7~9 pcs	
TC-4BK	Black					
TC-5	Grey					
TC-5BN	Brown					
TC-5DB	Dark Brown	11	19	16	10~15 pcs	
TC-5WE	White					
TC-5MW	Milk					
TC-5LX	Light grained					
TC-5DX	Dark grained	30	37	16	30~40 pcs	
TC-5BK	Black					
TC-6	Grey					
TC-6BN	Brown					
TC-6DB	Dark Brown	30	37	16	30~40 pcs	
TC-6WE	White					
TC-6MW	Milk					
TC-6LX	Light grained	30	37	16	30~40 pcs	
TC-6DX	Dark grained					
TC-6BK	Black					
TC-8	Grey	30	37	16	30~40 pcs	
TC-8BN	Brown					
TC-8WE	White					
TC-8MW	Milk					
TC-8LX	Light grained	30	37	16	30~40 pcs	
TC-8DX	Dark grained					

■ The above color cards are for reference only.

0116 KSS TELEPHONE WIRING DUCT CONNECTOR



- Material: UL approved ABS, 94HB
- Color: Grey, Brown(BN), Dark Brown(DB), White(WE), Milk(MW). e.g. TCM-2MW

UNIT : mm

Connectors	Type	Item No.	Used With	Packing
	MID-WAY CONNECTOR	TCM-1	TC-1	20 pcs
		TCM-2	TC-2	
		TCM-3	TC-3	
		TCM-4	TC-4	
		TCM-5	TC-5	
		TCM-6	TC-6	
	"T" TYPE	TCT-1	TC-1	
		TCT-2	TC-2	
		TCT-3	TC-3	
		TCT-4	TC-4	
		TCT-5	TC-5	
		TCT-6	TC-6	
	INSIDE CORNER	TCI-1	TC-1	
		TCI-2	TC-2	
		TCI-3	TC-3	
		TCI-4	TC-4	
		TCI-5	TC-5	
		TCI-6	TC-6	

Connectors	Type	Item No.	Used With	Packing
	OUTSIDE CORNER	TCO-1	TC-1	20 pcs
		TCO-2	TC-2	
		TCO-3	TC-3	
		TCO-4	TC-4	
		TCO-5	TC-5	
		TCO-6	TC-6	
	"L" TYPE	TCL-1	TC-1	
		TCL-2	TC-2	
		TCL-3	TC-3	
		TCL-4	TC-4	
		TCL-5	TC-5	
		TCL-6	TC-6	
	END PIECE	TCE-1	TC-1	
		TCE-2	TC-2	
		TCE-3	TC-3	
		TCE-4	TC-4	
		TCE-5	TC-5	
		TCE-6	TC-6	

0116 KSS TELEPHONE WIRING DUCT CONNECTOR



- Material: UL approved ABS, 94HB
- Color: Grey, Brown(BN), Dark Brown(DB), White(WE), Milk(MW). e.g. TCM-0.5MW

UNIT : mm

Connectors	Type	Item No.	Used With	Packing
	MID-WAY CONNECTOR	TCM-0.5	TC-0.5	20 pcs
	"T" TYPE	TCT-0.5	TC-0.5	
	INSIDE CORNER	TCI-0.5	TC-0.5	

Connectors	Type	Item No.	Used With	Packing
	OUTSIDE CORNER	TCO-0.5	TC-0.5	20 pcs
	"L" TYPE	TCL-0.5	TC-0.5	

0118 KSS TELEPHONE WIRING DUCT (SELF-ADHESIVE)



UNIT : mm

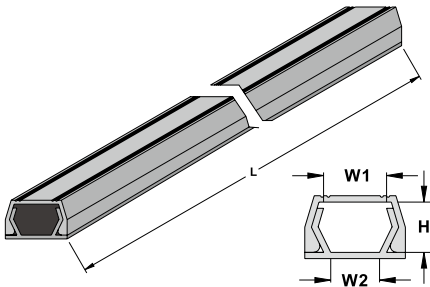

Item No.	Color	W1	W2	H	Length	Connector	Standard Color
JD-1	Grey	10.4	8.6	8.0	1M With Adhesive Tape	JDT-1, JDM-1	Grey For Color add Code MW:Milk WE:White BN:Brown DB:Dark Brown
JD-1BN	Brown					JDI-1, JDO-1	
JD-1MW	Milk					JDL-1, JDE-1	
JD-2	Grey	14.5	11.5	8.0		JDT-2, JDM-2	
JD-2BN	Brown					JDI-2, JDO-2	
JD-2MW	Milk					JDL-2, JDE-2	
JD-3	Grey	18.8	16.4	10.8		JDT-3, JDM-3	
JD-3BN	Brown					JDI-3, JDO-3	
JD-3MW	Milk					JDL-3, JDE-3	
JD-4	Grey	23.5	19.5	12.2		JDT-4, JDM-4	
JD-4BN	Brown					JDI-4, JDO-4	
JD-4MW	Milk					JDL-4, JDE-4	

- Material: Warp proof self-extinguishing UL approved PVC, 94V-0 flammability rating, M1 rating NF fire resistant test.
- Color: Grey. (Milk, White, Brown available on request)
- Vicat softening point: 86°C
- Backed with high quality self-adhesive tape to facilitate wire application.
- Length: 1M (2M available upon request)
- Application: Designed to protect wire on floor

CONNECTORS TYPE :

MID-WAY CONNECTOR : JDM-1

OUTSIDE CORNER : JDO-1

"T" TYPE : JDT-1

"L" TYPE : JDL-1

INSIDE CORNER : JDI-1

■ The above color cards are for reference only.

0119 KSS ADHESIVE TAPE



UNIT : mm



Item No.	Width	Packing
DT-8	8	100M
DT-12	12	
DT-14	14	
DT-18	18	
DT-23	23	

- Duct tape with high-performance adhesive to secure surface installation.
- Designed to meet all industry demands and applications.

0119 KSS DOUBLE-COATED FOAM TAPE



UNIT : mm

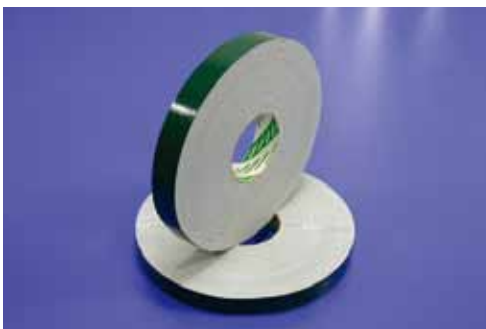

Item No.	Width	Packing
DF-8	8	50M
DF-13	13	
DF-18	18	
DF-23	23	
DF-28	28	30M

- Duct tape with high-performance adhesive to secure surface installation.
- Designed to meet all industry demands and applications.

0120 KSS U TYPE WIRING DUCT



UNIT : mm

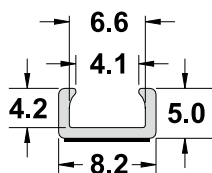

Item No.	Suitable wire	Length
TD-1	6.5	2M with adhesive tape

- Material: Transparent PVC
- Application: Peer off the adhesive tape and stick to clean, oil-free surface. Snap wire into the duct with fingertip pressure.

0121 KSS ROUND INSULATING CONDUIT



UNIT : mm

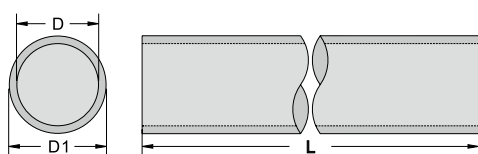

Item No.	D	D1	Length
OD-16SIY	14.0	16	2M
OD-20SIY	17.6	20	
OD-20IY	16.2	20	
OD-25SIY	22.4	25	
OD-25IY	21.0	25	
OD-32SIY	29.0	32	
OD-40SIY	36.4	40	

- Material: Warp proof self-extinguishing UL approved PVC, 94V-0 flammability rating, M1 rating NF fire resistant test.
- Color : Ivory
- Vicat softening point: 86°C

0122 KSS OVAL INSULATING CONDUIT



UNIT : mm

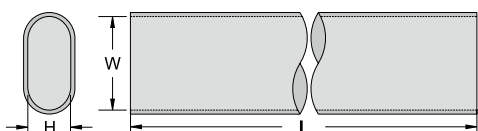

Item No.	W	H	Length
OV-13IY	11.0	5.9	2M
OV-16IY	14.9	7.9	
OV-20IY	20.6	9.8	
OV-25IY	25.2	11.8	

- Material: Warp proof self-extinguishing UL approved PVC, 94V-0 flammability rating, M1 rating NF fire resistant test.
- Color : Ivory
- Vicat softening point: 86°C

0124 KSS WIRING DUCT & CABLE CLIP



UNIT : mm



Item No.	A	B	C	D	Length
EX-1	10.9	24.8	21.6	28.2	2M
EX-2	5.0	14.4	9.5	16.6	

- Material: Warp proof self-extinguishing UL approved PVC, 94V-0 flammability rating, M1 rating NF fire resistant test.
- Color : Grey
- Vicat softening point: 86°C
- Snap the design lock into the stand aluminum frame.
- For containing wire inside professionally.

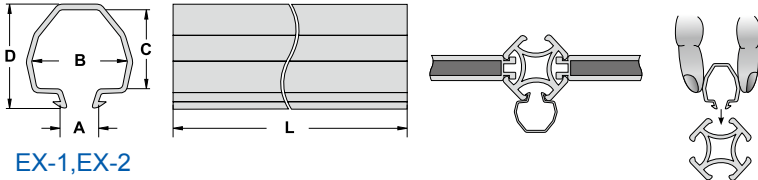

EX-1,EX-2

0124 KSS CABLE CLIP



UNIT : mm



Item No.	A	B	C	D	Packing
EX-8	15.1	6.0	16.8	23.0	100 pcs
EX-9	13.0	5.0	15.0	21.5	

- Material :PE
- Applied on alum pole of exhibition. EX-8 to fix cable and EX-9 to fix poster or used as hook.

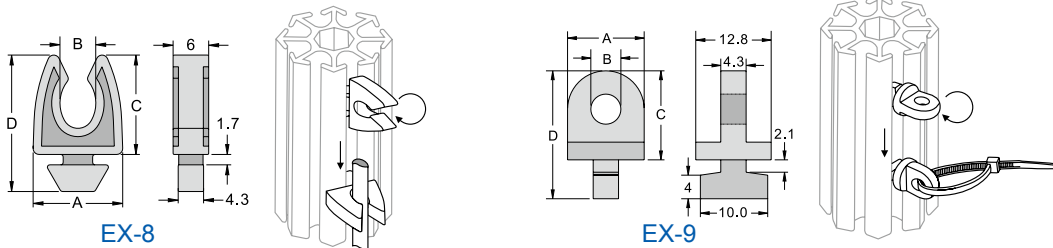

EX-8

EX-9

0127 KSS ROUND TYPE WIRING DUCT WITH ALUMINUM COVER



UNIT : mm



Item No.	W	W1	H	H1	Length
ARD-50	55.0	19.5	12.6	9.2	1M With Adhesive Tape
ARD-70	67.6	37.0	18.5	15.1	
ARD-90	88.2	45.0	17.2	14.3	
ARD-120	117.0	68.0	23.4	19.3	

- Material :Aluminum alloy Lid. Warp proof self-extinguishing UL approved PVC, 94V-0 flammability rating, M1 rating NF fire resistant test Vicat softening point: 86°C.
- Construct : Set of cover and base, self-adhesive tape backed on base for easy installation.
- Function : Suitable for telecommunication, networking, security system, computer system, monitor and other wiring application.
- Feature :
 - 1.High-impact aluminum cover to protect network communication from disconnection due to strong collide.
 - 2.Firm round cover design suitable for floor wiring application to facilitate trolley pass and avoid trips.
 - 3.Special streak design cover to avoid slip. Shining cover facilitate for decoration and suitable for department store, supermarket, shopping mall, station, hotel, hospital, office and any other public area.

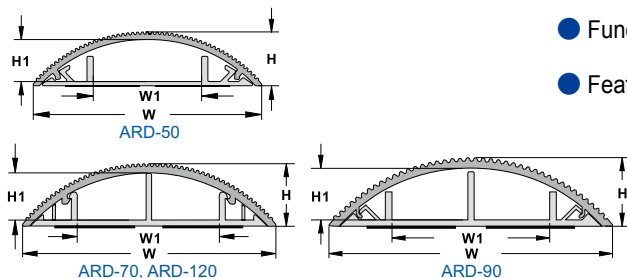

0125 KSS ROUND TYPE WIRING DUCT



CONNECTOR COVER



CONNECTOR BASE

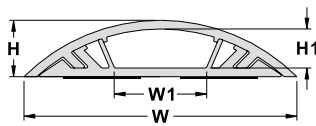

RD-20,30,40,50,60

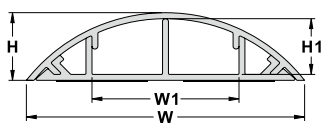

RD-70,90,120

CONNECTOR COVER TYPE :

MID-WAY CONNECTOR	: RDM-20
"L" TYPE	: RDL-20
OUTSIDE CORNER	: RDO-20
INSIDE CORNER	: RDI-20
"T" TYPE	: RDT-20
END PIECE	: RDE-20

CONNECTOR BASE TYPE :

"L" TYPE	: RBL-60
"T" TYPE	: RBT-60



OLD TYPE

NEW TYPE

- Material: Warp proof self-extinguishing UL approved PVC, 94V-0 flammability rating, M1 rating NF fire resistant test.
- Color: Grey. (Brown, Milk, Light grained, Dark Grained available on request)
- Vicat softening point: 86°C
- Backed with high quality double sided tape for permanent stick. Good for floor wiring to facilitate trolley pass and to avoid trips.
- Special grooves design to avoid slips. Shining cover facilitate for decoration and suitable for department store, supermarket, shopping mall, station, hotel, hospital, office and any other public area.

UNIT : mm

Item No.	Color	W	W1	H	H1	Length	Connector lid Item No.	Connector base Item No.
RD-20	Grey	20	8	6	4	1M With Adhesive Tape	RDT-20,RDM-20 RDI-20,RDO-20 RDL-20,RDE-20	RBL-20 RBT-20
RD-20BN	Brown							
RD-20MW	Milk							
RD-20LX	Light Grained							
RD-20DX	Dark Grained							
RD-30	Grey	30	11	8	6		RDT-30,RDM-30 RDI-30,RDO-30 RDL-30,RDE-30	RBL-30 RBT-30
RD-30BN	Brown							
RD-30MW	Milk							
RD-30LX	Light Grained							
RD-30DX	Dark Grained	40	16	9.5	7		RDT-40,RDM-40 RDI-40,RDO-40 RDL-40,RDE-40	RBL-40 RBT-40
RD-40	Grey							
RD-40BN	Brown							
RD-40MW	Milk							
RD-40LX	Light Grained	50	20	11	8		RDT-50,RDM-50 RDI-50,RDO-50 RDL-50,RDE-50	RBL-50 RBT-50
RD-40DX	Dark Grained							
RD-50	Grey							
RD-50BN	Brown							
RD-50MW	Milk	60	30	13	9		RDT-60,RDM-60 RDI-60,RDO-60 RDL-60,RDE-60	RBL-60 RBT-60
RD-50LX	Light Grained							
RD-50DX	Dark Grained							
RD-60	Grey							
RD-60BN	Brown	70	40	15	10	RDT-70,RDM-70 RDI-70,RDO-70 RDL-70,RDE-70	RBL-70 RBT-70	
RD-60MW	Milk							
RD-60LX	Light Grained							
RD-60DX	Dark Grained							
RD-70	Grey	90	45	19	15	RDT-90,RDM-90 RDI-90,RDO-90 RDL-90,RDE-90	RBL-90 RBT-90	
RD-70BN	Brown							
RD-70MW	Milk							
RD-70LX	Light Grained							
RD-70DX	Dark Grained	120	70	25	21	RDT-120,RDM-120 RDI-120,RDO-120 RDL-120,RDE-120	RBL-120 RBT-120	
RD-90	Grey							
RD-90BN	Brown							
RD-90MW	Milk							
RD-90LX	Light Grained	RD-120DX	Dark Grained					
RD-90DX	Dark Grained							
RD-120	Grey							
RD-120BN	Brown							
RD-120MW	Milk							
RD-120LX	Light Grained							
RD-120DX	Dark Grained							

■ The above color cards are for reference only.

0126 KSS ROUND TYPE WIRING DUCT



- Material: Warp proof self-extinguishing UL approved PVC, 94V-0 flammability rating, M1 rating NF fire resistant test.
- Color: Grey. (Brown, Milk available)
- Vicat softening point: 86°C
- Backed with high quality double sided tape for permanent stick. Good for floor wiring to facilitate trolley pass and to avoid trips.

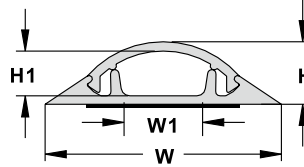

UNIT : mm

Item No.	Color	W	W1	H	H1	Length
RDA-30	Grey	28.8	11.0	7.4	5.2	1M With Adhesive Tape
RDA-30BN	Brown					
RDA-30MW	Milk					
RDA-40	Grey	38.5	18.8	11.5	8.5	
RDA-40BN	Brown					
RDA-40MW	Milk					
RDA-50	Grey	50.0	23.3	12.3	8.8	
RDA-50BN	Brown					
RDA-50MW	Milk					
RDA-60	Grey	60.0	33.3	13.8	10.7	
RDA-60BN	Brown					
RDA-60MW	Milk					
RDA-70	Grey	70.0	44.0	17.0	13.0	
RDA-70BN	Brown					
RDA-70MW	Milk					
RDA-90	Grey	87.5	57.5	21.0	16.5	
RDA-90BN	Brown					
RDA-90MW	Milk					
RDA-120	Grey	118.5	85.5	30.0	26.5	
RDA-120BN	Brown					
RDA-120MW	Milk					

※This product has similar function with 0125 RD-duct except for some difference in out look appearance.

■ The above color cards are for reference only.

0128 KSS SOFT WIRING DUCT



- Material:PVC
- Color: Grey. (Brown, Milk, Black available)
- Soft pvc products, packed in roll for easy storage.
- Cut to required length for temporary wiring or permanent application. Supplied with double sided tape.

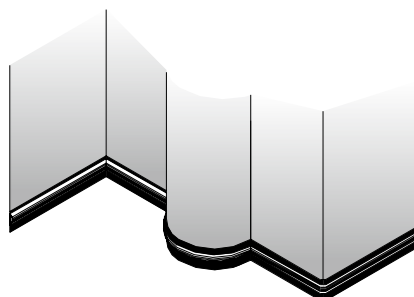
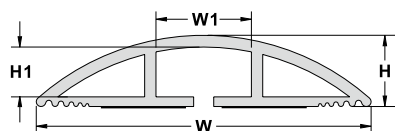

UNIT : mm

Item No.		Color	W	W1	H	H1
1M With Adhesive Tape	6 Feet (183 cm) Supplied With Adhesive Tape					
SRD-251	SRD-25	Grey	25.4	7.4	5.8	3.8
SRD-251BN	SRD-25BN	Brown				
SRD-251MW	SRD-25MW	Milk				
SRD-251BK	SRD-25BK	Black				
SRD-501	SRD-50	Grey	50.8	14.8	11.6	7.8
SRD-501BN	SRD-50BN	Brown				
SRD-501MW	SRD-50MW	Milk				
SRD-501BK	SRD-50BK	Black				
SRD-651	SRD-65	Grey	66.0	19.0	15.3	10.9
SRD-651BN	SRD-65BN	Brown				
SRD-651MW	SRD-65MW	Milk				
SRD-651BK	SRD-65BK	Black				
SRD-751	SRD-75	Grey	76.2	22.0	17.4	11.6
SRD-751BN	SRD-75BN	Brown				
SRD-751MW	SRD-75MW	Milk				
SRD-751BK	SRD-75BK	Black				
SRD-1001	SRD-100	Grey	101.6	29.4	23.2	15.4
SRD-1001BN	SRD-100BN	Brown				
SRD-1001MW	SRD-100MW	Milk				
SRD-1001BK	SRD-100BK	Black				

■ The above color cards are for reference only.

0131 KSS COVERING DUCT



UNIT : mm



Item No.	W	W1	H	H1	Length
CD-3820YW1	67.2	38.0	22.3	19.8	1.2M

- Material: Warp proof self-extinguishing UL approved PVC, 94V-0 flammability rating, M1 rating NF fire resistant test.
- Color: Yellow.
- Vicat softening point: 86°C
- Function : Put wires inside the duct and fix the duct on the floor or wall.
- Feature : Can install wires before duct application. To protect wires from damage.

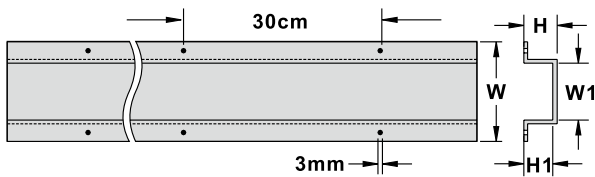

0130 KSS SOFT SPLIT – INSERT WIRING DUCT



UNIT : mm



Item No.	Color	W	W1	H	H1	Length
RSD-8WE	White	12	8.0	10.8	7.0	1M
RSD-10BN	Brown	15	10.5	13.8	9.8	With Adhesive Tape

- Material : PVC
- Hard base extruded PVC supplied with double sided adhesive base.
- Split insert design of duct body (soft) for easy insertion and removal of wire application.
- Suitable for wire dia. under 10mm.

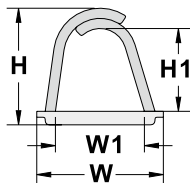

0133 KSS ONE PIECE WIRING DUCT



UNIT : mm



Item No.	W	W1	H	H1	Length	Connector	Connector Packing
RTF-10WE	13.1	11.6	10.8	8.2	1.5M With Adhesive Tape	"L" TYPE: RTFL-10WE INSIDE: RTFI-10WE OUTSIDE: RTFO-10WE MID-WAY: RTFM-10WE	20pcs

- Material: Warp proof self-extinguishing UL approved PVC, 94V-0 flammability rating, M1 rating NF fire resistant test.
- Color: White.
- Vicat softening point: 86°C
- Feature : One piece design to facilitate application and time saving.

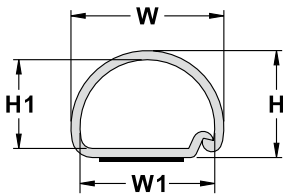



CABLE MARKERS

0201 KSS EC TYPE CABLE MARKER



UNIT : mm

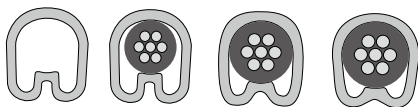

Marker tongue spans to fit various cable diameters and retracts to hold wires firmly in position.

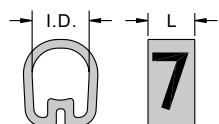

EC-TYPE
EC-TYPE CAN BE MADE IN 2 DIGIT

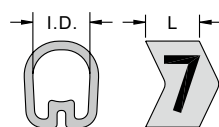

ECA-TYPE



CHEVRON CUT (ECA)

Shape	Item No.	Suitable Wire		Suitable Range I.D.	L	Std. Markings	Packing	
		sq	AWG					
Plain Cut	EC-0	0.12~0.75	26~18	2.0~3.2	4.0	Solid number or letter roll for 0,1,2,3,...9 A,B,C,...Z /,+,-,≡, blank ※a-z available as special request	1000pcs / Roll	
	EC-1	0.75~3.5	18~12	3.0~4.2	4.0		1000pcs / Roll	
	EC-2	3.5~8	12~8	3.6~7.4	5.0		500pcs / Roll	
	EC-3	8~22	8~4	5.2~10.0	5.5		250pcs / Roll	
Chevron Cut	ECA-02	0.12~0.75	26~18	2.0~3.2	4.0		Solid number or letter roll for 0,1,2,3,...9 A,B,C,...Z /,+,-,≡, blank ※a-z available as special request	1000pcs / Roll
	ECA-1	0.75~3.5	18~12	3.0~4.2	4.0			1000pcs / Roll
	ECA-2	3.5~8	12~8	3.6~7.4	5.0			500pcs / Roll
	ECA-3	8~22	8~4	5.2~10.0	5.5			250pcs / Roll

- Material: Made of finest soft grade, strong, durable PVC that will resist oil, grease, and other material erosion.
- Description:
 1. KSS EC type cable marker features high quality flexible interior to fit various cable diameters.
 2. The markers stay attached on a roller and can be despatched easily when needed.
 3. Bold print on yellow body to show your codes distinguishly. Any numbers can be composed by arranging letters and numbers in sequence to provide the necessary codes.
 4. To be fitted before the terminal is attached or solder connection made and grip cable firmly in position.

0201 KSS ECP TYPE CABLE MARKER



UNIT : mm

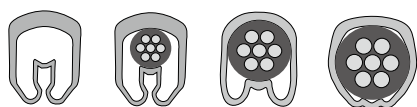

Marker tongue spans to fit various cable diameters and retracts to hold wires firmly in position.

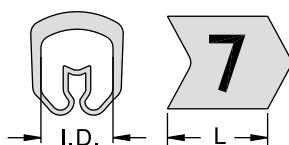

Shape	Item No.	Suitable Wire		Suitable Range I.D.	L	Std. Markings	Packing
		sq	AWG				
Chevron Cut	ECP-02	0.2~1.25	24~18	1.3~3.0	3.0	Solid number or letter roll for 0,1,2,3,...9 A,B,C,...Z /,+,-,≡, blank	1000pcs / Roll
	ECP-1	0.5~5.5	20~10	2.5~5.1	3.0		1000pcs / Roll
	ECP-2	2.0~14.0	14~6	3.6~7.6	4.0		250 pcs / Roll
	ECP-3	8.0~60.0	8~1/0	6.2~16.0	6.0		100 pcs / Bag

- Material : Made of finest soft grade, strong, durable P.V.C. that will resist oil, grease. and other material erosion.
- Description :
 1. KSS ECP type cable marker features high quality flexible interior to fit various cable diameters.
 2. The markers stay attached on a roller and can be despatched easily when needed.
 3. Bold print on yellow body to show your codes distinguishly. Any numbers can be composed by arranging letters and numbers in sequence to provide the necessary codes.
 4. Chevron cut design to keep marking in line consistently.



0201 KSS COLOR CODED CABLE MARKER



- Ordering Information: Add color code to the original Size & No.
- For Example : EC1- 0 BK

MARKER SIZE | | | COLOR OF MARKER
 | | |
 NUMBER YOU NEED

0	1	2	3	4	5	6	7	8	9
BK	BN	RD	OE	YW	GN	BE	VT	GY	WE

Marker Size	Item No. Color Coded	Marker Size	Item No. Color Coded	Marker Size	Item No. Color Coded	Marker Size	Item No. Color Coded	Marker Size	Item No. Color Coded
EC-0	EC0-0BK	EC-1	EC1-0BK	EC-2	EC2-0BK	EC-3	EC3-0BK	FM-1	FM1-0BK
	EC0-1BN		EC1-1BN		EC2-1BN		EC3-1BN		FM1-1BN
	EC0-2RD		EC1-2RD		EC2-2RD		EC3-2RD		FM1-2RD
	EC0-3OE		EC1-3OE		EC2-3OE		EC3-3OE		FM1-3OE
	EC0-4YW		EC1-4YW		EC2-4YW		EC3-4YW		FM1-4YW
	EC0-5GN		EC1-5GN		EC2-5GN		EC3-5GN		FM1-5GN
	EC0-6BE		EC1-6BE		EC2-6BE		EC3-6BE		FM1-6BE
	EC0-7VT		EC1-7VT		EC2-7VT		EC3-7VT		FM1-7VT
	EC0-8GY		EC1-8GY		EC2-8GY		EC3-8GY		FM1-8GY
	EC0-9WE		EC1-9WE		EC2-9WE		EC3-9WE		FM1-9WE

0201A KSS MARKER BOX



Item No.	Available loaded quantity of EC Cable Marker	Material
ECB-1	13 pcs	Acrylic

- To keep and verify cable marker in rolls and improve wire application. Suitable for outside wire/application by carrying one box with various markers inside.

0202 KSS FLAT CABLE MARKER



UNIT : mm



Item No.	Suitable Wire		Suitable Range	L	Std. Markings	Packing
	sq	AWG				
FM-1	2~8	14~8	3.5~6.0	5.0	Solid number or letter roll for 0,1,2,3,...9 A,B,C,...Z /,+,-,±, blank	500pcs / Roll

- Material : Made of finest soft grade, strong, durable PVC that will resist oil, grease and other material erosion.
- FLAT CABLE MARKER with its unique oval shape design provide
 - 1.slip over cable directly (for small cable)
 - 2.slip onto marker strip (for larger cable or cable bundles)

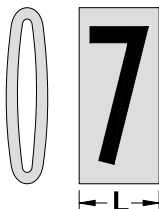

0203 KSS MARKER STRIP



UNIT : mm



Item No.	L	W	T	Available loaded quantity of FM-1 Cable Marker	Packing
MS-65	66	9	6.7	9 pcs	100 pcs
MS-100	100	9	6.95	16 pcs	
MS-135	135	9	7.0	23 pcs	
MS-135L	135	9	13.0	21 pcs	
NEW MS-170	170	9	7.0	30 pcs	

- Material : UL approved Nylon 66 (black) , 94V-2.
- Nylon 66 PLATE with cable tie fastening hole to accommodate marker pieces for easy identification of cable runs.

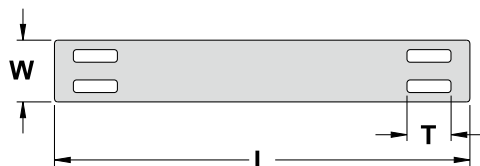

0205 KSS O TYPE CABLE MARKER



UNIT : mm

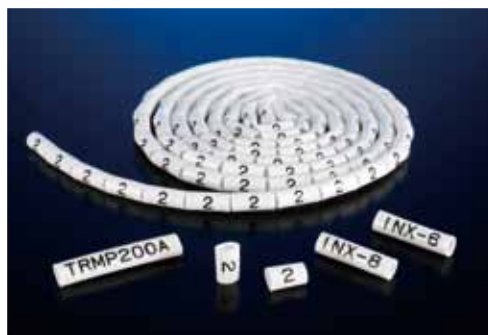

Item No.	Suitable Wire		Wire Dia. I.D.	L	Std. Markings	Packing
	I.D. sq	AWG				
OM-22S			1.3	10	Special specification is available upon request	100 pcs
OM-20S			1.5			
OM-18S			1.8			
OM-16S			1.9			
OM-0.75	0.75	18	3.0	0,1,2,.....100 A,B,C,....Z +,-,=,/,blank		
OM-1.25	1.25	16	3.2			
OM-2.0	2.0	14	3.6			
OM-3.5	3.5	12	4.2			
OM-5.5	5.5	10	5.1	0,1,2,.....9 A,B,C,....Z /,+,-,=,/,blank		
OM-8	8.0	8	6.2			
OM-14	14.0	6	7.6			
OM-22	22.0	4	9.4			

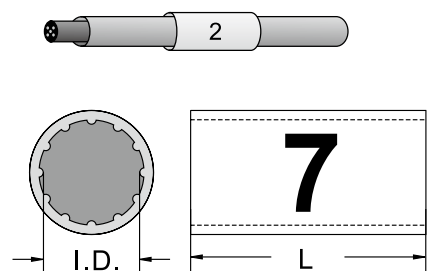

- Material: Soft PVC (white) , to resist oil , grease and other material erosion.
- Sleeve on design.
- Apply before wire termination.
- ◆ Special marking is available upon request

- AC-110
- L OUT
- AUDIO IN
- VIDEO OUT
- DC-12
- 123
- 567-80
- KSS-1

0207 KSS O TYPE MARKER TUBE

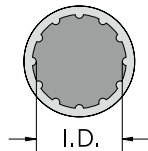

UNIT : mm

NEW

Item No.	Packing	Item No.	Packing	Suitable Wire		Wire Dia. I.D.	
				sq	AWG		
OMR-0.75	100 M	Small Spool Pack	OMR-0.75-10M	10 M	0.75	18	3.0
OMR-1.25	100 M		OMR-1.25-10M	10 M	1.25	16	3.2
OMR-2.0	100 M		OMR-2.0-10M	10 M	2.0	14	3.6
OMR-3.5	100 M		OMR-3.5-10M	10 M	3.5	12	4.2
OMR-5.5	100 M		OMR-5.5-10M	10 M	5.5	10	5.1
OMR-8	50 M		OMR-8-10M	10 M	8.0	8	6.2
OMR-8L	50 M		OMR-8L-10M	10 M	Cat.6A		7.2

Item No.	Suitable Wire		Wire Dia. I.D.	Packing	Large Spool Pack
	sq	AWG			
OMR-0.75-500M	0.75	18	3.0	500M	Large Spool Pack
OMR-1.25-550M	1.25	16	3.2	550M	
OMR-2.0-500M	2.0	14	3.6	500M	
OMR-3.5-400M	3.5	12	4.2	400M	
OMR-5.5-200M	5.5	10	5.1	200M	

- Material : Soft durable PVC (white), resist oil, grease and other material erosion.
- Feature : Air filled tubing with 12 rifling lines inside the tube helps keep it shape and is not easily twisted. Suitable for various typing machines.

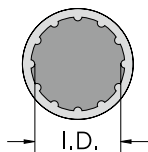

Item No.	Suitable Wire		Wire Dia. I.D.	Packing
	sq	AWG		
OMK-0.75	0.75	18	3.0	1000M / Box
OMK-1.25	1.25	16	3.2	
OMK-2.0	2.0	14	3.6	

- Material : Soft durable PVC (white), resist oil, grease and other material erosion.
- Feature : 1. Air filled tubing with 12 rifling lines inside the tube helps keep it shape and is not easily twisted. Suitable for various typing machines.
2. Packed in box to keep tube clean for printing. Good storage with 1000M per box.

0207 KSS O TYPE MARKER TUBE



UNIT : mm



Item No.	Suitable Wire		Wire Dia. I.D.	Packing
	sq	AWG		
OMJ-1.5	0.75	18	2.8	200M / Roll
OMJ-2.5	2.0	14	4.0	
OMJ-4.0	3.5	12	4.5	

- Material : Soft PVC (bright white)
- Available in special color request of bright red, Bright Yellow.



UNIT : mm

Item No.	Suitable Wire		Wire Dia. I.D.	Packing
	sq	AWG		
OMT-2.5	0.5	20	2.5	200M / Roll
OMT-3.0	0.75	18	3.0	
OMT-3.2	1.25	16	3.2	
OMT-3.5	2.0	14	3.5	
OMT-4.0	2.0	14	4.0	
OMT-4.5	3.5	12	4.5	
OMT-5.0	5.5	10	5.0	100M / Roll
OMT-5.5	5.5	10	5.5	
OMT-6.2	8.0	8	6.2	50M / Roll
OMT-6.7			6.7	
OMT-7.1	Cat.6A		7.1	

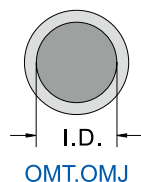

NEW
NEW

OMT-2.5-800M	0.5	20	2.5	800M / Roll
OMT-3.0-600M	0.75	18	3.0	600M / Roll
OMT-3.2-650M	1.25	16	3.2	650M / Roll
OMT-3.5-550M	2.0	14	3.5	550M / Roll
OMT-4.0-450M	2.0	14	4.0	450M / Roll
OMT-4.5-400M	3.5	12	4.5	400M / Roll
OMT-5.0-350M	5.5	10	5.0	350M / Roll
OMT-5.5-250M	5.5	10	5.5	250M / Roll

- OMT Feature : Air filled tubing with smooth design, good for various printing machines.
- OMT-6.2 suitable for Cat.5e \ Cat.6 wires.
- OMT-7.1 suitable for Cat.6A wires.

0208 KSS FLAT MARKER TUBE



UNIT : mm



NEW

Item No.	D	d1	d2	t	Packing
FMR-3	3.65	1.75	2.0	0.35	100M / Roll
FMR-4	5.10	1.90	3.0	0.40	
FMR-6	6.70	2.80	4.2	0.50	
FMR-8	7.60	3.30	5.0	0.58	
FMR-11	10.45	3.85	6.6	0.73	
FMR-13	12.30	4.80	8.0	0.75	50M / Roll
FMR-18	17.10	5.60	11.0	0.80	

- Material : Soft PVC, resist oil, grease and other material erosion.
- Feature : Flat design and good for printing machine.

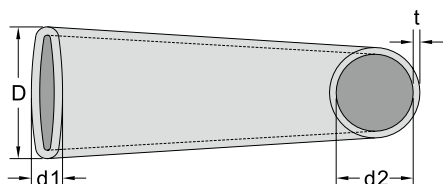

0210 KSS MARKER PLATE



UNIT : mm

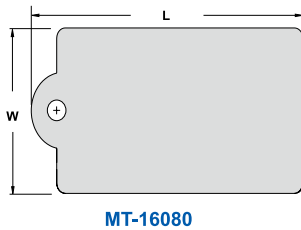
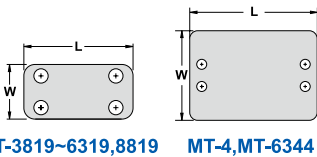
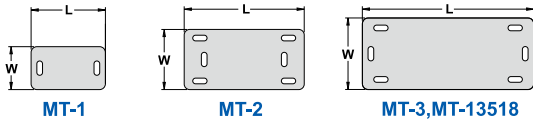
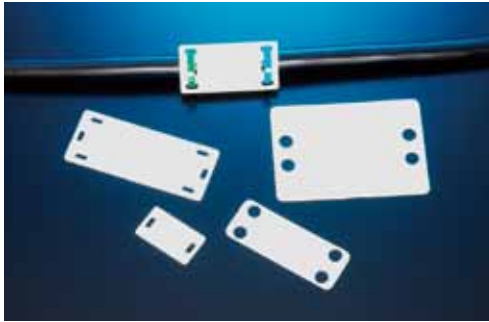

Item No.	L	W	Thickness	Packing
MT-1	26.0	15.2	1.2	100 pcs
MT-2	42.2	21.2	1.2	
MT-3	60.8	25.2	1.2	
MT-4	62.2	51.5	1.3	
MT-3819	38.5	19.1	0.4	
MT-4419	45.3	19.1	0.4	
MT-5019	50.5	19.1	0.4	
MT-6319	65.0	19.1	0.4	
MT-6344	63.8	44.8	0.4	
MT-8819	90.0	19.1	0.4	
NEW MT-13518	135.0	18.0	1.0	

- Material : UL approved Nylon 66
- Color : White
- Used to mark cable bundles for permanent identification.
- Secured with KSS cable ties extensively from CV-075 to CV-432 in variety of ways.
- For tie width : less than 4.8 mm

Item No.	L	W	Thickness	Packing
MT-16080	160.0	80.0	0.6	100 pcs

- Material : UL approved Nylon 66
- Color : White
- Used to mark cable bundles for permanent identification.
- Secured with KSS cable ties extensively from CV-075 to CV-432 in variety of ways.
- For tie width : less than 4.8 mm

0212 KSS MARKER BOX



UNIT : mm

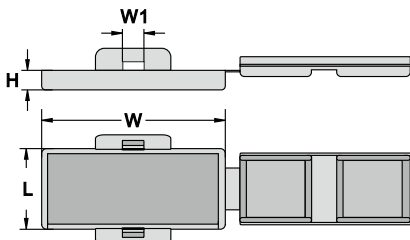

Item No.	Dimension				Marking pad	Packing
	W	L	H	W1		
MC-1	32.6	11.5	3.0	5.0	30 × 9.5	100pcs
MC-2	43.5	19.1	4.6	5.1	40 × 17	

- Material : PE Nature
- Using Method : Cut the paper in a suitable size and mark with numbers or letters you want.
- Put the paper into marker box and tie up with cable tie.
- For tie width : less than 4.8 mm

0215 KSS SELF ADHESIVE WIRE MARKER



UNIT : mm



BOOK SIZE: L:143 W:82

Item No.	L	W	Std. Markings	Packing
WM-1	25	6.0	Solid : 0,1,2,3,...100 A,B,C,...Z, +, -, $\frac{1}{2}$ Consecutive Number : 0~9, 1~34, 35~67, 68~100, A~Z	4 pcs/Leaf, 80 Leaf/Sheet, 50 Sheet/Box
WM-2	25	6.5	blank	80 Leaf/Sheet, 50 Sheet/Box
WM-3	40	10.0		30 Leaf/Sheet, 50 Sheet/Box
WMB-1	33	5.6	(0~9) @ 1 page	10 page
WMB-2	33	5.6	(A~Z,/,+,-,0~15) x 1 page	
WMB-3	33	5.6	(1~45) X 1 page	
WMB-4	33	5.6	(46~90) X 1 page	
WMB-5	33	5.6	(1~45) X 4 page (46~90) X 4 page (A~Z,/,+,-,0~15) x 2 page	

- Stick to wires for permanent identification.
- Used extensively for cable diameters after or before terminal is attached.
- Cloth type label.
- For your orders, please specify solid or consecutive and what letter (s), number (s) you need.
- ※ WMB-5 content please reference WMB-2、WMB-3、WMB-4
- ※ WM-1 has 4 pieces/sheet. WMB-1, WMB-2, WMB-3, WMB-4 and WMB-5 have 7 pieces/sheet.

SOLID NUMBER

SOLID LETTERS

CONSECUTIVE NUMBERS(0~9)

CONSECUTIVE NUMBERS (1~34)

CONSECUTIVE LETTERS (A~Z)

WMB-1

WMB-2

WMB-3

WMB-4

4 pcs/Leaf

0225 KSS OC TYPE CABLE MARKER



UNIT : mm

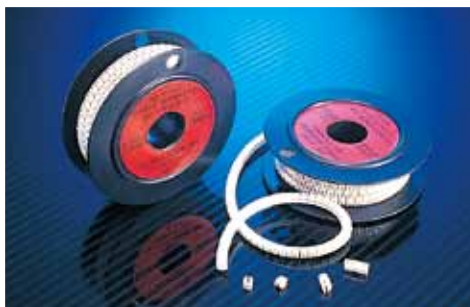

Item No.	Suitable Wire		Suitable Range mm	L	Std. Markings	Packing
	sq	AWG				
OC-1	0.5~0.75	20~18	2.5~3.0	4.0	Solid number or letter roll for 0,1,2,3,...9 A,B,C,...Z /,+,-, $\frac{1}{2}$, blank	1000 pcs / Roll
OC-2	1.25~2.0	16~14	3.2~3.6			
OC-2L	1.25~2.0	16~14	3.2~3.6			
OC-3	3.5~5.5	12~10	4.2~5.1			
OC-4	5.5~8.0	10~8	5.1~6.2			
OC-8	14	6	7.5~8.0	6.0		300 pcs / Roll

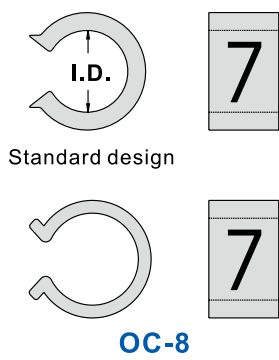

- Material: Rigid PVC
- Standard color: White body maker in black.
- Description:
 1. To be fitted after termination. The marker can be removed without breaking the terminal connection.
 2. O shape design benefit to grip the wire/cable tight.
 3. Clip on design enable it to grip wire/cable firmly in position after termination attached.
 4. Each marker will accommodate multiple wire sizes.
- ※ OC-2L has wider entrance.

0230 KSS CM TYPE CABLE MARKER



UNIT : mm



Item No.	Suitable Wire		Wire Dia. I.D.	L	Std. Markings	Packing
	sq	AWG				
CM-0.75	0.75	18	3.0	4.0	Solid number or letter roll for 0,1,2,3,...9 A,B,C,...Z /,+,-,±, blank	100 pcs
CM-1.25	1.25	16	3.2			
CM-2.0	2.0	14	3.6			
CM-3.5	3.5	12	4.2			
CM-5.5	5.5	10	5.1			
CM-8	8.0	8	6.2			

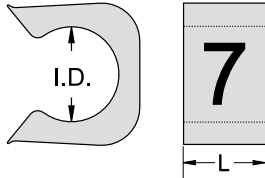

- Material : Rigid P.V.C.
- Clip on design.
- Can be applied after wire termination.

0234 KSS MB TYPE CABLE MARKER



UNIT : mm



Item No.		Suitable Wire			Suitable Range I.D.	L	Std. Markings	Packing
Yellow	White	sq	AWG	Fiber Line				
MB-0	MB-0WE	0.75	18	2.0	2.2	4.0	Solid number or letter roll for 0,1,2,3,...9 A,B,C,...Z /,+,-,±, blank	100 pcs
MB-1	MB-1WE	1.25-2.0	16-14	3.0	3.0~3.4			
MB-2	MB-2WE	3.5-5.5	12-10		4.0~5.0			
MB-3	MB-3WE	8.0	8		5.2~6.0	5.0		

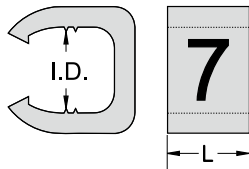

- Material : UL approved Nylon 6
- Color : Yellow, White
- Features :
 1. One size MB cable marker is suitable for different cable dia.
 2. Fast, snap-on installation.
 3. Flexible design, not easy to transfigure.
 4. High quality hot-foil stamped.
 5. Special inside stop point design makes MB marker keep in same direction, not overturn, marker read easily.

0235 KSS U TYPE CABLE MARKER



UNIT : mm



Item No.	Suitable Wire		L	H	W	W1	Packing
	sq	AWG					
UM-1	1.25~2.0	16~14	12.6	4.3	4.4	3.0	100 pcs

- Material: PP
- Color: Pink(PK1), Blue(BE1), Yellow(YW1), Green(GN1), Purple(VT1).
- Different colors for easy verification of wire funtion.

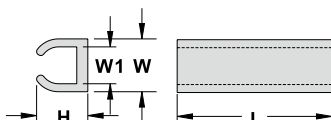

0236 KSS SM TYPE CABLE MARKER



UNIT : mm

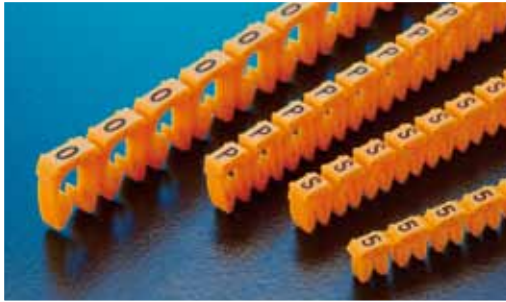

Item No.	Packing	Item No.	Packing	Suitable Wire		Suitable Range I.D.	L	Std. Markings
				mm ²	AWG			
SM-0	1000pcs (25pcsX40strips)	P-SM0	250pcs (25pcsX10strips)	0.12~0.5	26~20	1.2~2.0	2.3	0,1,2,3, ...9 A,B,C,... .Z /,+,-,=, blank
SM-1	1200pcs (30pcsX40strips)	P-SM1	300pcs (30pcsX10strips)	0.5~1.5	20~18	2.2~2.8	2.9	
SM-2	1200pcs (30pcsX40strips)	P-SM2	300pcs (30pcsX10strips)	1.5~2.5	16~14	3.0~3.6	2.8	
SM-3	800pcs (20pcsX40strips)	P-SM3	200pcs (20pcsX10strips)	4~6	12~10	4.2~5.1	2.9	

- Material : UL approved Nylon66, 94V-2
- Color : Yellow
- Yellow body with black printing

0236 KSS SM TYPE COLOR CODED CABLE MARKER



UNIT : mm



Item No.	Packing	Item No.	Packing	Suitable Wire		Suitable Range I.D.	L	Std. Markings
				mm ²	AWG			
SM-0	1000pcs (25pcsX40strips)	P-SM0	250pcs (25pcsX10strips)	0.12~0.5	26~20	1.2~2.0	2.3	0,1,2,3, ...9
SM-1	1200pcs (30pcsX40strips)	P-SM1	300pcs (30pcsX10strips)	0.5~1.5	20~18	2.2~2.8	2.9	
SM-2	1200pcs (30pcsX40strips)	P-SM2	300pcs (30pcsX10strips)	1.5~2.5	16~14	3.0~3.6	2.8	
SM-3	800pcs (20pcsX40strips)	P-SM3	200pcs (20pcsX10strips)	4~6	12~10	4.2~5.1	2.9	

Item No.	Std. Markings	Packing	Item No.	Std. Markings	Packing
PB-SM0	Individual: 0, 1, 2, 3...9	10 strips (25pcs)	PB-SM0	Serial: A ~ M N ~ Z	13 strips (25pcs)
PB-SM1	A, B, C ... Z	10 strips (15pcs)	PB-SM1		13 strips (15pcs)
PB-SM2	+, -, =, blank	10 strips (15pcs)	PB-SM2		13 strips (15pcs)
PB-SM3	Serial: 0 ~ 9	10 strips (10pcs)	PB-SM3		13 strips (10pcs)

- Material : UL approved Nylon66, 94V-2
- Feature :

1. More effective in marker assembly. It can be applied after completing of terminal assembly to the wire.
2. not easy to transfigure and beautiful, clear printing and longer lasting (not fade easily).
3. Strip off from the cutting point easily when used. Continuously SM type cable markers is string type and each one is connected.

- Ordering Information: Add color code to the original Size & No.
- For Example : SM1- 0 BK

MARKER SIZE | COLOR OF MARKER | NUMBER YOU NEED

0	1	2	3	4	5	6	7	8	9
BK	BN6	RD	OE	YW2	GN	BEC	VT	GY	WE

Marker Size	Item No. Color Coded	Marker Size	Item No. Color Coded	Marker Size	Item No. Color Coded	Marker Size	Item No. Color Coded
SM-0	SM0-0BK	SM-1	SM1-0BK	SM-2	SM2-0BK	SM-3	SM3-0BK
	SM0-1BN6		SM1-1BN6		SM2-1BN6		SM3-1BN6
	SM0-2RD		SM1-2RD		SM2-2RD		SM3-2RD
	SM0-3OE		SM1-3OE		SM2-3OE		SM3-3OE
	SM0-4YW2		SM1-4YW2		SM2-4YW2		SM3-4YW2
	SM0-5GN		SM1-5GN		SM2-5GN		SM3-5GN
	SM0-6BEC		SM1-6BEC		SM2-6BEC		SM3-6BEC
	SM0-7VT		SM1-7VT		SM2-7VT		SM3-7VT
	SM0-8GY		SM1-8GY		SM2-8GY		SM3-8GY
	SM0-9WE		SM1-9WE		SM2-9WE		SM3-9WE



CABLE TIES



SAFETY CERTIFICATION :



Underwriters Laboratories, Inc



Det Norske Veritas & Germanischer Lloyd



Underwriters Laboratories, Inc



American Bureau of Shipping



VDE Prüf- und Zertifizierungsinstitut



Conformity European



Lloyd's Register of Shipping

STORAGE AND APPLICATION :

STORAGE:

KSS Cable ties are made by high quality of Nylon 66 resin. The property of this material is in moisture absorbed and released. Cable ties require to be contained the moisture and packed in the sealed packaging to have optimal performance. Hence, the conditions for keeping the packaging of cable ties are very important.

APPLICATION:

The ideal storage temperature is around 23°C with the humidity over 50 %		Do not expose directly under sunlight except UV resistant cable ties.	
Do not open the bag before use. Please try to finish the whole package of cable ties shortly once it's opened. Seal the bag for remaining pieces to keep quality.		Avoid storing cable ties next to warm objects like heaters.	

MATERIAL PROPERTY COMPARISON :

Material		Flammability	UV resistance	High temperature	Low temperature	Weak acid	Strong acid	Weak base	Strong base	Organic solvent
Polyamide 66	Nylon 66	V-2	X	▲	▲	▲	X	★	★	●
	Nylon 66-W	V-2	●	▲	▲	▲	X	★	★	●
	Nylon 66-HS	V-2	X	●	▲	▲	X	★	★	●
	Nylon 66-V0	V-0	X	▲	▲	▲	X	★	★	●
Polyamide 6	Nylon 6	HB	X	▲	▲	▲	X	★	★	●
Polyamide12	Nylon 12	HB	●	▲	●	▲	X	★	★	●
Polypropylene	PP	---	X	▲	▲	★	▲	★	★	●
	PP-V0	V-0	X	▲	▲	★	▲	★	★	●
Polyethylene	LDPE	---	X	▲	●	●	▲	★	★	●
	HDPE	---	X	▲	●	●	▲	★	★	●
Polyvinylchloride	Rigid PVC	V-0	●	▲	▲	●	▲	●	●	●
	Soft PVC	---	X	X	▲	▲	▲	●	●	●
Polycarbonate	PC	V-2	X	★	▲~●	★	▲	●	X	▲
Acrylonitrile-Butadiene-Styrene	ABS	HB	X	▲	▲	●	▲	●	●	X
Stainless steel	304 / 316	Nonflammable	★	★	★	★	▲~●	★	●	★

★Excellent / ●Good / ▲ Fair / X Poor

※The above information is for reference only. Because of different substances, concentrations and application, the results will be different. Please refer to actual application.

KSS CABLE TIE FEATURES :

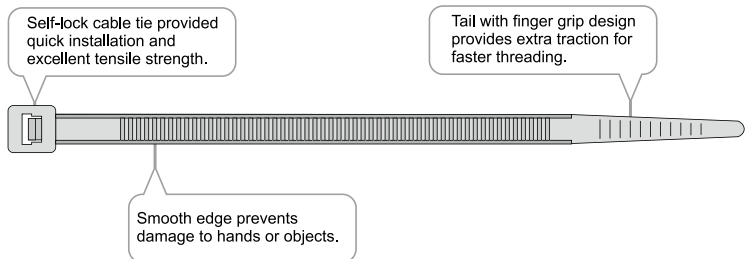

MATERIAL SPECIALITY :

Polyamide 66 (Nylon 66)	STANDARD	<ol style="list-style-type: none"> 1. High water absorption. 2. Good surface lubricity, abrasion resistance. 3. Good mechanical Properties. 4. Good insulation. 5. UL94 Flammability Rating V-2. 6. Good resistance to chemicals, especially for alkali. 7. Compare with nylon 6, nylon 66 has better toughness and better resistance to abrasion, heat and fatigue.
	UV RESISTANCE (Nylon 66-W)	<ol style="list-style-type: none"> 1. High water absorption. 2. Good surface lubricity, abrasion resistance. 3. Good mechanical Properties. 4. Good insulation. 5. UL94 Flammability Rating V-2. 6. Good resistance to chemicals, especially for alkali. 7. Compare with standard nylon 66, nylon 66-W has better UV resistant.
	HEAT STABILIZED (Nylon 66-HS)	<ol style="list-style-type: none"> 1. High water absorption. 2. Good surface lubricity, abrasion resistance. 3. Good mechanical Properties. 4. Good insulation. 5. UL94 Flammability Rating V-2. 6. Good resistance to chemicals, especially for alkali. 7. Compare with standard nylon 66, nylon 66-HS has better high temperature resistant.
	FLAME RETARDANT (Nylon 66-V0)	<ol style="list-style-type: none"> 1. High water absorption. 2. Good surface lubricity, abrasion resistance. 3. Good mechanical Properties. 4. Good insulation. 5. UL94 Flammability Rating V0. 6. Good resistance to chemicals, especially for alkali. 7. Compare with standard nylon 66, nylon 66-V0 has better flammability rating.
Polyamide 6 (Nylon 6)		<ol style="list-style-type: none"> 1. High water absorption. 2. Good surface lubricity, abrasion resistance. 3. Good mechanical Properties. 4. Good insulation. 5. UL94 Flammability Rating HB. 6. Good resistance to chemicals, especially for alkali. 7. Compare to nylon 66, nylon 6 has better softness and better resistance to impact.
Polyamide 12 (Nylon 12)		<ol style="list-style-type: none"> 1. Low water absorption. 2. Good mechanical Properties. 3. Good insulation. 4. UL94 Flammability Rating HB. 5. Good resistance to chemicals, especially for alkali. 7. Good weather resistance for outdoor use.
Polypropylene (PP)		<ol style="list-style-type: none"> 1. Extremely low water absorption. 2. Good mechanical Properties. 3. Good insulation. 4. Good resistance to chemicals, solvents and oils. 5. Compare to PE, PP has better mechanical Properties and better resistance to heat. <p>※PP-V0(flame retardant) available on request.</p>
Polyethylene (PE)		<ol style="list-style-type: none"> 1. Low water absorption. 2. Good insulation. 3. Compare to PP, PE has better softness and better resistance to cold.

ORDERING INFORMATION :

Material		Color	1000pcs	SUFFIX	Item No.	
					100pcs	1000pcs
Nylon 66	STANDARD	Natural	K	--	CV-100	CV-100K
Nylon 66	STANDARD	Black	K	B	CV-120B	CV-120KB
Nylon 66	UV RESISTANCE	Black	K	W	CV-150W	CV-150KW
Nylon 66	HEAT STABILIZED	Light Green	K	HS	CV-190HS	CV-190KHS
Nylon 66	FLAME RESISTANCE	White	K	V0	CV-250V0	CV-250KV0
Nylon 12	WEATHER RESISTANCE	Black	K	N12	CV-280N12	CV-280KN12
PP	STANDARD	Natural		PP	CV-300PP	
PP	STANDARD	Black		PPBK	CV-300PPBK	



0301 KSS NYLON CABLE TIE

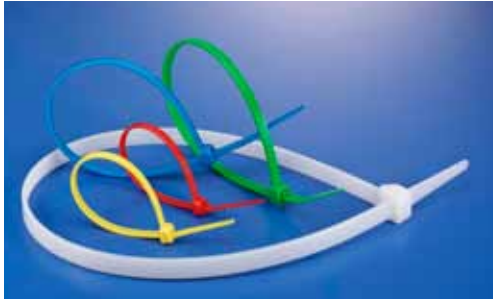

- Material: UL approved Nylon 66, 94V-2, with good tensile strength and insulation, not easy to get aging.
- Color: Standard color is natural, black, other special colors are available upon request.
- Feature: Low Smoke and Hologen Free cable tie suitable for various industry, also household DIY and gardening.
Max. operating temperature up to 85°C
- Application: One piece self-lock cable tie save the time and make effective for installation.

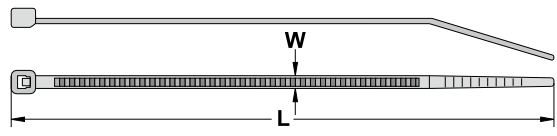

UNIT : mm

Item No.				Length		W	Max.Bundle Dia.	Min LoopTensile Strength		MINIATURE
Natural		Black		mm	inch			lbs	kgs	
100pcs	1000pcs	100pcs	1000pcs							
*CVT-070	CVT-070K	CVT-070B	CVT-070KB	71	2 13/16"	1.6	11	7	3	
*CVT-100	CVT-100K	CVT-100B	CVT-100KB	103	4"	1.95	22	11	5	
CV-060	CV-060K	CV-060B	CV-060KB	63.7	2 1/2"	2.4	11	18	8	
CV-075	CV-075K	CV-075B	CV-075KB	75	3"	2.4	15			
CV-080	CV-080K	CV-080B	CV-080KB	80	3 1/8"	2.5	16			
CV-094	CV-094K	CV-094B	CV-094KB	96	3 3/4"	2.5	21			
CV-100	CV-100K	CV-100B	CV-100KB	100	4"	2.5	22			
CV-120S	CV-120SK	CV-120SB	CV-120SKB	120	4 3/4"	2.5	28			
CV-140S	CV-140SK	CV-140SB	CV-140SKB	142	5 1/2"	2.5	35			
CV-150S	CV-150SK	CV-150SB	CV-150SKB	155	6 1/8"	2.5	39			
CV-165	CV-165K	CV-165B	CV-165KB	165	6 1/2"	2.5	43			
CV-200M	CV-200MK	CV-200MB	CV-200MKB	203	8"	2.5	55			
CV-250S	CV-250SK	CV-250SB	CV-250SKB	250	10"	2.5	68			
CV-300M		CV-300MB		300	11 7/8"	2.5	80			
CV-400S		CV-400SB		400	15 3/4"	2.5	116			
CV-120	CV-120K	CV-120B	CV-120KB	120	4 3/4"	3.2	27	40	18	
CV-140	CV-140K	CV-140B	CV-140KB	142	5 1/2"	3.2	34			
CV-150	CV-150K	CV-150B	CV-150KB	150	6"	3.6	36			
CV-180	CV-180K	CV-180B	CV-180KB	180	7"	3.6	46			
*CV-180T	CV-180TK	CV-180TB	CV-180TKB	180	7"	3.6	46			
CV-200S	CV-200SK	CV-200SB	CV-200SKB	203	8"	3.2	53			
CV-200A	CV-200AK	CV-200AB	CV-200AKB	203	8"	3.6	52			
CV-250M	CV-250MK	CV-250MB	CV-250MKB	250	10"	3.6	68			
CV-265	CV-265K	CV-265B	CV-265KB	265	10 1/2"	3.6	73			
CV-292	CV-292K	CV-292B	CV-292KB	292	11 1/2"	3.6	82			
CV-330		CV-330B		330	13"	3.6	93			
CV-368S		CV-368SB		368	14 1/2"	3.6	105			
CV-120L	CV-120LK	CV-120LB	CV-120LKB	120	4 3/4"	4.8	27	50	22	
CV-160L	CV-160LK	CV-160LB	CV-160LKB	160	6 1/4"	4.8	39			
CV-190	CV-190K	CV-190B	CV-190KB	190	7 1/2"	4.8	49			
*CV-190T	CV-190TK	CV-190TB	CV-190TKB	190	7 1/2"	4.8	49			
CV-200	CV-200K	CV-200B	CV-200KB	203	8"	4.6	52			
CV-200D	CV-200DK	CV-200DB	CV-200DKB	203	8"	4.8	52			

* CVT-070 doesn't have minimum bundle diameter. * CV-200T Tail * CV-180T Tail CV-190T

Item No.				Length		W	Max.Bundle Dia.	Min LoopTensile Strength	
Natural		Black		mm	inch			lbs	kgs
100pcs	1000pcs	100pcs	1000pcs						
※CV-200T	CV-200TK	CV-200TB	CV-200TKB	203	8"	4.6	52	50	22
CV-250	CV-250K	CV-250B	CV-250KB	250	10"	4.8	68		
CV-280	CV-280K	CV-280B	CV-280KB	280	11"	4.8	77		
CV-300S		CV-300SB		300	11 7/8"	4.8	83		
CV-310		CV-310B		310	12"	4.8	86		
NEW CV-350		CV-350B		350	13 3/4"	4.6	98		
CV-368		CV-368B		368	14 1/2"	4.8	105		
CV-385		CV-385B		385	15 3/16"	4.8	110		
NEW CV-400		CV-400B		400	15 3/4"	4.6	116		
CV-432		CV-432B		432	17"	4.8	125		
CV-450M		CV-450MB		450	17 3/4"	4.8	131		
CV-500		CV-500B		500	19 11/16"	4.8	147		
CV-550S		CV-550SB		550	21 11/16"	4.8	162		
CV-610S		CV-610SB		610	24"	4.8	181		
CV-635S		CV-635SB		635	25"	4.8	189		
NEW CV-730S		CV-730SB		730	28 3/4"	4.8	219		
CV-914S		CV-914SB		914	36"	4.8	278		
CV-380S		CV-380SB		380	15"	6.4	108		
CV-750		CV-750B		750	29 1/2"	7.5	223	120	55
CV-120LL	CV-120LLK	CV-120LLB	CV-120LLKB	120	4 3/4"	7.6	22		
CV-150L	CV-150LK	CV-150LB	CV-150LKB	150	6"	7.6	32		
CV-200L	CV-200LK	CV-200LB	CV-200LKB	203	8"	7.6	52		
CV-240L	CV-240LK	CV-240LB	CV-240LKB	240	9 7/16"	7.6	61		
NEW CV-250L		CV-250LB		250	10"	7.6	64		
CV-280L	CV-280LK	CV-280LB	CV-280LKB	280	11"	7.6	74		
CV-300		CV-300B		300	11 7/8"	7.6	80		
CV-340		CV-340B		340	13 1/2"	7.6	92		
CV-360		CV-360B		360	14 3/16"	7.6	99		
CV-370		CV-370B		370	14 9/16"	7.6	101		
CV-380		CV-380B		380	15"	7.6	105		
NEW CV-610M		CV-610MB		610	24"	7.6	177		
CV-380L		CV-380LB		380	15"	8.0	105		
CV-450		CV-450B		450	17 3/4"	8.0	128		
CV-500L		CV-500LB		500	19 11/16"	8.0	143		
CV-550		CV-550B		550	21 11/16"	8.0	160		
CV-450L		CV-450LB		450	17 3/4"	9.0	128		
CV-550D		CV-550DB		550	21 11/16"	9.0	160		
CV-610		CV-610B		610	24"	9.0	177		
CV-685		CV-685B		685	27"	9.0	202		
CV-710		CV-710B		710	28"	9.0	209		
CV-762		CV-762B		762	30"	9.0	227		
CV-812		CV-812B		812	32"	9.0	243		
CV-914		CV-914B		914	36"	9.0	275		
CV-940		CV-940B		940	37"	9.0	284		
CV-1168		CV-1168B		1168	46"	9.0	356		
CV-1219		CV-1219B		1219	48"	9.0	372		
CV-1500		CV-1500B		1500	59"	9.0	462		
CV-550L		CV-550LB		550	21 11/16"	12.7	159	250	114

STANDARD

HEAVY DUTY

0301 KSS METAL DETECTABLE NYLON CABLE TIE



NEW

- Material: NYLON 66 with metal powder, flammability 94-HB
- Color: Blue, Special color upon request.
- Application: One piece self-lock cable tie for quick installation.
- Feature: Apply for Food and Medical industrial, FDA standard, can be detected by Metal sensor.

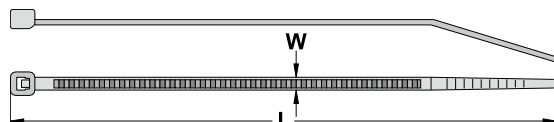

UNIT : mm

Item No.	L		W	Max.Bundle Dia.	Min LoopTensile Strength		Packing
	mm	inch			lbs	kgs	
CV-150MD	150	6"	3.6	36	25	11	100pcs
CV-200MD	203	8"	4.6	52	34	15	
CV-200MMD	203	8"	2.5	55	14	6	
CV-250MD	250	10"	4.8	68	34	15	
CV-280MD	280	11"	4.8	77	34	15	
CV-380MD	380	15"	7.6	105	88	39	
CV-385MD	385	15 3/16"	4.8	110	34	15	
CV-400MD	400	15 3/4"	4.6	116	34	15	

0301 KSS NYLON CABLE TIE (FLAME RETARDANT)



UNIT : mm



Item No.	L		W	Max.Bundle Dia.	Min LoopTensile Strength		Packing
	mm	inch			lbs	kgs	
CV-100V0	100	4"	2.5	22	18	8	100pcs
CV-150V0	150	6"	3.6	36	40	18	
CV-200MV0	203	8"	2.5	55	18	8	
CV-200V0	203	8"	4.6	52	50	22	
CV-300SV0	300	11 7/8"	4.8	83	50	22	
CV-368V0	368	14 1/2"	4.8	105	50	22	
CV-380V0	380	15"	7.6	105	120	55	

- Material: UL approved Nylon 66, 94V-0, anti-aging and strong bearing
- Color: Natural (standard), black color or other colors available
- Feature : 94V-0 Flame Retardant

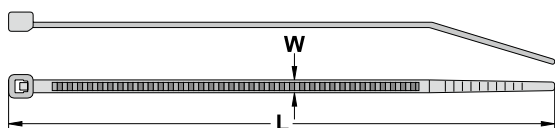

0301 KSS HEAT STABILIZED NYLON CABLE TIE



- Material: UL approved Nylon 66, 94V-2, anti-aging and strong bearing
- Color: Light green (standard), black color or other colors available
- Feature : Designed for high-temperature up to 105°C.

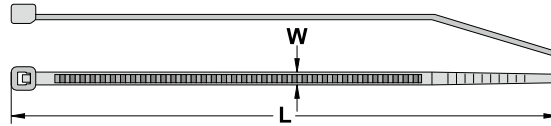

UNIT : mm

Item No.		L		W	Max.Bundle Dia.	Min LoopTensile Strength		Packing
Light green (standard)	Black	mm	inch			lbs	kgs	
CV-100HS	CV-100HSBK	100	4"	2.5	22	18	8	100pcs
CV-140SHS	CV-140SHSBK	142	5 1/2"	2.5	35	18	8	
CV-150HS	CV-150HSBK	150	6"	3.6	36	40	18	
CV-200MHS	CV-200MHSBK	203	8"	2.5	55	18	8	
CV-200HS	CV-200HSBK	203	8"	4.6	52	50	22	
CV-250HS	CV-250HSBK	250	10"	4.8	68	50	22	
CV-300SHS	CV-300SHSBK	300	11 7/8"	4.8	83	50	22	
CV-300HS	CV-300HSBK	300	11 7/8"	7.6	80	120	55	
CV-368HS	CV-368HSBK	368	14 1/2"	4.8	105	50	22	
CV-380HS	CV-380HSBK	380	15"	7.6	105	120	55	

0301 KSS POLYPROPYLENE CABLE TIE



UNIT : mm

Item No.	L		W	Max.Bundle Dia.	Min LoopTensile Strength		Packing
	mm	inch			lbs	kgs	
CV-150PPBK	150	6"	3.6	36	18	8	100pcs
CV-200PPBK	200	8"	4.6	52	22	10	
CV-240LPPBK	240	9 7/16"	7.6	61	51	23	
CV-250PPBK	250	10"	4.8	68	22	10	
CV-300PPBK	300	11 7/8"	7.6	80	51	23	
CV-380PPBK	380	15"	7.6	105	51	23	
CV-550PPBK	550	21 11/16"	8.0	160	51	23	

- Material: PP, good at chemical resistance from different density of base and acid.
- Color: Black (Natural is also available)
- Function: For fixing cable used at chemical industry. Increase the durability of cable tie application in chemical circumstance.

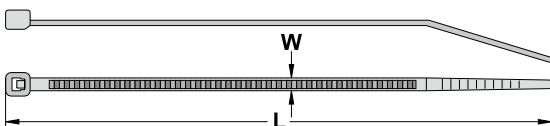



0301 KSS UV RESISTANT NYLON CABLE TIE



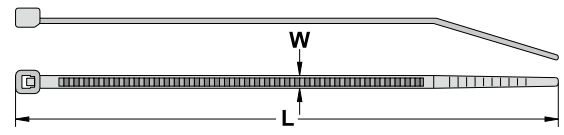

- Carbon black added for greater resistance to ultra violet in outdoor usage.
- Prolongs useful life of cable tie under sunshine/outdoor application.
- UV resistant cable tie: for outdoor use with UV feature.
- ※ Please make an inquiry for different environment purpose.

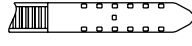

UNIT : mm

Item No.		Length		W	Max.Bundle Dia.	Min LoopTensile Strength		
100pcs	1000pcs	mm	inch			lbs	kgs	
※CVT-070W	CVT-070KW	71	2 13/16"	1.6	16	7	3	MINIATURE
※CVT-100W	CVT-100KW	103	4"	1.95	22	11	5	
CV-060W	CV-060KW	63.7	2 1/2"	2.4	11	18	8	
CV-075W	CV-075KW	75	3"	2.4	15			
CV-080W	CV-080KW	80	3 1/8"	2.5	16			
CV-094W	CV-094KW	96	3 3/4"	2.5	21			
CV-100W	CV-100KW	100	4"	2.5	22			
CV-120SW	CV-120SKW	120	4 3/4"	2.5	28			
CV-140SW	CV-140SKW	142	5 1/2"	2.5	35			
CV-150SW	CV-150SKW	155	6 1/8"	2.5	39			
CV-165W	CV-165KW	165	6 1/2"	2.5	43			
CV-200MW	CV-200MKW	203	8"	2.5	55			
CV-250SW	CV-250SKW	250	10"	2.5	68			
CV-300MW		300	11 7/8"	2.5	80			
CV-400SW		400	15 3/4"	2.5	116			
CV-120W	CV-120KW	120	4 3/4"	3.2	27	40	18	INTERMEDIATE
CV-140W	CV-140KW	142	5 1/2"	3.2	34			
CV-150W	CV-150KW	150	6"	3.6	36			
CV-180W	CV-180KW	180	7"	3.6	46			
※CV-180TW	CV-180TKW	180	7"	3.6	46			
CV-200SW	CV-200SKW	203	8"	3.2	53			
CV-200AW	CV-200AKW	203	8"	3.6	52			
CV-250MW	CV-250MKW	250	10"	3.6	68			
CV-265W	CV-265KW	265	10 1/2"	3.6	73			
CV-292W	CV-292KW	292	11 1/2"	3.6	82			
CV-330W		330	13"	3.6	93			
CV-368SW		368	14 1/2"	3.6	105			
CV-120LW	CV-120LKW	120	4 3/4"	4.8	27	50	22	STANDARD
CV-160LW	CV-160LKW	160	6 1/4"	4.8	39			
CV-190W	CV-190KW	190	7 1/2"	4.8	49			
※CV-190TW	CV-190TKW	190	7 1/2"	4.8	49			
CV-200W	CV-200KW	203	8"	4.6	52			
CV-200DW	CV-200DKW	203	8"	4.8	52			
※CV-200TW	CV-200TKW	203	8"	4.6	52			
CV-250W	CV-250KW	250	10"	4.8	68			
CV-280W	CV-280KW	280	11"	4.8	77			
CV-300SW		300	11 7/8"	4.8	83			
CV-310W		310	12"	4.8	86			

※ CVT-070W doesn't have minimum bundle diameter. ※ CV-200TW Tail CVT-100W  ※ CV-180TW Tail CV-190TW 

Item No.		Length		W	Max.Bundle Dia.	Min LoopTensile Strength				
100pcs	1000pcs	mm	inch			lbs	kgs			
NEW	CV-350W		350	13 3/4"	4.6	98	50	22		
	CV-368W		368	14 1/2"	4.8	105				
	CV-385W		385	15 3/16"	4.8	110				
NEW	CV-400W		400	15 3/4"	4.6	116				
	CV-432W		432	17"	4.8	125				
	CV-450MW		450	17 3/4"	4.8	131				
	CV-500W		500	19 11/16"	4.8	147				
	CV-550SW		550	21 11/16"	4.8	162				
	CV-610SW		610	24"	4.8	181				
	CV-635SW		635	25"	4.8	189				
NEW	CV-730SW		730	28 3/4"	4.8	219				
	CV-914SW		914	36"	4.8	278				
	CV-380SW		380	15"	6.4	108			100	45
	CV-750W		750	29 1/2"	7.5	223			120	55
	CV-120LLW	CV-120LLKW	120	4 3/4"	7.6	22				
	CV-150LW	CV-150LKW	150	6"	7.6	32				
	CV-200LW	CV-200LKW	203	8"	7.6	52				
	CV-240LW	CV-240LKW	240	9 7/16"	7.6	61				
NEW	CV-250LW		250	10"	7.6	64				
	CV-280LW	CV-280LKW	280	11"	7.6	74				
	CV-300W		300	11 7/8"	7.6	80				
	CV-340W		340	13 1/2"	7.6	92				
	CV-360W		360	14 3/16"	7.6	99				
	CV-370W		370	14 9/16"	7.6	101				
	CV-380W		380	15"	7.6	105				
NEW	CV-610MW		610	24"	7.6	177				
	CV-380LW		380	15"	8.0	105				
	CV-450W		450	17 3/4"	8.0	128				
	CV-500LW		500	19 11/16"	8.0	143				
	CV-550W		550	21 11/16"	8.0	160				
	CV-450LW		450	17 3/4"	9.0	128	175	80		
	CV-550DW		550	21 11/16"	9.0	160				
	CV-610W		610	24"	9.0	177				
	CV-685W		685	27"	9.0	202				
	CV-710W		710	28"	9.0	209				
	CV-762W		762	30"	9.0	227				
	CV-812W		812	32"	9.0	243				
	CV-914W		914	36"	9.0	275				
	CV-940W		940	37"	9.0	284				
	CV-1168W		1168	46"	9.0	356				
	CV-1219W		1219	48"	9.0	372				
	CV-1500W		1500	59"	9.0	462				
	CV-550LW		550	21 11/16"	12.7	159	250	114		

STANDARD
HEAVY DUTY

0301 KSS NYLON CABLE TIE



HVAC Duct Straps

UL 181B-C for use with UL non-metallic air ducts and air connectors.
Recommended for use with R-6 and R-8 flex duct.

UNIT : mm

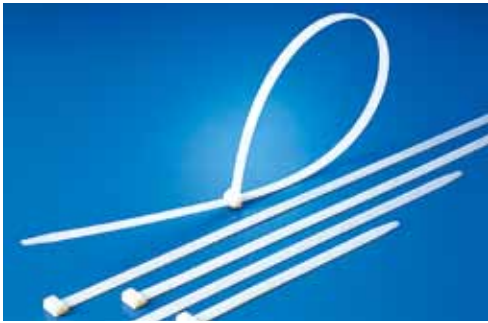

Item No.			L		W	Max.Bundle Dia.	Min Loop Tensile Strength	
Natural	Black	Weather Resistant	mm	inch			lbs	kgs
100pcs	100pcs	100pcs						
CV-914	CV-914B	CV-914W	914	36"	9	275	175	80
CV-940	CV-940B	CV-940W	940	37"	9	284		
CV-1219	CV-1219B	CV-1219W	1219	48"	9	372		

- Material: UL approved Nylon 66, 94V-2, with good tensile strength and insulation, not easy to get aging.
- Color: Standard color is natural, black, other special colors are available upon request.
- Feature: Low Smoke and Hologen Free cable tie suitable for various industry, also household DIY and gardening.
Max. operating temperature up to 85°C
- Application: One piece self-lock cable tie save the time and make effective for installation.

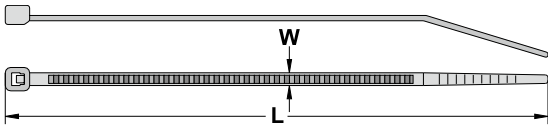

0301 KSS NYLON CABLE TIE

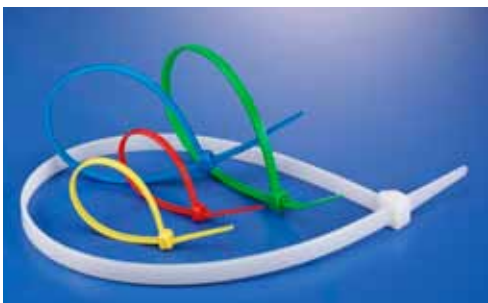

- Material: UL approved Nylon 66, 94V-2, with good tensile strength and insulation, not easy to get aging.
- Color: Standard color is natural, black, other special colors are available upon request.
- Feature: Low Smoke and Halogen Free cable tie suitable for various industry, also household DIY and gardening.
Max. operating temperature up to 85°C
- Application: One piece self-lock cable tie save the time and make effective for installation.

▲ STANDARD

UNIT : mm

Item No.				Length		W	Max.Bundle Dia.	Min Loop Tensile Strength	
Natural		Black		mm	inch			lbs	kgs
100pcs	1000pcs	100pcs	1000pcs						
CV-200Z	CV-200ZK	CV-200ZB	CV-200ZKB	200	8"	4.6	48	75	34
CV-280Z	CV-280ZK	CV-280ZB	CV-280ZKB	280	11"	4.8	70		
CV-300SZ		CV-300SZB		300	11 7/8"	4.8	74		
CV-368Z		CV-368ZB		368	14 1/2"	4.8	94		
※CV-300STZ		CV-300STZB		300	11 7/8"	4.8	83	80	36

STANDARD

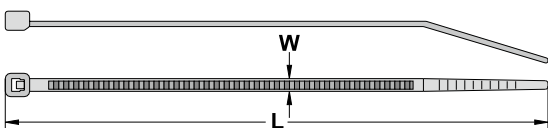

0301 KSS UV RESISTANT NYLON CABLE TIE



- Carbon black added for greater resistance to ultra violet in outdoor usage.
- Prolongs useful life of cable tie under sunshine/outdoor application.
- UV resistant cable tie: for outdoor use with UV feature.
- ※ Please make an inquiry for different environment purpose.
- ▲ STANDARD

UNIT : mm

Item No.		Length		W	Max.Bundle Dia.	Min LoopTensile Strength		STANDARD
100pcs	1000pcs	mm	inch			lbs	kgs	
CV-200ZW	CV-200ZKW	200	8"	4.6	48	75	34	
CV-280ZW	CV-280ZKW	280	11"	4.8	70			
CV-300SZW		300	11 7/8"	4.8	74			
CV-368ZW		368	14 1/2"	4.8	94			
※CV-300STZW		300	11 7/8"	4.8	83	80	36	

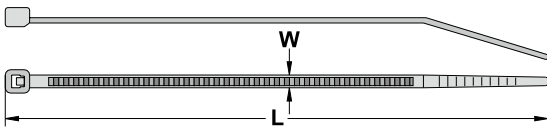

0301 KSS EXTRA HEAVY DUTY TIE



- Material: UL approved Nylon 66, 94V-2, With good tensile strength and insulation, not easy to get aging.
- Extra heavy duty ties for application where higher tensile strength is needed.

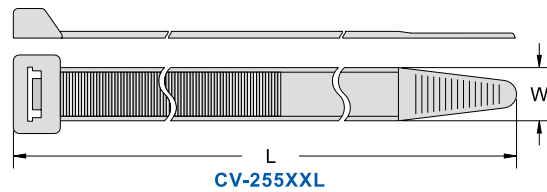
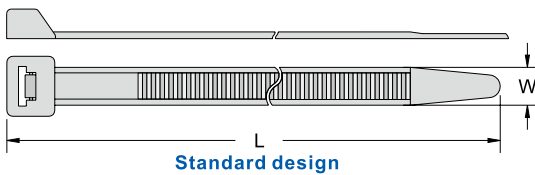

UNIT : mm

Item No.	Length		W	Max.Bundle Dia.	Min LoopTensile Strength		Packing	EXTRA HEAVY DUTY
	mm	inch			lbs	kgs		
CV-230XL	230	9"	12.7	57	250	114	100 pcs	
CV-255XXL	254	10"	17.8	42	120	55		
CV-280XL	280	11"	12.7	73	250	114		
CV-380XL	380	15"	12.7	105	250	114		
CV-480XL	480	18 7/8"	12.7	137	250	114		
CV-550L	550	21 11/16"	12.7	159	250	114		
CV-580XL	580	22 7/8"	12.7	169	250	114		
CV-730XL	730	28 3/4"	12.7	216	250	114		
CV-880XL	880	34 11/16"	12.7	264	250	114		
CV-1030XL	1030	40 1/2"	12.7	312	250	114		
NEW ※CV-1530XLT	1530	60 1/4"	12.7	473	250	114		



0302 KSS TIE GUN



- Economical, pocket type
- Twist to cut surplus tie end after tightening cable. (TG-6)
- Tie gun for stainless steel tie. (TG-20, TG-21)

UNIT : mm

Item No.	Feature	For Tie Width	Weight
TG-3	Automatically cutting when tightens up. Quickly tightens and cuts cable tie tail for one step application. Excellent for industrial assembly.	2.2~4.8	300 g
TG-5	Automatically cutting when tightens up. Quickly tightens and cuts cable tie tail for one step application. Excellent for industrial assembly.	2.2~4.8	333 g
TG-6	Twist tie gun after tighten to cut off cable tie tail manually.	2.5~5.0	60 g
TG-7	Automatically cutting when tightens up. Quickly tightens and cuts cable tie tail for one step application. Excellent for industrial assembly.	2.5~5.0	275 g
TG-9	Pull the handle to tighten up cable tie. Press to cut off the tail. Designed for cable tie above 5.0mm width.	2.5~10.0	275 g
TG-10	Automatically cutting when tightens up. Quickly tightens and cuts cable tie tail for one step application. Excellent for industrial assembly.	4.8~13.0	320 g
NEW TG-20	Suitable for stainless steel cable tie. Automatically cutting when tightens up. Quickly tightens and cuts cable tie tail for one step application. Excellent for industrial assembly.	4.5~7.9	554 g
TG-21	Suitable for stainless steel cable tie. Pull the handle to tighten up cable tie. Press to cut off the tail.	4.6~7.9	556 g

0305 KSS MOUNTING CABLE TIE



UNIT : mm



Item No.	Length		W	A	Max. Bundle Dia.	Min Loop Tensile Strength		Packing
	mm	inch				lbs	kgs	
TCV-100	110	4 3/8"	2.5	3.2	25	18	8	100 pcs
TCV-155	171.5	6 11/16"	3.7	5.0	40	40	18	
TCVS-170	171	6 11/16"	3.7	4.0	40	40	18	
TCV-205	219	8 11/16"	4.2	5.0	52	50	22	
TCV-300	300	11 7/8"	4.8	4.8	85	50	22	
TCV-300L	300	12 1/2"	7.8	6.0	80	120	55	
TCV-370	370	14 1/2"	4.8	4.8	102	50	22	
TCV-400	400	15 3/4"	7.9	6.0	112	120	55	
NEW TCV-205DZ	219	8 11/16"	4.8	5.0	52	75	34	100 pcs

- Material: UL approved Nylon 66, 94V-2
- Color: Natural (for black. Please add "BK" to Item no.)
- The cable tie can be secured to panel with a single bolt

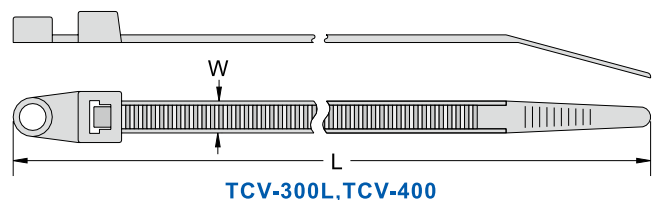
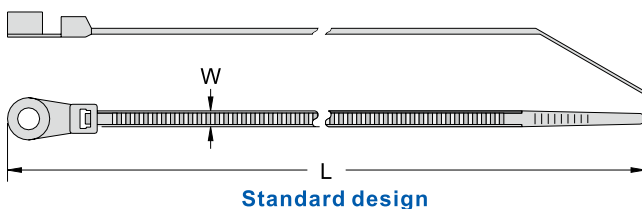

0309 KSS DOUBLE HEAD CABLE TIE (UNRELEASABLE)



UNIT : mm



Item No.	Length		W	D1		D2		Min Loop Tensile Strength		Packing
	mm	inch		MAX.	MIN.	MAX.	MIN.	lbs	kgs	
DCV-225	225	8 7/8"	4.8	59	2.5	52	2	50	22	100 pcs
DCV-300	300	11 7/8"	4.8	83	2.5	76	2	50	22	
DCV-370	370	14 9/16"	4.8	105	2.5	98	2	50	22	

- Material: UL approved Nylon 66, 94V-2
- Color: Natural
- Feature: Double head design, only one tie is needed to bundle two objects.

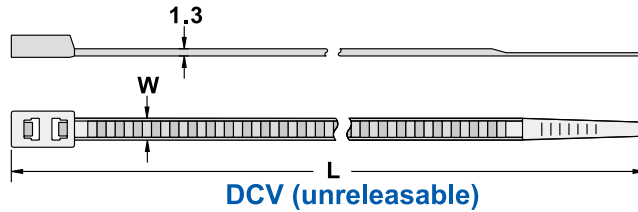
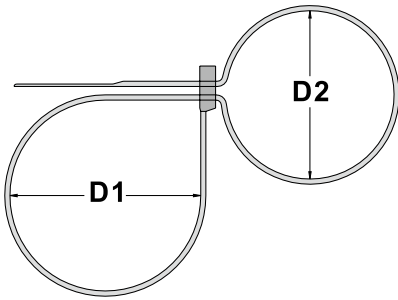

0309 KSS DOUBLE HEAD CABLE TIE (RELEASABLE)



UNIT : mm



Item No.	Length		W	D1		D2		Min Loop Tensile Strength		Packing
	mm	inch		MAX.	MIN.	MAX.	MIN.	lbs	kgs	
RDCV-225	225	8 7/8"	4.8	59	2.5	52	2	50	22	100 pcs
RDCV-300	300	11 7/8"	4.8	83	2.5	76	2	50	22	
RDCV-370	370	14 9/16"	4.8	105	2.5	98	2	50	22	

- Material: UL approved Nylon 66, 94V-2
- Color: Natural
- Feature: 1. Double head design, only one tie is needed to bundle two objects.
2. One of the heads possesses the release design.

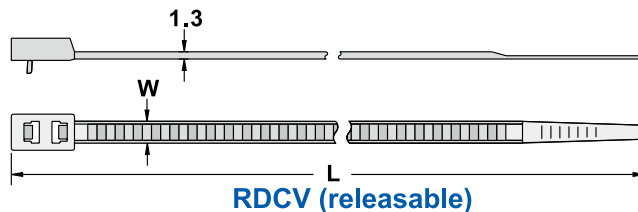
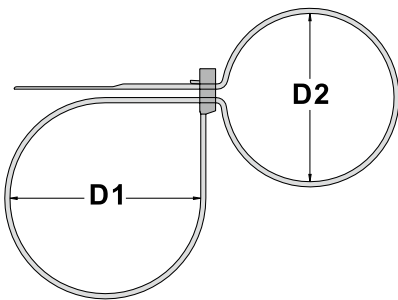

0309 KSS HANDCUFF TIE



UNIT : mm

NEW



PATENT



(This Value Pack item No. is VP-10-35NBE)

Item No.	L		L1		W	Max.Bundle Dia.	Min LoopTensile Strength		Packing
	mm	inch	mm	inch			lbs	kgs	
DV-900NBE	900	35 1/2"	450	17 3/4"	8.0	127	120	55	10pcs

- Material: UL approved Nylon 66, 94V-2, with good tensile strength and insulation, not easy to age.
 - Color: Blue
 - Function: By means of double lock, bind wires or restrict action immediately.
 - Feature: TAIWAN EXCELLENCE 2017 awarded product.
 1. Bundling two things with single tie.
 2. Lock with extra height is hard to break.
 3. Smooth is inside so it won't hurt hands or wires.
 4. Environmental friendly, wear and impact resistant, easy to carry.
- ※ Special color, length, design, package available on request.

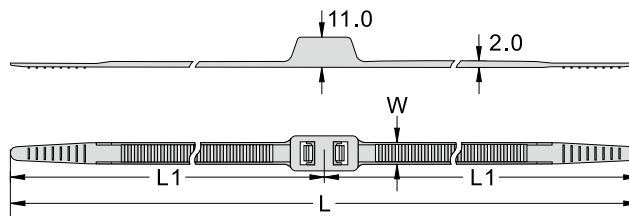

0310 KSS BEAD TIE



UNIT : mm



Item No.	Length		W	Max.Bundle Dia.	Min LoopTensile Strength		Packing
	mm	inch			lbs	kgs	
TV-130K	143	5 3/8"	1.8	35	11	5	1000pcs

- Material: UL approved Nylon 66, 94V-2
- Color: Natural
- Feature: To secure fire extinguisher pull pin and used as clothing tag tie.

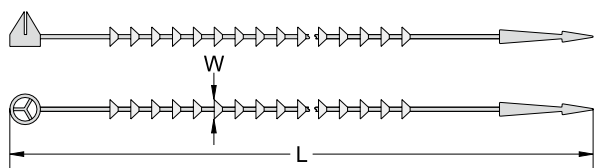

0312 KSS RELEASABLE MARKER TIE



UNIT : mm

NEW
PATENT

Item No.	Length		W	Max.Bundle Dia.	Min LoopTensile Strength		Marking pad A X B	Packing
	mm	inch			lbs	kgs		
MHVC-100	114	4 1/2"	3.6	24	18	8	13 x19	100PCS
MHVC-200	215	8 1/2"	3.6	50	18	8	13 x19	

- Material: UL approved Nylon 66, 94V-2
- Color: Natural
- Tie and identify bundles of cable in one operation.Flat areas may be imprinted or written on with a Marking Pen.
- Easily assembled by hand or with pliers, remain securely locked until intentionally released by operating the finger catch.

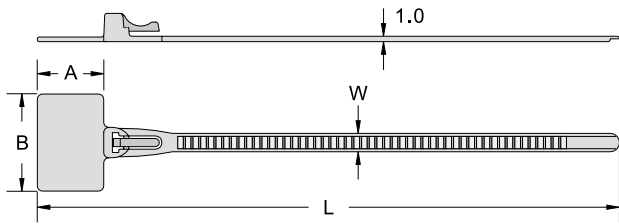

0312 KSS MARKER TIE



UNIT : mm



Item No.	Length		W	Max.Bundle Dia.	Min LoopTensile Strength		Marking pad A X B	Packing
	mm	inch			lbs	kgs		
MCV-100	100	4"	2.5	23	18	8	8 X 25	100 pcs
MCV-100L	130	5 1/8"	2.5	22	18	8	28X 20	
MCV-110	110	4 3/8"	2.5	20	18	8	8 X 25	
MCV-200	200	8"	4.6	50	50	22	28 X 13	
MCV-200S	200	8"	2.5	50	18	8	15 X 30	
MCV-200SS	200	8"	2.5	50	18	8	8 X 25	
MCV-270	270	11"	4.6	75	50	22	28 X 13	
MCV-300	300	11 7/8"	4.8	82	50	22	54.5 X 13	
MCV-370	370	14 9/16"	4.8	105	50	22	54.5 X 13	

- Material: UL approved Nylon 66, 94V-2
- Tie and identify bundles of cable in one operation.Flat areas may be imprinted or written on with a Marking Pen.

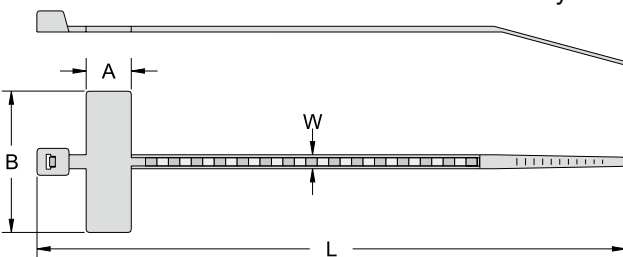
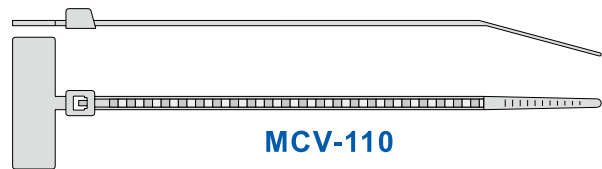
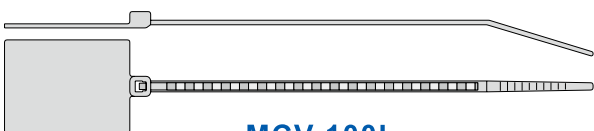
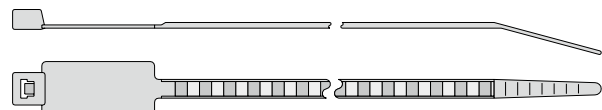
**MCV-100, MCV-200S
MCV-200SS**

MCV-110

MCV-100L

**MCV-200, MCV-270
MCV-300, MCV-370**

0313 KSS SECURITY MARKER TIE



UNIT : mm



Item No.	Length		W	Max.Bundle Dia.	Marking pad A X B	Packing
	mm	inch				
SCT-110	111	4 3/8"	2.6	20	8 X 27.6	100 pcs
SCT-250	248.5	10"	3.5	50	36 X 19	
SCT-400	400	15 3/4"	4.8	102	36.5 X 19	

- Material: UL approved Nylon 66, 94V-2
- Feature: for the purpose of identification for security service logistics, transportation and courier.

The size of marker plate could be made or carved LOGO upon customer's request.

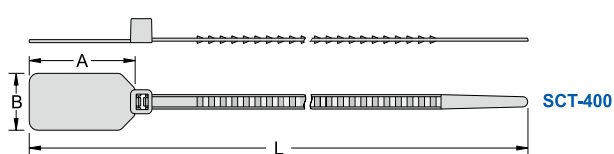
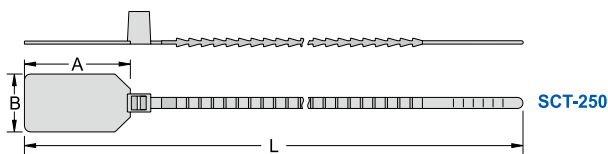
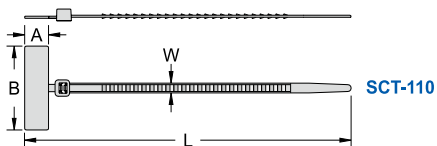

0314 KSS MARKER TIE



UNIT : mm



Item No.	Length		W	Max.Bundle Dia.	Marking pad	Packing
	mm	inch				
PMT-150	160	6 1/4"	5.0	25	9.2 X 30	100pcs

- Material : PE
- Color: Natural
- Put the marking paper chip into marker box.

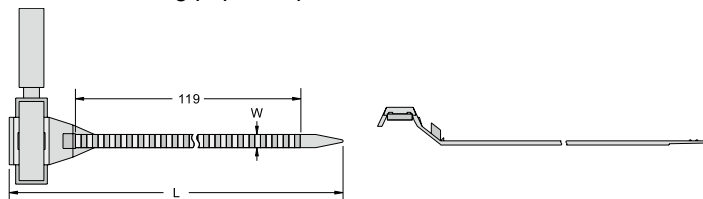

0315 KSS EASY RELEASABLE CABLE TIE



UNIT : mm



Item No.	Length		W	Max.Bundle Dia.	Min Loop Tensile Strength		Packing
	mm	inch			lbs	kgs	
	HB-200BK	218			8 9/16"	7.5	

- Material: UL approved Nylon 66, 94V-2
- Color: Black.
- Feature: TAIWAN EXCELLENCE 2019 awarded product.
 - 1.Head design provides simple and easy to open the strap with a finger.
 - 2.Outside serrated design helps to protect the wires/cables.
 - 3.Releasable and reusable.



PATENT

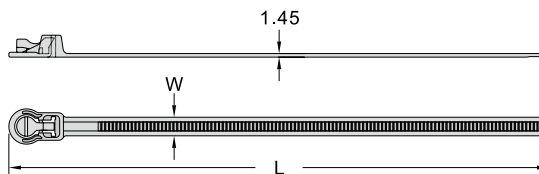

TAIWAN EXCELLENCE 2019 awarded product
(This Value Pack item No. is PHB-200BK-10)

0315 KSS RELEASABLE CABLE TIE



UNIT : mm



Item No.		Length		W	Max.Bundle Dia.	Min LoopTensile Strength		Packing
Black	Natural	mm	inch			lbs	kgs	
HV-125BK	HV-125	125	4 15/16"	7.6	30	50	22	100 pcs
HV-150BK	HV-150	150	6"	7.6	35	50	22	
HV-200BK	HV-200	203	8"	7.6	50	50	22	
HV-250BK	HV-250	250	10"	7.6	65	50	22	
HV-300BK	HV-300	300	11 7/8"	7.6	80	50	22	
HV-500BK		500	19 11/16"	8.5	145	75	34	

- Material: UL approved Nylon 66, 94V-2
- Color: Black , Natural
- Easily assembled by hand or with pliers, remain securely locked until intentionally released by operating the finger catch.

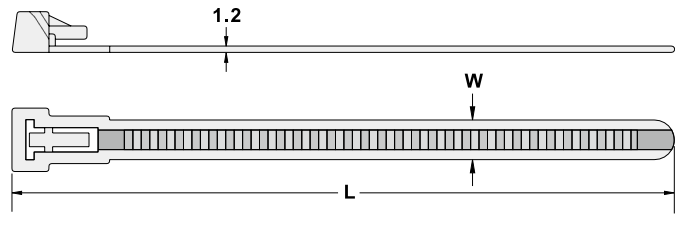

0315 KSS RELEASABLE CABLE TIE



UNIT : mm



Item No.		Length		W	Max.Bundle Dia.	Min LoopTensile Strength		Packing
Black	Natural	mm	inch			lbs	kgs	
HV-125SBK	HV-125S	125	4 15/16"	4.5	25	50	22	100 pcs
HV-150SBK	HV-150S	150	6"	4.5	35	50	22	
HV-200SBK	HV-200S	200	8"	4.5	50	50	22	
HV-250SBK	HV-250S	250	10"	4.5	65	50	22	
HV-300SBK	HV-300S	300	11 7/8"	4.5	80	50	22	

- Material: UL approved Nylon 66, 94V-2
- Color: Black , Natural
- Feature:TAIWAN EXCELLENCE 2019 awarded product.
 1. Special lock design makes good tensile strength.
 2. Sharp tail for easy installation.
 3. Releasable and reusable.



TAIWAN EXCELLENCE 2019 awarded product
(This Value Pack item No. is PC-12-HV150S)

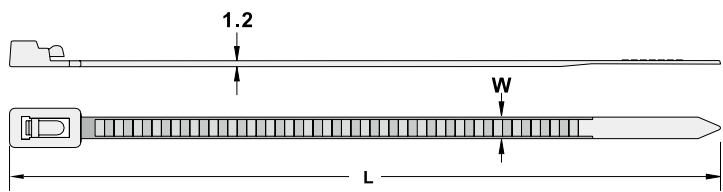

0315 KSS RELEASABLE CABLE TIE



UNIT : mm



Item No.		Length		W	Max.Bundle Dia.	Min LoopTensile Strength		Packing
Black	Natural	mm	inch			lbs	kgs	
HVC-125BK	HVC-125	125	4 15/16"	7.6	30	50	22	100 pcs
HVC-150BK	HVC-150	152	6"	7.6	41	50	22	
HVC-200BK	HVC-200	203	8"	7.6	58	50	22	
HVC-250BK	HVC-250	253	10"	7.6	73	50	22	
HVC-300BK	HVC-300	303	11 7/8"	7.6	89	50	22	
HVC-370BK	HVC-370	370	14 5/8"	7.6	108	50	22	

- Material: UL approved Nylon 66, 94V-2
- Color: Black , Natural
- Easily assembled by hand or with pliers, remain securely locked until intentionally released by operating the finger catch.

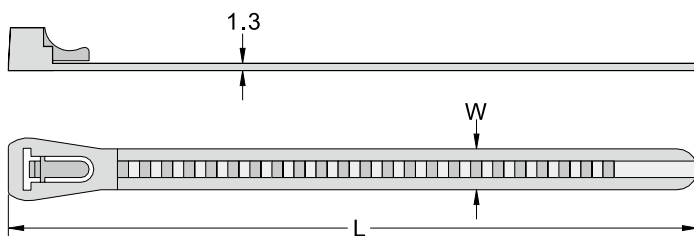

0316 KSS RELEASABLE CABLE TIE



UNIT : mm



Item No.	Length		W	Max.Bundle Dia.	Min LoopTensile Strength		Packing
	mm	inch			lbs	kgs	
RCV-100	102	4"	3.6	25	40	18	100 pcs
RCV-150	150	6"	4.6	39	50	22	
RCV-200	200	8"	4.6	55	50	22	
RCV-250	250	10"	4.8	74	50	22	
RCV-300	300	11 7/8"	4.8	88	50	22	
RCV-370	370	14 9/16"	4.8	102	50	22	
NEW RCV-780T	780	30 3/4"	9.0	230	175	80	
NEW RCV-914	914	36"	9.0	275	175	80	
RCV-230XL	232.5	8 15/16"	12.8	60	250	114	
RCV-290XL	292.5	11 1/2"	12.8	79	250	114	
RCV-405XL	407.5	16"	12.8	116	250	114	
RCV-480XL	482.5	18 7/8"	12.8	140	250	114	
RCV-580XL	576.6	22 7/8"	12.8	172	250	114	

- Material: UL approved Nylon 66, 94V-2
- Finger catch design to release cable tie locking. Idea for temporary fastening purpose.

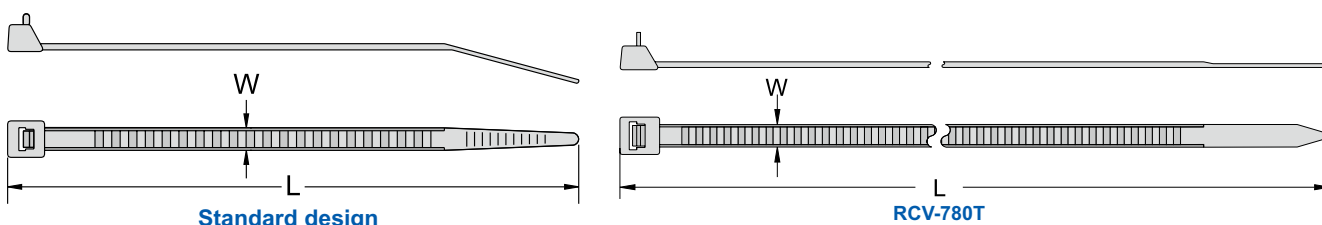

0316 KSS RELEASABLE LASHING CABLE TIE



UNIT : mm

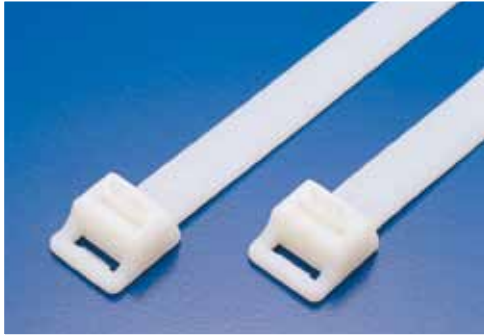

Item No.	Length		W	Max.Bundle Dia.	Min LoopTensile Strength		Packing
	mm	inch			lbs	kgs	
HRCV-240XL	240	9 7/16"	12.8	60	250	114	100 pcs
HRCV-300XL	300	11 7/8"	12.8	79	250	114	
HRCV-415XL	415	16 5/16"	12.8	116	250	114	
HRCV-490XL	490	19 5/16"	12.8	140	250	114	
HRCV-590XL	590	23 1/4"	12.8	170	250	114	

- Material: UL approved Nylon 66, 94V-2
- Finger catch design to release cable tie locking. Idea for temporary fastening purpose.

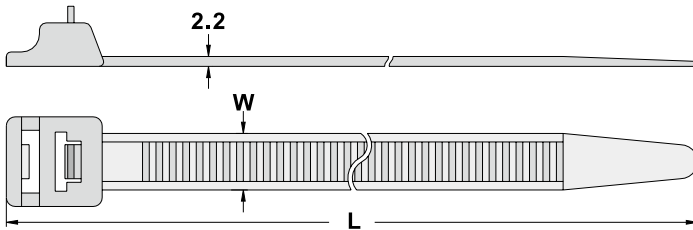

0318 KSS PUSH MOUNT COLLECT TIE



UNIT : mm



Item No.	Length		W	Max.Bundle Dia.	Min LoopTensile Strength		Packing
	mm	inch			lbs	kgs	
PHV-150	152.5	6"	7.9	37	30	13	100pcs

- Material: UL approved Nylon 66, 94V-2
- Application: Drill a 5.4mm diameter round hole near electrical outlet and fix cables to the panel board.
- Function: Suitable for cable binding and fixing on industrial and home electronics.
- Feature: Releasable.

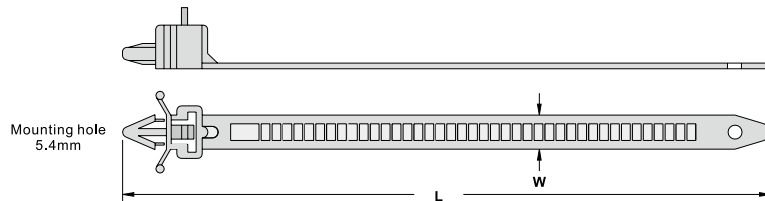
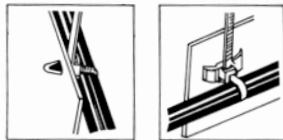

0319 KSS SADDLE MOUNTING TIE



UNIT : mm



Item No.	Length		W	Packing
	mm	inch		
PMA-150	144.6	5 11/16"	7	100pcs

- Material: UL approved Nylon 66, 94V-2
- Application: Fix with the bolt (as Figure) and insert the tie through the locking head.

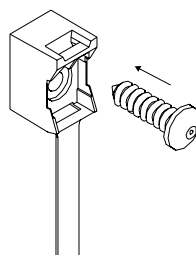
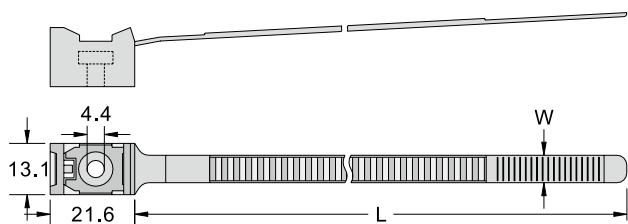

0319 KSS SADDLE MOUNTING TIE



UNIT : mm



Item No.	Length		W	Packing
	mm	inch		
PMB-145	144.6	5 11/16"	7.1	100pcs
PMB-240	238.2	9 3/8"	7.1	

- Material: UL approved Nylon 66, 94V-2
- Color: Natural
- Application: Drill a 8mm diameter round hole for CWP-38 wall plug (as Figure), insert CWP-38 onto the tie head and fix objects on the wall by locking the tie. The tie can also be fixed on the wall with the bolt.
- Standard color is natural, other special colors are available upon request.



CWP-38
(Refer to P.90)

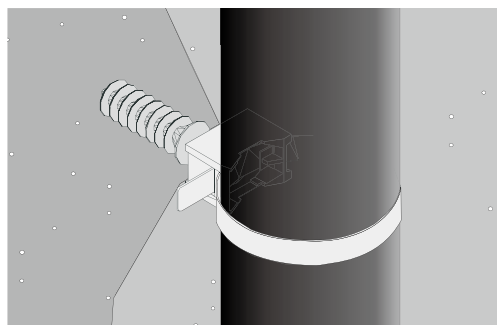
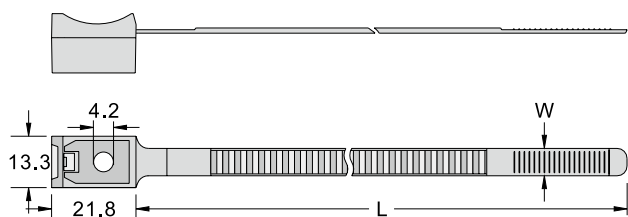

0320 KSS DOUBLE LOCKING CABLE TIE



- Material : UL approved Nylon 66 , 94V-2 or Nylon12 , 94HB.
- Color: Natural , Black
- Single locking head: DL-132, DL-180

◆ NYLON 66 Single locking

UNIT : mm

Item No.		Length		W	Max.Bundle Dia.	Min LoopTensile Strength		Packing
Natural	Black	mm	inch			lbs	kgs	
DL-132	DL-132BK	132	5 1/8"	9	25	79	36	100 pcs
DL-180	DL-180BK	180	7"	9	40	79	36	

◆ NYLON 66 Double locking

Item No.		Length		W	Max.Bundle Dia.	Min LoopTensile Strength		Packing
Natural	Black	mm	inch			lbs	kgs	
DL-235	DL-235BK	235	9 1/4"	9	53	120	55	100 pcs
DL-265	DL-265BK	265	10 1/2"	9	78	120	55	
DL-300	DL-300BK	300	11 7/8"	9	88	120	55	
DL-360	DL-360BK	360	14 1/4"	9	100	120	55	
DL-510	DL-510BK	510	20"	9	150	120	55	
DL-610	DL-610BK	610	24"	9	180	120	55	
DL-760	DL-760BK	760	30"	9	230	120	55	

◆ NYLON 12 Single locking

Item No.	Length		W	Max.Bundle Dia.	Min LoopTensile Strength		Packing
Black	mm	inch			lbs	kgs	
DL-132N12BK	132	5 1/8"	9	25	55	25	100 pcs
DL-180N12BK	180	7"	9	40	55	25	

◆ NYLON 12 Double locking

Item No.	Length		W	Max.Bundle Dia.	Min LoopTensile Strength		Packing
Black	mm	inch			lbs	kgs	
DL-235N12BK	235	9 1/4"	9	53	112	51	100 pcs
DL-265N12BK	265	10 1/2"	9	78	112	51	
DL-300N12BK	300	11 7/8"	9	88	112	51	
DL-360N12BK	360	14 1/4"	9	100	112	51	
DL-510N12BK	510	20"	9	150	112	51	
DL-610N12BK	610	24"	9	180	112	51	
DL-760N12BK	760	30"	9	230	112	51	

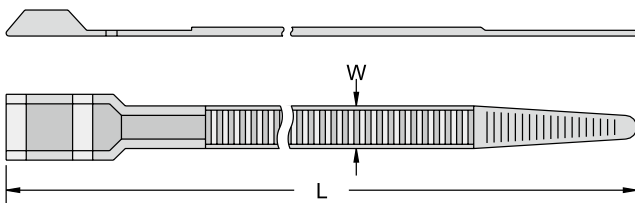

DL-132,DL-180

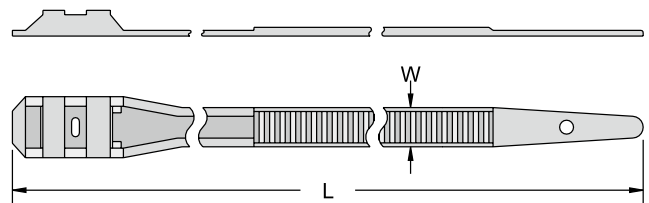

Standard design

0320 KSS DOUBLE LOCKING CABLE TIE



- Material : UL approved Nylon 6, 94HB
- Color: Black

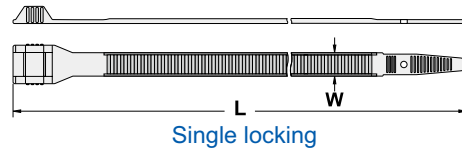

Single locking

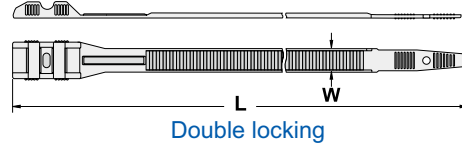

Double locking

◆ NYLON 6 Single locking

Item No.	Length		W	Max.Bundle Dia.	Min LoopTensile Strength		Packing
	mm	inch			lbs	kgs	
DL-180N6BK	180	7"	9.0	40	80	36	100 pcs

◆ NYLON 6 Double locking

Item No.	Length		W	Max.Bundle Dia.	Min LoopTensile Strength		Packing
	mm	inch			lbs	kgs	
DL-265N6BK	265	10 1/2"	9.0	63	120	55	100 pcs
DL-360N6BK	360	14 1/4"	9.0	92	120	55	

0320 KSS DOUBLE LOCKING CABLE TIE



- Material: UL approved Nylon 66, 94V-2
- Single locking head: DK-132S, DK-180, DK-180S, DK-200

◆ Single locking

UNIT : mm

Item No.		Length		W	Max.Bundle Dia.	Min LoopTensile Strength		Packing
		mm	inch			lbs	kgs	
DK-132SBK	Natural	132	5 1/8"	6	25	50	22	100 pcs
DK-180SBK		180	7"	6	40	50	22	
DK-180BK		180	7"	9	40	80	36	
DK-200BK	DK-200	201	8"	9	47	80	36	

◆ Double locking

Item No.		Length		W	Max.Bundle Dia.	Min LoopTensile Strength		Packing
		mm	inch			lbs	kgs	
DK-265BK		265	10 1/2"	9	64	120	55	100 pcs
DK-290BK	DK-290	292	11 1/2"	9	72	120	55	
DK-360BK		360	14 1/4"	9	95	120	55	
DK-380BK	DK-380	382	15"	9	100	120	55	
DK-510BK		510	20"	9	142	120	55	
DK-610BK	DK-610	610	24"	9	174	120	55	
DK-760BK		760	30"	9	214	120	55	

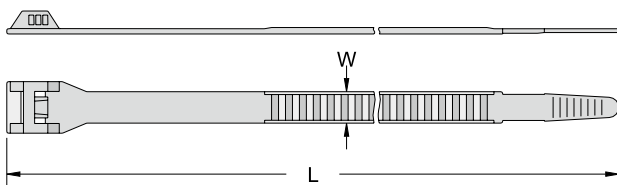

Single locking

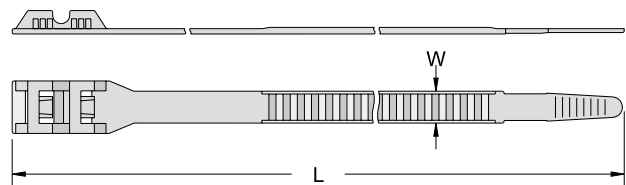

Double locking

0321 KSS IN-LINE CABLE TIE



UNIT : mm



Item No.	Length		W	Max.Bundle Dia.	Packing
	mm	inch			
FCV-255	255	10"	9.0	74	100pcs
FCV-391	391	15 1/2"	9.0	117	

- Material: UL approved Nylon 66, 94V-2.
- Color : Natural and Black, other colors are available upon request.
- Feature: Flat headed low profile design to be used with playground equipment to avoid harming playing children.

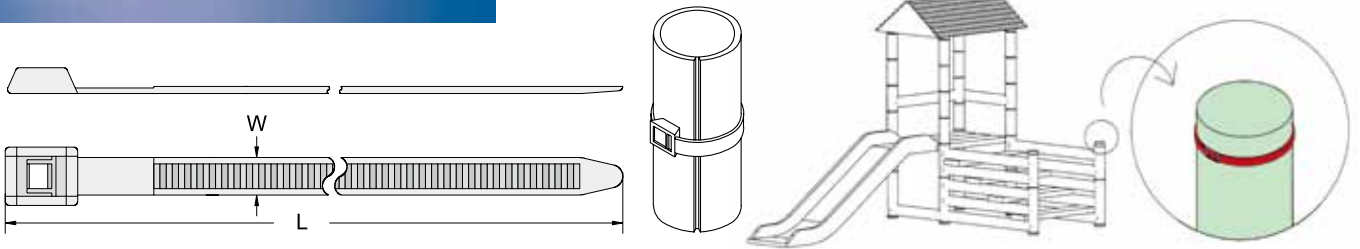

0321 KSS IN-LINE CABLE TIE



UNIT : mm



Item No.	Length		W	Max.Bundle Dia.	Packing
	mm	inch			
RRCV-100	103	4"	2.5	23	100pcs
RRCV-200D	203	8"	4.8	52	

- Material: UL approved Nylon 66, 94V-2.
- Feature : Reverse-insert design with pawl outside to eliminate the damage of object.

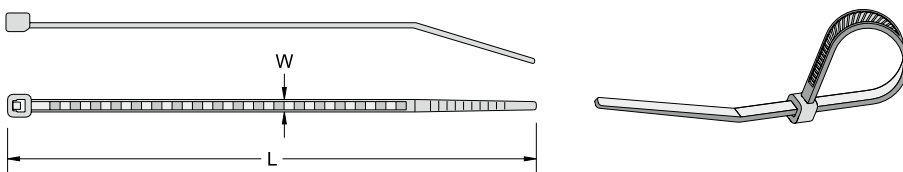

0325 KSS KNOT TIE (BEAD TYPE)



UNIT : mm



Item No.	Length		W	Max.Bundle Dia.	Packing
	mm	inch			
TV-100	103	4"	2.5	25	100 pcs
TV-120	120	4 3/4"	2.4	30	
TV-150	150	6"	2.9	39	
TV-180	180	7"	2.9	49	
TV-230	226	8 15/16"	3.8	63	
TV-280	273	11"	3.0	75	

- Material: UL approved Nylon 66, 94V-2
- Color: Natural
- Easy to install and release.
- Beaded design keeps wires from shifting or slipping.

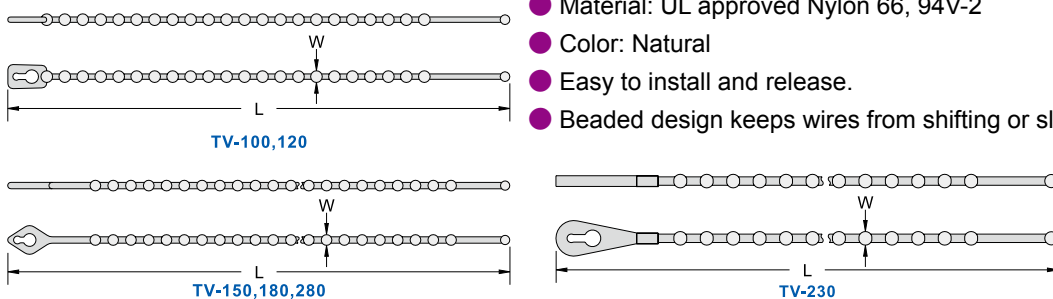

0326 KSS DOUBLE HEAD KNOT TIE



◆ NYLON 66

UNIT : mm

Item No.		Length		W	Max.Bundle Dia.	Packing
Natural	Black	mm	inch			
KTV-145	KTV-145BK	145	5 3/4"	2.0	35	100 pcs
KTV-150	KTV-150BK	150	6"	3.6	38	
KTV-170	KTV-170BK	167	6 9/16"	3.9	41	
KTV-180	KTV-180BK	180	7"	3.6	46	
KTV-230	KTV-230BK	230	8 15/16"	3.6	62	

- Material : Nylon 66
- Easy to install and release.
- Beaded design keeps wires from shifting or slipping.

◆ PE

Item No.		Length		W	Max.Bundle Dia.	Packing
Natural	Black	mm	inch			
KTV-145E	KTV-145EBK	145	5 3/4"	2.0	35	100 pcs
KTV-150E	KTV-150EBK	150	6"	3.6	38	
KTV-170E	KTV-170EBK	167	6 9/16"	3.9	41	
KTV-180E	KTV-180EBK	180	7"	3.6	46	
KTV-230E	KTV-230EBK	230	8 15/16"	3.6	62	

- Material : PE
- Easy to install and release.
- Beaded design keeps wires from shifting or slipping.

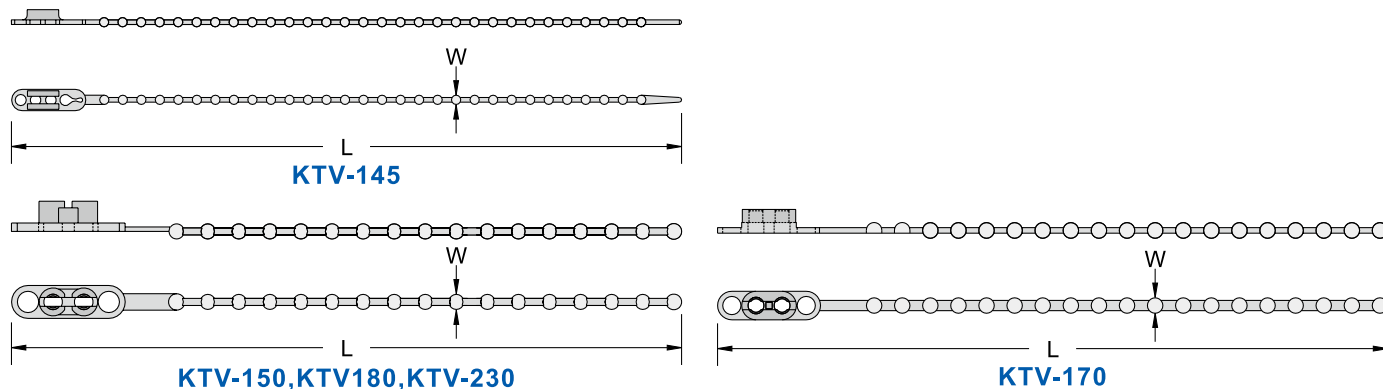

0327 KSS KNOT TIE



UNIT : mm



Item No.		Length		W	Max.Bundle Dia.	Packing
Red	Natural	mm	inch			
STV-130RD7	STV-130	130	5 1/8"	3	35	100 pcs

- Material: UL approved Nylon 66, 94V-2
- Mounting hole Diameter 6 mm ; chassis thickness 1.6 mm.
- Easy to install and release.
- Beaded design keeps wires from shifting or slipping.

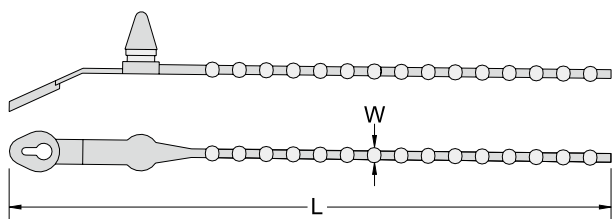

0330 KSS WIRE COLLECT TIE



UNIT : mm



Item No.		Length		W	Max.Bundle Dia.	Packing
Natural	Black	mm	inch			
TL-1	TL-1BK	130	5 1/8"	15.5	35	100 pcs
PCT-140	PCT-140BK	142	5 1/2"	9.0	38	
WL-160	WL-160BK	160	6 1/4"	8.5	45	
WLT-230	WLT-230BK	234	9 1/16"	5.5	50	
NEW	WLT-350BK	350	13 3/4"	7.0	100	

- Material: PE.
- Color: Natural. and Black.
- Application: Wrap electrical cords for shipping and packaging.
- Put the wire into A (see the diagram) firstly then roll up the wire and end it by collect tie.

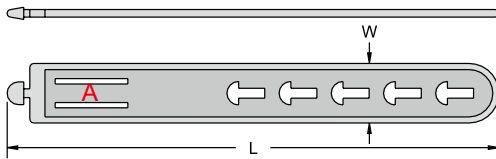
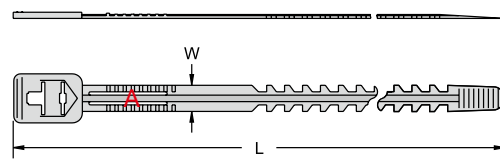
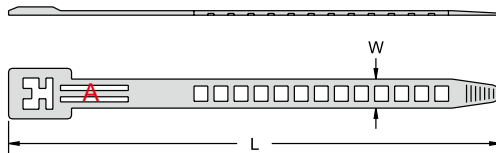
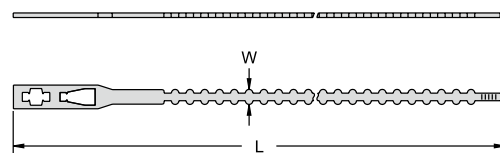
TL-1

WL-160

PCT-140

WLT-230
WLT-350

0332 KSS WIRE COLLECT TIE



UNIT : mm



Item No.		Length		W	Max.Bundle Dia.	Min LoopTensile Strength		Packing
Natural	Black	mm	inch			lbs	kgs	
WCT-165	WCT-165BK	165	6 1/2"	7	44	50	22	100 pcs

- Material: UL approved Nylon 66, 94V-2

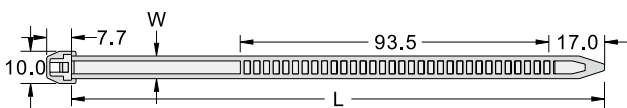

0335 KSS PUSH MOUNT TIE



UNIT : mm

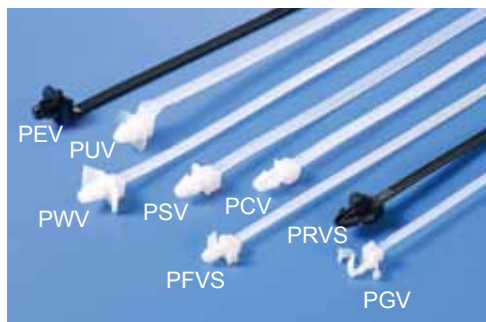

Using Method

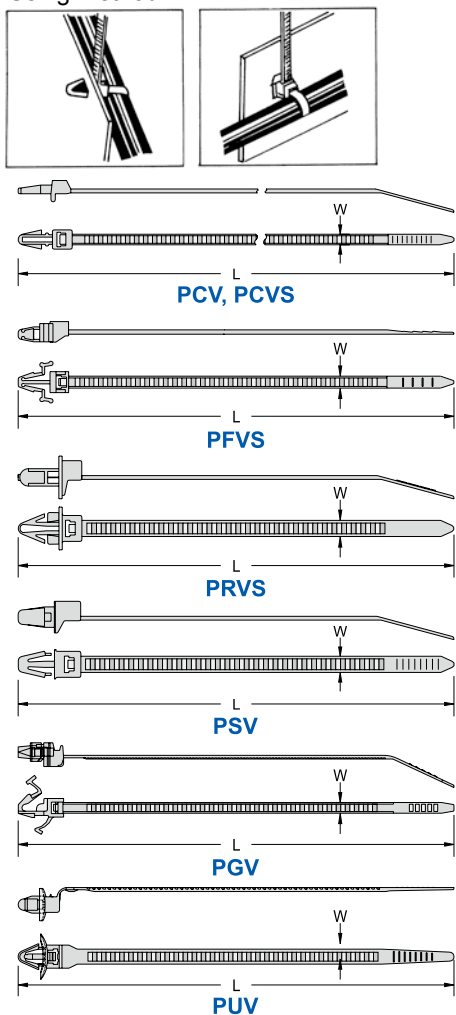

Item No.	Length		W	Max.Bundle Dia.	Mounting hole diameter	Chassis thickness	Min Loop Tensile Strength		Packing
	mm	inch					lbs	kgs	
PCVS-130	132	5 1/8"	4.8	30	4.8	3.0	50	22	100 pcs
PCV-155	168	6 1/8"	3.8	40	4.8	3.0	40	18	
PCVS-200	203	8"	4.8	50	4.8	3.0	50	22	
PCV-200	203	8"	4.8	50	6.4	3.0	50	22	
NEW PEV-170BK	170	6 11/16"	5.3	40	6.8	12.0	26	12	
UL LISTED PFVS-130	131	5 1/8"	3.7	30	4.8	2.4	40	18	
UL LISTED PFVS-155	157.5	6 1/8"	3.7	38	4.8	2.4	40	18	
UL LISTED PFVS-200	207	8"	3.7	50	4.8	2.4	40	18	
PGV-100	101	4 1/8"	3.4	25	4.8	2.5	40	18	
PGV-130	135	5 5/16"	3.4	33	4.8	2.5	40	18	
UL LISTED PSV-130	132	5 1/8"	4.8	30	6.4	3.3	50	22	
UL LISTED PSV-200	202	8"	4.8	50	6.4	3.3	50	22	
PUV-170	168.6	6 5/8"	5.4	38	6.8	1.6	50	22	
UL LISTED PWVS-100	112	4 3/8"	2.5	25	4.6	2.6	18	8	
UL LISTED PWVS-130	133	5 1/8"	4.8	30	4.6	4.5	50	22	
UL LISTED PWVS-155	157	6 1/8"	3.5	36	4.6	2.6	40	18	
UL LISTED PWV-130	132	5 1/8"	4.8	30	6.2	2.8	50	22	
UL LISTED PWV-170	170	6 11/16"	4.6	40	6.0	3.0	50	22	
UL LISTED PWV-200	201	8"	4.8	50	6.2	2.8	50	22	
PRVS-130HSBK	134.5	5 1/4"	4.8	30	8.2	5.0	50	22	

- Material: UL approved Nylon 66, 94V-2
- Press the tie into a pre-drilled hole and bind the cord by securing the tie.
- ※ PRVS-130HSBK : UL approved heat stabilized Nylon 66, 94V-2 black

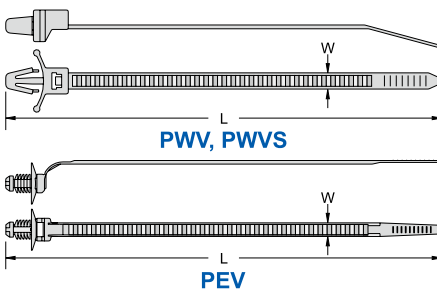

0335 KSS RELEASABLE PUSH MOUNT TIE



UNIT : mm



Item No.	Length		W	Max.Bundle Dia.	Mounting hole diameter	Chassis thickness	Min Loop Tensile Strength		Packing
	mm	inch					lbs	kgs	
PDV-170BK	169	6 5/8"	5.0	36	7.0	15	40	18	100 pcs

- Material: UL approved Nylon 66, 94V-2
- Application: Drill the panel board, insert the tie into the hole and fasten the cable.
- Feature: Releasable.

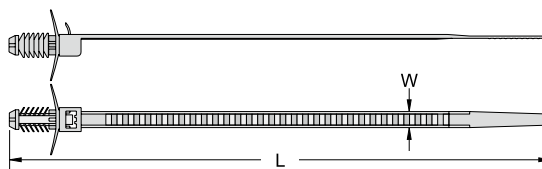

0340 KSS CABLE TRAY FIXING TIE



UNIT : mm



Item No.		Length		L1	L2	W	Min Loop Tensile Strength		Packing
Black	Natural	mm	inch				lbs	kgs	
CTF-320BK	CTF-320	320	12 5/8"	40	278	7.6	120	55	100pcs

● Material: UL approved Nylon 66, 94V-2

● Application:

1. Snap the cable tray fixing tie from (A) to separate the head and the tail.
2. Slot each (B) into either side of the tray and fix both parts by twisting 90 degree.
3. Secure the cables and wires on dedicated area.

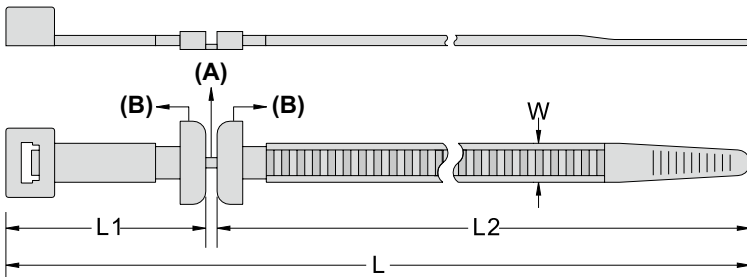

0342 KSS CHASSIS TIE



UNIT : mm



Item No.	Length		W	Max. Bundle Dia.	Packing
	mm	inch			
KFC-300BK	304	11 7/8"	6.2	85	100pcs
KFC-380BK	380	15"	7.6	100	
KFS-380BK	380	15"	7.6	100	

● Material: UL approved Nylon 66, 94V-2

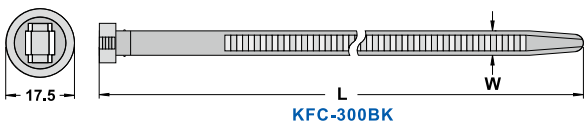

KFC-300BK

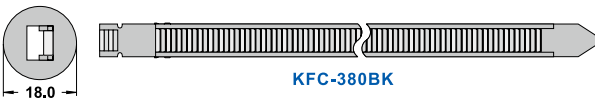

KFC-380BK

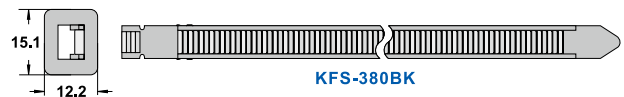

KFS-380BK

0343 KSS MOUNTING ADJUSTABLE TIE



UNIT : mm

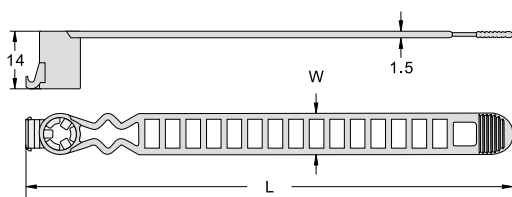

Item No.	Length		W	Screw	Packing
	mm	inch			
MAT-120BK	120	4 3/4"	10	5.0	100pcs

- Material: UL approved Nylon 66, 94V-2
- Application: Press the tie head against the bolt, which is fixed to the board panel, and fasten the cable by locking the tie.
- Feature:
 1. Ladder Design Strap, which is adjustable.
 2. Loose by rotating it counterclockwise.

0350 KSS MAGIC CABLE TIE



UNIT : mm



Item No.	Length		W	Max.Bundle Dia.	Color	Packing
	mm	inch				
MGT-125	125	5"	12	30	BK WE RD YW BE GN	20pcs
MGT-135	135	5 5/16"	12	33		
MGT-150	150	6"	12	36		
MGT-150M	150	6"	10	36		
MGT-180	180	7"	12	40		
MGT-210	210	8 1/4"	16	50		
MGT-240	240	9 7/16"	16	65		
MGT-310	310	12"	16	85		

Item No.	W	Color	Packing
MGTP-15	15	BK , WE , RD	10M/Roll
MGTP-20	20	YW , BE , GN	3M/Roll is available upon request

- Material: Hook Side: PP, Loop Side: Nylon
- Color: Black (BK), White (WE), Red (RD), Yellow (YW), Blue (BE), Green (GN)
- Application: Cord and cable management (UTP/STP/FIBER), wire harnesses, prevent interruption to transmission speed when using traditional Nylon cable ties. Reusable and easy to install.

0355 KSS NYLON CABLE TIE WITH STOPPER



UNIT : mm



Item No.	Length		W	Max.Bundle Dia.	Min LoopTensile Strength		Packing
	mm	inch			lbs	kgs	
CVS-140	142	5 1/2"	3.2	20	40	18	100pcs
CVS-190	190	7 1/2"	4.8	45	50	22	
CVS-380XL	380	15"	12.7	105	250	114	

- Material: UL approved Nylon 66, 94V-2
- Feature: A stopper built on tie to ensure the minimum bundle loop.

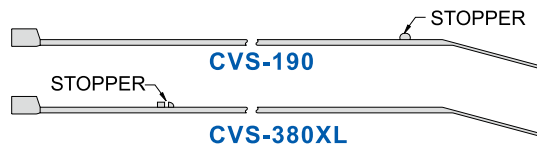
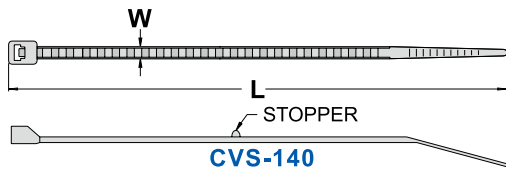

0361 KSS COATED COPPER TUBE CABLE TIE



UNIT : mm



Item No.	Length		W	Max.Bundle Dia.	Packing
	mm	inch			
AT-250	235	9 1/4"	20	65	100pcs
AT-290	275	10 13/16"	20	75	

- Material: PE.
- Color: Natural
- Function: Used for coated copper tube in air conditioning system.
- Feature: L shape design suitable for tying wires.

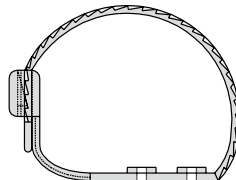
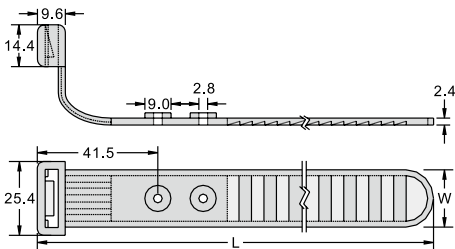

0365 KSS CABLE TIE WITH DECORATION TAG



UNIT : mm



NEW

Item No.	Cable Tie Length	Content/Color		Packing
PVF150C-20	150	Clover/Neon Green	Apple/Neon Green	20 pcs / Box 2 pcs / type
		Heart/Pink	Ribbon/Pink	
		Butterfly/Yellow	Star/Yellow	
		Flower/Neon Orange	Giraffe/Neon Orange	
		Rabbit/Blue	Elephant/Blue	

- Material: UL approved Nylon 66, 94V-2
- Function: Use for decoration when bundling wires, DIY as stationery, gift, packaging material, labeling, etc. It can show your personal style.
- Features: TAIWAN EXCELLENCE 2015 awarded product.
 1. Exchangeable decoration tags.
 2. Exchanging decoration tag by a simple rotation.
 3. Releasable, reusable and environment friendly.
- ※ Special color, length, design, package available on request.

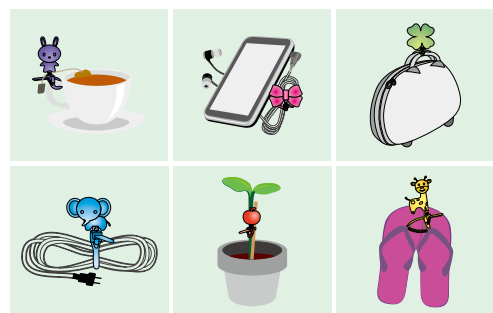

PATENT

0365 KSS CABLE TIE WITH 360 DEGREE ROTATION TAG



UNIT : mm



NEW

Item No.	Cable Tie Length	Content/Color		Packing
PVA150C-20	150	Butterfly/Pink	Giraffe/Neon Orange	20 pcs / Box 5 pcs / type
		Rabbit/Neon Green	Elephant/Blue	

- Material: UL approved Nylon 66, 94V-2
- Function: Use for decoration when bundling wires, DIY as stationery, gift, packaging material, labeling, etc. It can show your personal style.
- Features:
 1. Exchangeable decoration tags.
 2. 360 degree rotatable tag can exchange by pulling & plugging.
 3. Releasable, reusable and environment friendly.
- ※ Special color, length, design, package available on request.

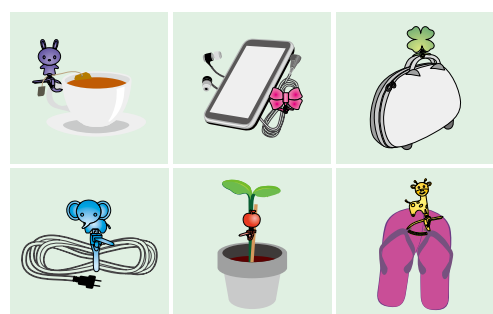
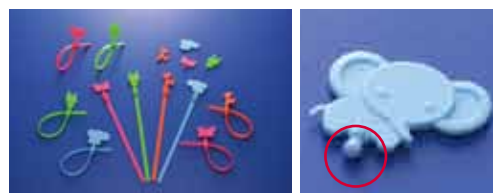

PATENT

0365 KSS HOOK TIE



UNIT : mm

NEW

PATENT

Item No.	Cable Tie Length	Content	Color	Packing
DP-2-A05NYW	150	Star	Yellow	2 pcs / Bag
DP-2-A06PK		Flower	Pink	
DP-2-A11NOE		Ribbon	Orange	
DP-2-A02NGN3		Clover	Green	

- Material: UL approved Nylon 66, 94V-2, with good tensile strength and insulation, not easy to age.
 - Function: Using it in your kitchen, bathroom or bedroom, even on your baby stroller, convenient for bundling and hanging stuff.
 - Features: TAIWAN EXCELLENCE 2017 awarded product.
 1. Two-directions hook tie.
 2. 360 degree rotatable hook fits any direction.
 3. Releasable, reusable and environment friendly.
 4. The load is up to 1.5Kgf proved by SGS laboratory.
- ※ Special color, length, design, package available on request.



0365 KSS LUGGAGE TIE



UNIT : mm

NEW

PATENT
NEW

Item No.	Color	L1		L2		W	Content	Packing
		mm	inch	mm	inch			
DP-2-DE1NBK	Black	150	6"	200	8"	4.8	Taiwan	2 pcs / Bag
DP-2-DE1NGN3	Green							

- Material: UL approved Nylon 66, 94V-2, with good tensile strength and insulation, not easy to age.
 - Function: Using it on luggage or backpacks helping you carry more extra bags when traveling, or other application you can image.
 - Features: TAIWAN EXCELLENCE 2017 awarded product.
 1. Cultural theme: cable tie with Taiwan design.
 2. Double lock. Multi-function.
 3. Releasable, reusable and environment friendly.
 4. Hanging bags on luggage or backpacks easily.
 5. The load is up to 20Kgf proved by SGS laboratory.
- ※ Special color, length, design, package available on request.

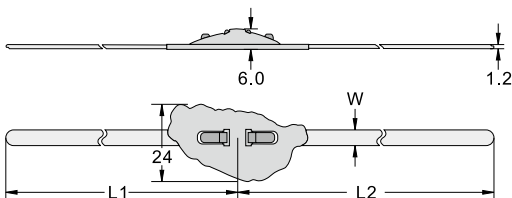

0370 KSS STAINLESS STEEL CABLE TIE



UNIT : mm

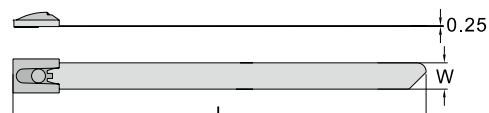

(Refer to P.58)

◆ 316SS

Item No.	Length		W	lbs	Max.Bundle Dia.	Packing
	mm	inch				
BST-127	127	5"	4.6	100	25	100 pcs
BST-152	152	6"	4.6	100	33	
BST-201	201	8"	4.6	100	51	
BST-266	266	10 1/2"	4.6	100	69	
BST-300	300	11 7/8"	4.6	100	80	
BST-362	362	14 1/4"	4.6	100	102	
BST-521	521	20 1/2"	4.6	100	152	
BST-679	679	26 3/4"	4.6	100	203	50 pcs
BST-838	838	33"	4.6	100	254	
BST-127L	127	5"	7.9	250	25	100 pcs
BST-152L	152	6"	7.9	250	33	
BST-201L	201	8"	7.9	250	51	
BST-266L	266	10 1/2"	7.9	250	69	
BST-300L	300	11 7/8"	7.9	250	80	
BST-362L	362	14 1/4"	7.9	250	102	
BST-521L	521	20 1/2"	7.9	250	152	
BST-679L	679	26 3/4"	7.9	250	203	50 pcs
BST-838L	838	33"	7.9	250	254	

◆ 304SS

Item No.	Length		W	lbs	Max.Bundle Dia.	Packing
	mm	inch				
BCT-127	127	5"	4.6	100	25	100 pcs
BCT-152	152	6"	4.6	100	33	
BCT-201	201	8"	4.6	100	51	
BCT-266	266	10 1/2"	4.6	100	69	
BCT-300	300	11 7/8"	4.6	100	80	
BCT-362	362	14 1/4"	4.6	100	102	
BCT-521	521	20 1/2"	4.6	100	152	
BCT-679	679	26 3/4"	4.6	100	203	50 pcs
BCT-838	838	33"	4.6	100	254	
BCT-127L	127	5"	7.9	250	25	100 pcs
BCT-152L	152	6"	7.9	250	33	
BCT-201L	201	8"	7.9	250	51	
BCT-266L	266	10 1/2"	7.9	250	69	
BCT-300L	300	11 7/8"	7.9	250	80	
BCT-362L	362	14 1/4"	7.9	250	102	
BCT-521L	521	20 1/2"	7.9	250	152	
BCT-679L	679	26 3/4"	7.9	250	203	50 pcs
BCT-838L	838	33"	7.9	250	254	

- Material : Stainless Steel 316SS or 304SS
- Suit for engineering, aviation, ship area.
- Feature: Fast locking function, can be quick & easy installed. Designed for indoor and outdoor, Apply for severe environment like high-humidity, high-temperature, chemically, and coldness conditions.
- ※ Other sizes available upon request.

0371 KSS STAINLESS STEEL TIE WITH COATING



UNIT : mm

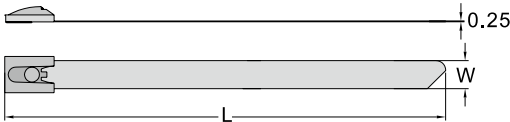

(Refer to P.58)

Item No.	Length		W	lbs	Max.Bundle Dia. mm	Packing
	mm	inch				
BSTC-127	127	5"	4.6	100	25	100 pcs
BSTC-152	152	6"	4.6	100	33	
BSTC-201	201	8"	4.6	100	51	
BSTC-266	266	10 1/2"	4.6	100	69	
BSTC-300	300	11 7/8"	4.6	100	80	
BSTC-362	362	14 1/4"	4.6	100	102	
BSTC-521	521	20 1/2"	4.6	100	152	
BSTC-679	679	26 3/4"	4.6	100	203	50 pcs
BSTC-838	838	33"	4.6	100	254	
BSTC-127L	127	5"	7.9	150	25	100 pcs
BSTC-152L	152	6"	7.9	150	33	
BSTC-201L	201	8"	7.9	150	51	
BSTC-266L	266	10 1/2"	7.9	150	69	
BSTC-300L	300	11 7/8"	7.9	150	80	
BSTC-362L	362	14 1/4"	7.9	150	102	
BSTC-521L	521	20 1/2"	7.9	150	152	
BSTC-679L	679	26 3/4"	7.9	150	203	50 pcs
BSTC-838L	838	33"	7.9	150	254	

- Material: Stainless Steel 316SS with Epoxy coating.
- Suit for engineering, aviation, ship area.
- Feature: Fast locking function, can be quick & easy installed. Special Epoxy coating to make stainless steel cable tie more insulation, anti-corrosion.
- ※ Other sizes available upon request.

0372 KSS LADDER TYPE STAINLESS STEEL TIE WITH COATING



UNIT : mm

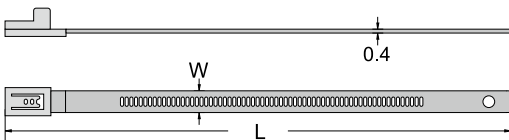

Item No.	Length		W	Max.Bundle Dia. mm	Packing
	mm	inch			
ASTN-150	150	6"	7	35	100 pcs
ASTN-195	195	7 11/16"	7	49	
ASTN-225	225	9"	7	58	
ASTN-255	255	10"	7	68	
ASTN-300	300	11 7/8"	7	82	
ASTN-335	335	13 3/16"	7	93	
ASTN-375	375	14 3/4"	7	106	
ASTN-450	450	17 3/4"	7	130	50 pcs
ASTN-610	610	24"	7	181	
ASTN-150L	150	6"	12	35	
ASTN-195L	195	7 11/16"	12	49	
ASTN-225L	225	9"	12	58	
ASTN-255L	255	10"	12	68	
ASTN-300L	300	11 7/8"	12	82	
ASTN-335L	335	13 3/16"	12	93	
ASTN-375L	375	14 3/4"	12	106	
ASTN-450L	450	17 3/4"	12	130	
ASTN-610L	610	24"	12	181	

- Material: Stainless Steel 316SS with Nylon11 coating.
- Suit for engineering, aviation, ship area.
- Feature: Quick to fasten and adjustable length. Fast and easy application. Special Nylon11 coating to make stainless steel cable tie more abrasion resistance, weather resistance, impact resistance.
- ※ Other sizes available upon request.

0373 KSS STAINLESS STEEL TIE WITH COATING



UNIT : mm

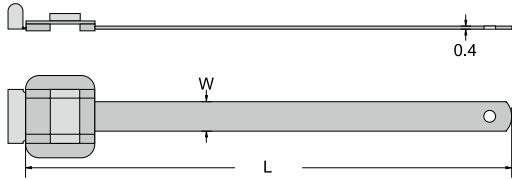

Item No.	Length		W	Max.Bundle Dia. mm	Packing
	mm	inch			
RSTN-152	152	6"	6.3	35	50 pcs
RSTN-229	229	9"	6.3	60	
RSTN-305	305	12"	6.3	84	
RSTN-457	457	18"	6.3	132	
RSTN-610	610	24"	6.3	181	
RSTN-152L	152	6"	9.5	35	
RSTN-229L	229	9"	9.5	60	
RSTN-305L	305	12"	9.5	84	
RSTN-457L	457	18"	9.5	132	
RSTN-610L	610	24"	9.5	181	

- Material: Stainless Steel 316SS with Nylon11 coating.
- Suit for engineering, aviation, ship area.
- Feature: Quick Fastening and re-used. Fast and easy application. Special Nylon11 coating to make stainless steel cable tie more abrasion resistance, weather resistance, impact resistance.
- ※ Other sizes available upon request.



WRAPPING BAND

0401 KSS SPIRAL WRAPPING BAND



UNIT : mm



Box

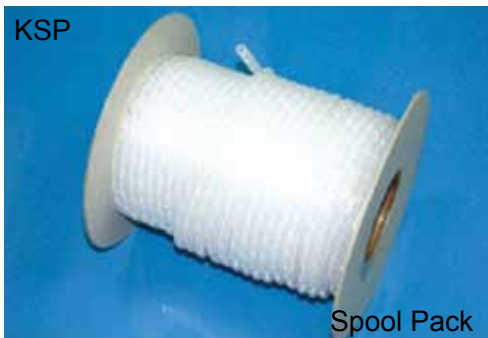

KSP

Spool Pack

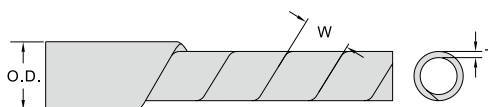

O.D. AS PRODUCTION
(BEFORE CUT IN LENGTH)
Standard design

◆ PE

Item No.	O.D.	T	W	Wrapping Range	Packing	Material
KS-3	3.0	0.5	4.7	1.5~10	10M / Bag	PE
KS-6	4.5	0.6	6.7	2.5~15		
KS-6L	6.0	0.6	7.4	4~25		
KS-6.5	6.5	0.55	7.9	5~25		
KS-8	8.0	0.75	12.0	6~30		
KS-10	10.0	0.8	12.3	7.5~30		
KS-12	12.0	0.85	15.0	9~32		
KS-15	15.0	1.0	15.5	12~35		
KS-19	19.0	1.2	19.2	15~50		
KS-24	24.0	1.3	21.5	20~100		
NEW KS-32	32.0	1.5	25.0	28~120		

◆ PE Box

Item No.	O.D.	T	W	Wrapping Range	Packing (Box)	Material
NEW KS-8-400M	8.0	0.75	12.0	6~30	400M	PE
NEW KS-10-250M	10.0	0.8	12.3	7.5~30	250M	
NEW KS-12-170M	12.0	0.85	15.0	9~32	170M	
NEW KS-15-120M	15.0	1.0	15.5	12~35	120M	
NEW KS-19-80M	19.0	1.2	19.2	15~50	80M	
NEW KS-24-50M	24.0	1.3	21.5	20~100	50M	

◆ PE SPOOL PACK

Item No.	O.D.	T	W	Wrapping Range	Packing	Material
KSP-3	3.0	0.5	4.7	1.5~10	100 FT (30.5M) / Roll	PE
KSP-6	4.5	0.6	6.7	2.5~15		
KSP-6L	6.0	0.6	7.4	4~25		
KSP-6.5	6.5	0.55	7.9	5~25		
KSP-8	8.0	0.75	12.0	6~30		
KSP-10	10.0	0.8	12.3	7.5~30		
KSP-12	12.0	0.85	15.0	9~32		
KSP-15	15.0	1.0	15.5	12~35		
KSP-19	19.0	1.2	19.2	15~50		
KSP-24	24.0	1.3	21.5	20~100		

◆ NYLON 6

Item No.	O.D.	T	W	Wrapping Range	Packing	Material
KS-6N6	4.5	0.45	8.0	4~25	10M / Bag	NYLON 6
NEW KS-6LN6	6.0	0.52	8.0	4~25		
KS-6.5N6	6.5	0.55	7.4	5~25		
KS-8N6	8.0	0.7	12.0	6~30		
KS-10N6	10.0	0.7	12.5	7.5~30		
KS-12N6	12.0	0.7	16.0	9~32		
KS-15N6	15.0	0.8	16.8	12~35		
KS-19N6	19.0	0.9	19.4	15~50		
KS-24N6	24.0	0.9	20.5	20~100		

- Color: Standard in natural. Black and other colors are available upon request.
- Description:
 1. Flexible construction enable bands to follow wire ways easily.
 2. Durable, reusable with retained spiral strength.
 3. Fix ends of band with KSS cable ties and spiral wire bundles in clockwise direction to complete works.
 4. Expand spiral range almost without limit. An economical way of cable binding. Easily applied to electric harness, cables and wire bundles. Cut-to-fit versatility in convenient roll-form.
- A reverse design is available.

0401 KSS SPIRAL WRAPPING BAND



UNIT : mm



◆ HDPE

Item No.	O.D.	T	W	Wrapping Range	Packing	Material
KS-30HYW	33.0	2.5	41.0	26~50	2M / pc	HDPE
KS-60HYW	60.0	2.5	27.0	60~80		

- Material : HDPE
- Color: Yellow, other colors are available upon request.
- Description:
 1. Flexible construction enable bands to follow wire ways easily.
 2. Durable, reusable with retained spiral strength.
 3. Fix ends of band with KSS cable ties and spiral wire bundles in clockwise direction to complete works.
 4. Expand spiral range almost without limit. An economical way of cable binding. Easily applied to electric harness, cables and wire bundles. Cut-to-fit versatility in convenient roll-form.
- A reverse design is available.

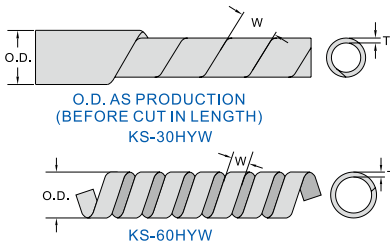

0402 KSS SPLIT WRAPPING BAND



UNIT : mm



Item No.	D	T	W	Wrapping Range	Packing	Material
KL-8BK	8	0.8	9	10	5M / Roll / Bag	PP
KL-15BK	15	0.8	13	16		
KL-20BK	20	0.9	15	22		
KL-25BK	25	1.3	18	27		
KL-32BK	32	1.3	23	35		
NEW KL-6PE	6.2	0.8	9	6.5	5M / Roll / Bag	PE

- Material : PP , PE
- Color : Black, other color available upon request
- Application :
 1. Cut into suitable length, and use the special tool to wrap band the wire easily.
 2. Hold the topside of wire with installation tool, and draw down to wrap the wire immediately by easy and fast.
 3. This wire band designed to be easy off and re-usable, the tensile power will be remain after every wrap and peel.
- Tensile power : Easily applied and safety to protect cables and wire bundles from damage and electric harmless.

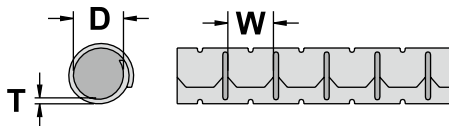

0402 KSS SPLIT WRAPPING BAND INSTALLATION TOOL



UNIT : PC



Item No.	D	To Be Used With	Packing
NEW KT-6BK	5	KL-6PE	10 pcs / Bag
KT-8BK	8	KL-8BK	
KT-15BK	15	KL-15BK	
KT-20BK	20	KL-20BK	
KT-25BK	25	KL-25BK	
KT-32BK	32	KL-32BK	

- Material : PP
- Color : Black

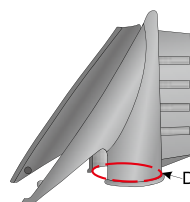
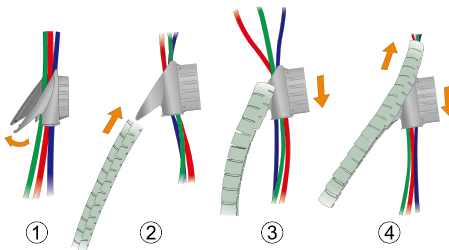

0403 KSS WRAPPING BAND



UNIT : mm

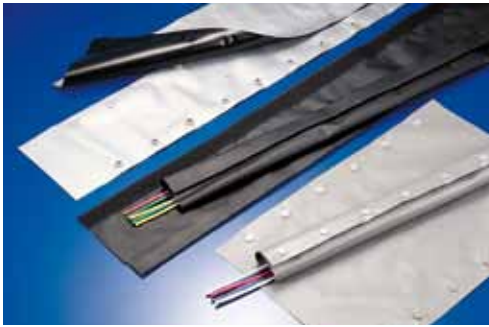

cut-to-fit versatility in convenient roll-form

◆ Button Type

Item No.		Button Distance	Max. Bundle Dia.	Packing (Spool)
Grey	Black / Grey			
WB-40	WBS-40	40	12	55M / RL
WB-47	WBS-47	47	15	
WB-60	WBS-60	60	20	
WB-80	WBS-80	80	25	
WB-100	WBS-100	100	30	
WB-128	WBS-128	128	40	
WB-140	WBS-140	140	44	
WB-150	WBS-150	150	47	
WB-160	WBS-160	160	50	
WB-182	WBS-182	182	57	
WB-222	WBS-222	222	70	
WB-315	WBS-315	315	100	
WB-475	WBS-475	475	150	
NEW WB-40-10M	WBS-40-10M	40	12	
NEW WB-47-10M	WBS-47-10M	47	15	
NEW WB-60-10M	WBS-60-10M	60	20	
NEW WB-80-10M	WBS-80-10M	80	25	
NEW WB-100-10M	WBS-100-10M	100	30	
NEW WB-128-10M	WBS-128-10M	128	40	
NEW WB-140-10M	WBS-140-10M	140	44	
NEW WB-150-10M	WBS-150-10M	150	47	
NEW WB-160-10M	WBS-160-10M	160	50	
NEW WB-182-10M	WBS-182-10M	182	57	
NEW WB-222-10M	WBS-222-10M	222	70	
NEW WB-315-10M	WBS-315-10M	315	100	
NEW WB-475-10M	WBS-475-10M	475	150	

◆ Tape Type

Item No.	Band width	Max. Bundle Dia.	Packing (Spool)
WBT-48	48	9	55M / RL
WBT-63	63	15	
WBT-84	84	20	
WBT-100	100	25	
WBT-115	115	30	
WBT-147	147	40	
WBT-183	183	50	
WBT-246	246	70	
WBT-340	340	100	
NEW WBT-48-10M	48	9	10M / Bag
NEW WBT-63-10M	63	15	
NEW WBT-84-10M	84	20	
NEW WBT-100-10M	100	25	
NEW WBT-115-10M	115	30	
NEW WBT-147-10M	147	40	
NEW WBT-183-10M	183	50	
NEW WBT-246-10M	246	70	
NEW WBT-340-10M	340	100	

● Material : PVC Flamability rating UL approved UL94VTM-0

● Application:

1. Good for cable wrapping
2. Easy to wrap, re-usable

0405 KSS BINDING BAND



UNIT : mm



Item No.	W	Material	Packing
A-6	6	PVC	10M / Bag
A-8	8		
A-10	10		
A-12	12		
A-6B	Buttons For Band	PE	100pcs / Bag
A-8B			
A-10B			
A-12B			

- Constructed of natural PVC which is outstanding in resisting effects of water, grease, chemicals.
- Used for fastening or supporting cable, pipe, wire bundles, wire harness.
- Low cost for permanent application. Button up band is all.

0410 KSS BINDING BAND



UNIT : mm

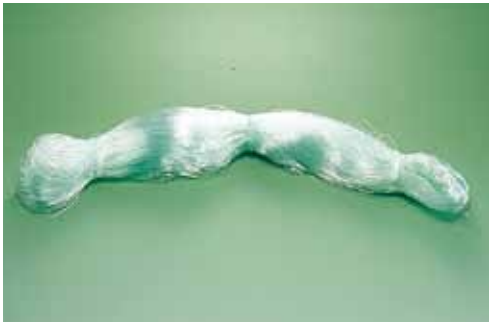

Item No.	Size	Packing
B-1	1.0 mm	1 Bundle

- Material: PVC
- Color: Natural white
- Diameter: 1m/m (solid)
- Packing: per bundle

0420 KSS PVC VINYL TIE

UNIT : mm



Item No.	Color	Packing
M-1	Black	1 Kgs / Roll

- Material: PVC
- Color : Black (Red 、 White 、 Blue 、 Yellow or Green available upon request)

0421 KSS PET TIE



UNIT : mm



Item No.	Color	Packing
PET-1	Black \ White	450 M / Roll

- Color : Black \ White
- ※No Metal inside

0425 KSS SNAP BAND



UNIT : mm



Item No.	Size	Packing
SNB-03	As Figure	100pcs

- Material: UL approved Nylon 66, 94V-2
- Color : Black, available in natural or other colors.

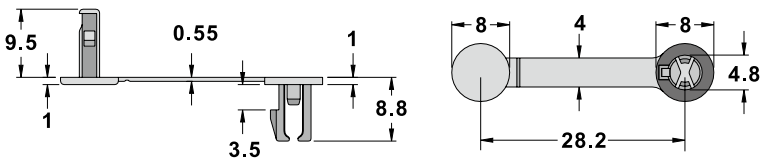



CABLE CLAMPS

0501 KSS CABLE CLAMP



UNIT : mm

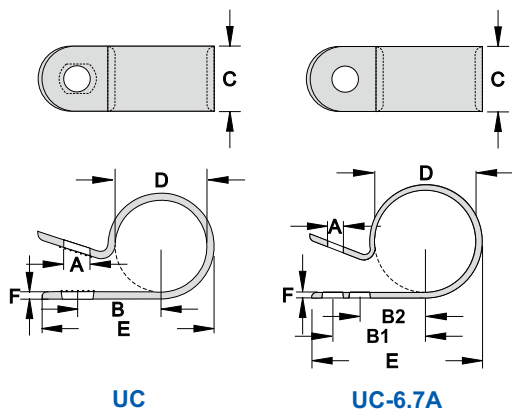

Item No.	A	B	C	D	Bundle Dia.	E	F	Packing
UC-0	4.8	8.0	9.6	3.3	3.1 (1/8")	16.9	1.05	100pcs
UC-0.5	4.8	9.2	9.6	5.3	5.0 (3/16")	18.5	1.05	
UC-1	4.6	10.4	10.1	6.8	6.35 (1/4")	20.0	1.1	
UC-1.5S	4.8	11.2	10.0	7.6	7.2 (9/32")	22.6	1.15	
UC-1.5	5.0	11.2	10.0	8.4	7.9 (5/16")	22.6	1.15	
UC-2	5.0	12.5	12.3	10.8	9.5 (3/8")	26.6	1.4	
UC-3	5.0	14.8	12.2	13.8	12.7 (1/2")	30.3	1.4	
UC-4	5.0	15.8	12.4	17.4	15.8 (5/8")	32.6	1.4	
UC-5	4.8	18.0	11.8	19.9	19.4 (3/4")	37.3	1.4	
NEW UC-5.5	5.5	21.9	13.0	22.8	22.2 (7/8")	40.4	1.4	
UC-6	5.0	21.0	12.0	27.2	25.4 (1")	43.4	1.4	
UC-6.5	4.8	26.0	12.6	30.6	27.5 (1 1/16")	51.5	1.7	
UC-7	4.7	26.0	12.0	33.8	31.8 (1 1/4")	52.3	1.6	
UC-9	4.8	27.8	12.5	41.9	36.7 (1 1/2")	58.3	1.5	

Item No.	A	B1	B2	C	D	Bundle Dia.	E	F	Packing
NEW UC-6.7A	5.4	25.6	17.2	13.0	28.5	22.8~28.5 (7/8")~(1 1/18")	47.0	1.5	100pcs

- Material: UL approved Nylon 66, 94V-2
- Color : Natural, available in other colors.
- KSS CABLE CLAMPS are designed to hold cables, tubes, and components in domestic appliance, electronics and electric apparatus generally.
- Interior edges are radiused to protect cable insulation.
- To apply, just clamp down on loosen cables and screw it to chassis.

0502 KSS ADJUSTABLE CABLE CLAMP



UNIT : mm

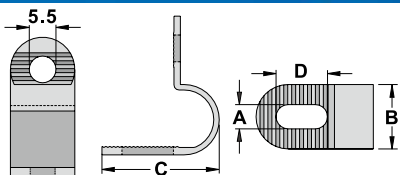

Item No.	A	B	C	D	Max.Bundle Dia.	Packing
PC-0406	5	13	23.5	10.4	4.8~6.4	100pcs
PC-0609	5	13	30.5	16.1	6.7~9.5	
PC-0914	5	13	40.0	20.7	9.5~14.3	

- Material: UL approved Nylon 66, 94V-2
- Color : Natural, available in other colors.
- Feature : Oval hole design for adjustable of bundling size.

0503 KSS CABLE CLAMP



UNIT : mm

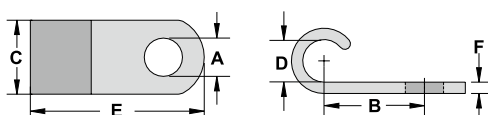

Item No.	A	B	C	D	E	F	Packing
KUC-5	4.4	11.6	8.5	5	20	1.3	100pcs

- Material: UL approved Nylon 66, 94V-2
- Color : Natural, available in other colors.

0505 KSS SELF ADHESIVE TIE MOUNT



UNIT : mm



Item No.	L	W	H	Mounting Hole	T	Packing
※ HC-100-S4	12.5	12.5	3.2		3.2	100pcs
※ HC-101S-S2	19.5	19.5	3.9	3.2	4.6	
HC-101S	19.5	19.5	3.9	3.2	4.6	
HC-101	21.8	21.8	4.0		4.8	
NEW HC-101SA	19.0	19.0	4.5	3.4	4.0	
HC-102	28.6	28.6	5.3	5.0	5.5	
NEW HC-102A	28.0	28.0	5.6	5.6	5.3	
HC-103	29.2	29.2	5.4	5.0	5.5	
HC-25	26.1	26.1	6.0	4.3	8.0	
HC-19R	18.9	18.9	4.6	4.8	4.2	
HC-26R	26.3	26.3	6.0	5.0	5.6	
HC-18T	19.0	19.0	5.0	4.4	4.1	
HC-26T	26.5	26.5	7.4	4.3	5.8	
HC-3838	38.5	38.5	7.6	5.0	10.2	

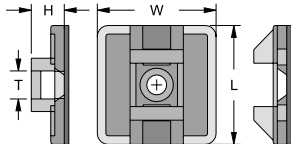

HC-26T

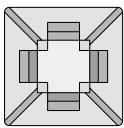

HC-100

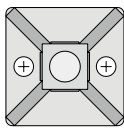

HC-101S

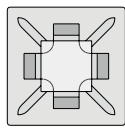

HC-101

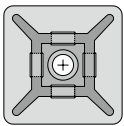

HC-101SA,102A

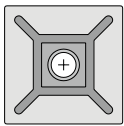

HC-102

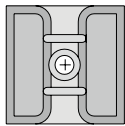

HC-103

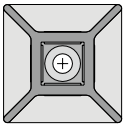

HC-25

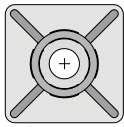

HC-19R,26R

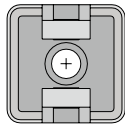

HC-18T

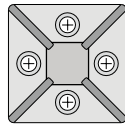

HC-3838

- Material: UL approved Nylon 66, 94V-2 with adhesive tape.
- Color : Natural, available in other colors.
- SELF-ADHESIVE TIE MOUNTS is designed to support light weight wire bundles when properly applied on any clean, smooth, grease-free surface. For heavy support, mounting hole is provided for screws.
- To apply, simply peel off liner and apply mount to surface. After that, cable ties can be inserted to secure wire bundles.
- ※HC-100-S4 4pcs on a strip (Simply peel off backing paper)
- ※HC-101S-S2 2pcs on a strip (Simply peel off backing paper)

0510 KSS SADDLE TYPE TIE MOUNT



UNIT : mm

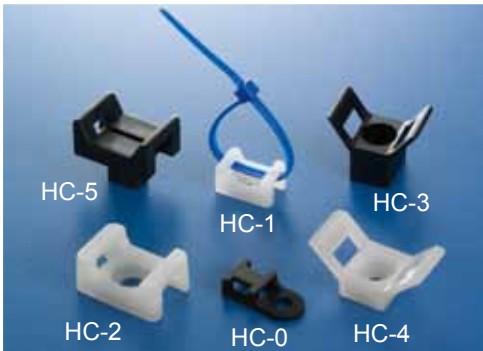

Item No.	H	L	W	T	B	Packing
HC-0	5.0	19.6	9.5	5.2	3.7	100pcs
HC-0M	5.0	19.0	9.5	5.0	4.3	
HC-0L	5.0	19.0	9.5	5.0	5.2	
HC-0R	6.2	19.1	10.0	5.4	4.2	
HC-1	7.0	15.0	10.0	5.1	3.5	
HC-1S	5.8	12.8	7.0	4.0	3.3	
HC-2S	9.8	23.0	16.0	9.0	5.0	
HC-2	9.8	23.0	16.0	9.0	6.3	
HC-2A	10.4	20.5	17.1	10.4	6.0	
HC-2L	9.8	23.0	16.0	9.0	6.5	
HC-3	17.5	23.0	13.8	9.5	5.3	
HC-4	11.6	30.0	14.7	9.3	5.0	
HC-5	10.0	21.5	16.0	7.8	5.8X9.7	

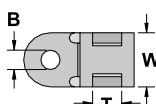

HC-0,0L,0M

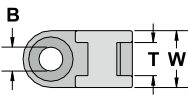

HC-0R

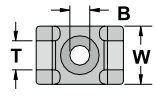

HC-1,1S,2,2A,2S,2L

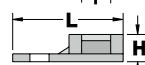

HC-3

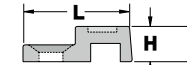

HC-4

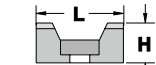

HC-5

- Material: UL approved Nylon 66, 94V-2
- Color : Natural, available in other colors.
- To apply with KSS Nylon cables ties:
HC-0: CV-075, CV-094,....,CV-280,CV-310 HC-1: CV-075, CV-094,...., CV-280,CV-310 HC-2: All applicable size
- Saddle design provide maximum stability to wire bundles.
- To apply, simply fix mount with a screw and secure wire bundles with KSS Nylon cable ties.



0511 KSS WALL PLUG MOUNT



UNIT : mm



NEW
NEW
NEW

Item No.	Dimension			Mounting Hole	Packing
	A	B	T		
CH-5	24.4	6.1	5.8	5	100pcs
CH-6	24.7	6.3	9.9	6	
CH-6A	24.7	6.0	5.8	6	
CH-7	31.5	6.3	9.8	7	
CH-8	37.5	6.3	9.7	9	
CH-8A	34.1	6.1	10.0	8	
CH-8H	36.0	5.9	9.4	9	
CH-9	36.2	13.0	9.7	9	
CH-9H	36.1	15.2	9.6	9	

- Material: UL approved Nylon 66, 94V-2
- Color : Black, available in natural or other colors.

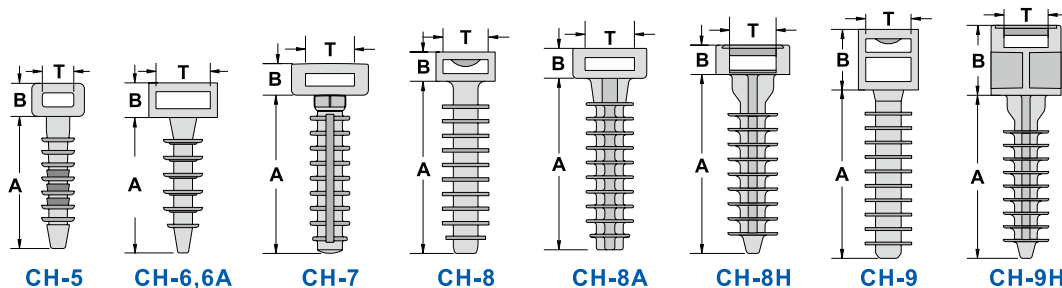

0511 KSS WALL PLUG



UNIT : mm



NEW

Item No.	Dimension		Mounting Hole	Packing
	A	B		
CWP-38	30.65	6.85	8.0	100pcs

- Material: UL approved Nylon 66, 94V-2
- Color : Black, available in natural or other colors.
- Drill a hole on the wall with 8mm deep, and screw it with using model no. PMB-145 or PMB-240 together and fix things on the wall easily.



(Refer to P.66)

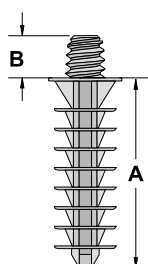

0512 KSS PUSH TIE MOUNT



UNIT : mm

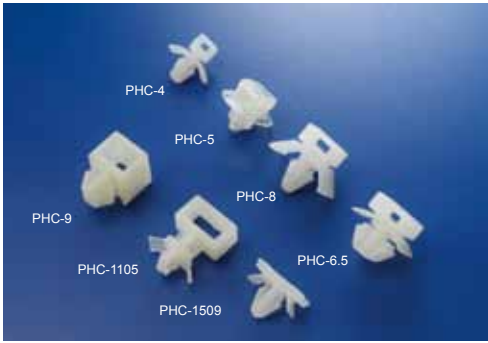

Item No.	T	Mounting Hole	Packing
PHC-4	3.8	4.8	100pcs
PHC-5	5.0	7.0	
PHC-5L	5.0	7.0	
PHC-6.5	6.5	As Figure	
PHC-8	8.1	6.2	
PHC-9	9.4	As Figure	
PHC-1105	11.0	As Figure	
PHC-1509	7.8	6.0	

- Material: UL approved Nylon 66, 94V-2
- Color : Natural, available in other colors.
- Drill hole on board to fix tie mount and then insert tie into the mount for bundling cables.

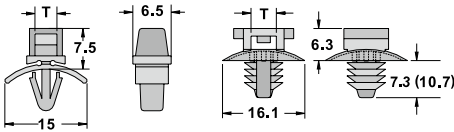

PHC-4

PHC-5, PHC-5L

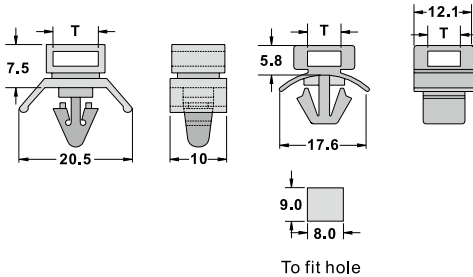

PHC-8

PHC-6.5

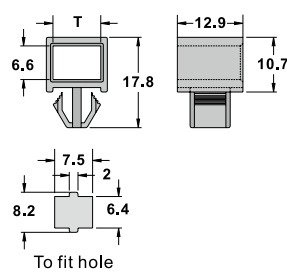

PHC-9

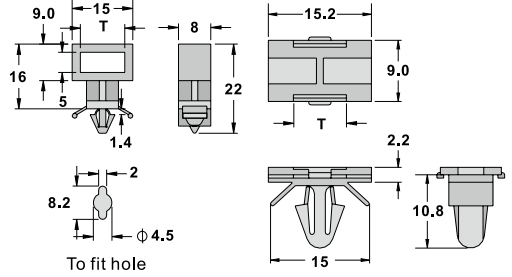

PHC-1105

PHC-1509

0513 KSS TWIN TIE DEVICE



UNIT : mm



Item No.	Dimension				Packing
	H	L	W	T	
DH-10	9.3	21.3	13.9	9.3	100pcs
DH-11	9.3	21.3	15.0	10.5	
DH-16	8.7	20.8	21.4	17.5	
DH-20	8.7	20.8	25.4	21.5	

- Material: UL approved Nylon 66, 94V-2
- Color : Black, available in natural or other colors.
- Twin tie device is ideal to connect, enables cables to be secured to posts or pipes by passing two ties through the rectangular hole.

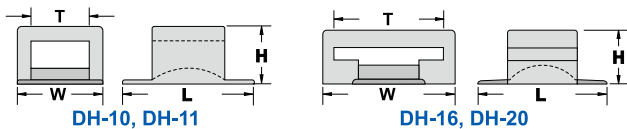

DH-10, DH-11

DH-16, DH-20



0514 KSS LADDER TYPE CABLE HOLDER



UNIT : mm



Item No.	H	Packing
LCH-60BK	60	50pcs
LCH-120BK	120	
LCH-160BK	160	

- Material: UL approved Nylon 66, 94V-2
- Color : Black
- Simply fix the holder with a screw and secure wire bundles with cable ties width of up to 4.8mm.

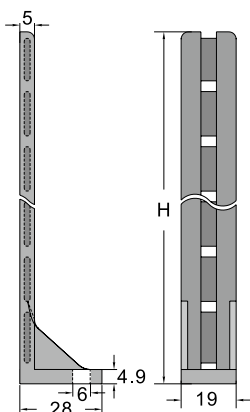

0515 KSS SELF-ADHESIVE CABLE CLAMP



UNIT : mm



Item No.	Dimension						Packing
	ØA	ØB	T1	L	W	H	
4J-S	5.5	5.0	3.0	25.8	13.4	12.2	100pcs
6J-S	7.5	5.0	3.2	28.8	13.4	14.5	
8J-S	12.0	5.3	3.0	34.8	16.5	18.5	
10J-S	14.0	5.0	3.2	36.5	16.4	19.5	
11J-S	15.0	5.0	2.7	38.2	16.0	20.3	
12J-S	17.0	4.8	3.1	41.3	15.6	25.0	

- Material: UL approved Nylon 66, 94V-2 with adhesive tape.
- Color : Black
- Backed with a high quality tape. Designed to secure wire bundles where fixing holes are impracticable. Can be quickly applied to almost any clean, smooth and grease-free surface.(Also provided with a mounting hole)

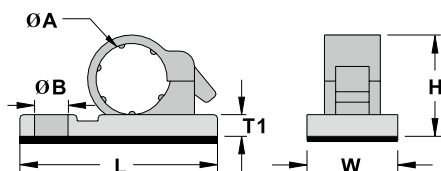

0516 KSS PUSH TIE MOUNT



UNIT : mm



Item No.	A	B	C	D	E	F	Packing
PFS-10	10.1	17.2	28.4	20.7	11.9	14.3	100pcs
PFS-15	14.9	19.3	31.8	27.1	14.0	16.3	
PFS-18	17.3	21.2	35.0	29.0	15.9	18.3	

- Material: UL approved Nylon 66, 94V-2
- Color : Grey, available in natural or other colors.

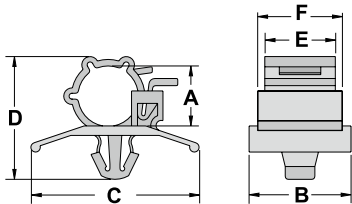

0517 KSS ADJUSTABLE CABLE CLAMP



UNIT : mm



Item No.	ØA	B	C	D	E	F	Packing
AP-0810	7.9~10.3	25.4	22.2	19.1	1.6	10.2	100pcs
AP-1013	10.0~12.5	31.8	27.8	19.1	1.6	10.2	
AP-1316	12.6~15.4	37.0	31.8	18.4	3.0	12.1	
AP-1720	16.5~20.1	42.0	37.0	25.0	3.0	12.7	
AP-2225	22.2~25.4	41.8	43.5	21.5	3.0	11.3	

- Material: UL approved Nylon 66, 94V-2 with adhesive tape.
- Color : Black
- One size of adjustable clamp can accommodate various cables that will save your cost stock.
- Easy to install, open for unlimited usage.

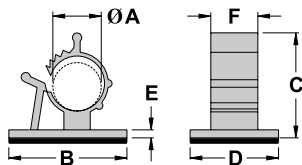

0518 KSS CABLE CLAMP



UNIT : mm



Item No.		ØA	B	C	Packing
Adhesive	Push				
TS-0607	PTS-0607	6~7	20.0	25	100pcs
TS-0708	PTS-0708	7~8	20.0	25	
TS-0910	PTS-0910	9~10	24.5	30	
TS-1214	PTS-1214	12~14	24.5	30	
TS-1618	PTS-1618	16~18	24.5	30	

- Material: UL approved Nylon 66, 94V-2
- Color : Grey, available in natural or other colors.
- Two stage lock design to accommodate different cable size in one clamp.
- Same clamp available in both "STICKY" and "PUSH MOUNT" design.

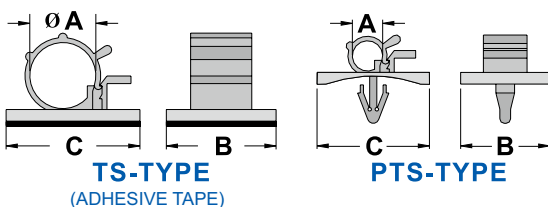

0519 KSS ADJUSTABLE CABLE CLAMP



UNIT : mm



Item No.	A	B	C	D	L	Max.Bundle Dia.	Packing
ATC-17	25.0	18.0	7.9	3.6	70	17.0	100pcs
ATC-22	30.5	21.0	12.0	3.4	90	22.0	
ATC-26	30.5	21.0	12.0	3.4	108	26.0	

- Material: UL approved Nylon 66, 94V-2 with adhesive tape.
- Color: Natural, available in other colors.
- Application: Peel off the liner and fix the clamp on the dedicated area and put the tie through the slot to secure.
- Feature: Ladder-shape tie good for adjusting the bundle loop.

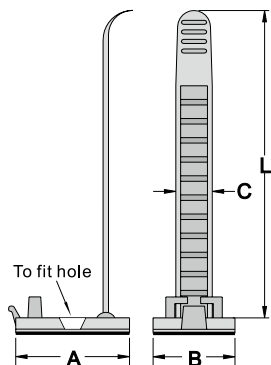

0520 KSS SELF-ADHESIVE WIRE CLIP



UNIT : mm

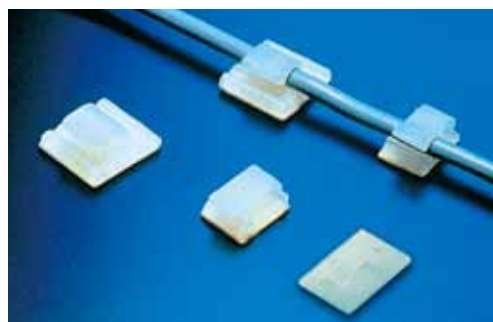

Item No.	L	L1	W	W1	H	H1	Packing
FC-1	13.0	8.0	9.5	6.5	5.2	2.8	100pcs
FC-2	16.0	4.0	15.5	9.0	6.8	4.0	
FC-2L	16.2	5.1	16.2	10.9	6.2	3.8	
FC-3	16.0	12.5	16.0	7.2	6.8	3.7	
FC-4	27.0	14.8	17.0	7.3	8.7	5.5	
※ FC-0601	19.1	6.4	12.9		2.2	0.9	
FC-1001	11.9	9.3	6.0		3.5	1.0	
FC-1206	16.0	11.9	15.8	8.9	9.0	5.8	

- Material: UL approved Nylon 66, 94V-2 with adhesive tape.
- Color: Natural, available in other colors.
- Application: Peel off the liner and secure the clip on the dedicated area and fix the wires through.
- ※ FC-0601 PRODUCED WITH UL APPROVED ABS (GREY), 94HB.

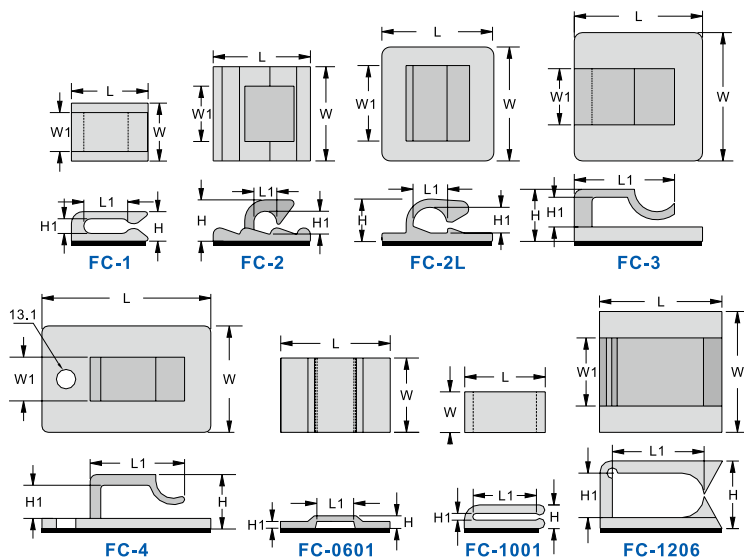

0520 KSS SELF-ADHESIVE WIRE CLIP



UNIT : mm



NEW

NEW

Item No.	L	L1	W	W1	H	H1	Packing
FC-0605	19.0	5.9	19.0	10.0	7.2	4.9	100pcs
FC-1207	25.0	11.2	25.0	12.6	10.3	7.0	
FC-1208	26.8	11.9	26.5	12.3	11.7	8.3	
FC-1813	25.6	17.8	25.5	15.8	17.2	13.3	
FC-2012	33.7	20.5	27.5	23.6	16.4	12.8	
FC-2211	33.3	22.2	28.3	18.7	15.2	11.1	

- Material: UL approved Nylon 66, 94V-2 with adhesive tape.

- Color: Natural, available in other colors.

- Application: Peel off the liner and secure the clip on the dedicated area and fix the wires through.

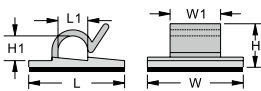
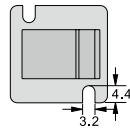

FC-0605

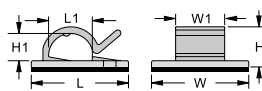

FC-1207

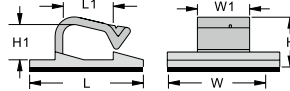

FC-1208

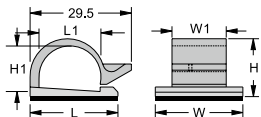

FC-1813

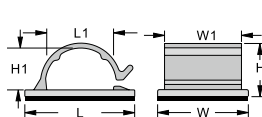

FC-2012

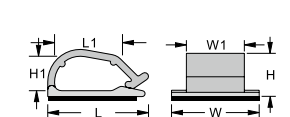

FC-2211

0521 KSS MOUNTING WIRE CLIP



UNIT : mm



Item No.	L	L1	W	W1	H	H1	Packing
MFC-1002	20.2	9.8	10.2	5.2	6	2.2	100 pcs

- Material: UL approved Nylon 66, 94V-2

- Color: Natural, available in other colors.

- Application: Quick mounting on dedicated area to fix the wires.

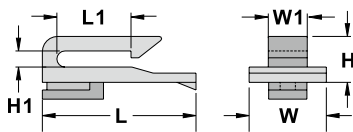

0522 KSS WIRE CLIP



UNIT : mm



Item No.	L	L1	W	W1	H	H1	Packing
FC-0903	12.8	8.9	9.8	6.6	5	2.8	100 pcs

- Material: UL approved Nylon 66, 94V-2

- Color: Natural, available in other colors.

- Application: Drill a hole on wall or board, and knock the clip to fix wires.

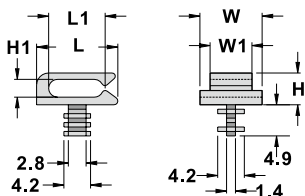

0524 KSS WIRE CLIP



UNIT : mm



Item No.	L	W	H	H1	Packing
WH-4	18.7	12.8	6.0	4.4	100 pcs

- Material: UL approved Nylon 66, 94V-2
- Color: Natural, available in other colors.
- Application: Fix wires onto the clip and use screw to fix on the chassis.

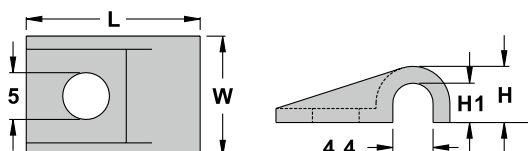

0525 KSS CATV SIDING CLIP



UNIT : mm



Item No.	D	L	W	H	Packing
CATV-1	5.5	21.1	12.8	8.7	100 pcs

- Material: UL approved Nylon 66, 94V-2 with adhesive tape.
- Color: Black
- Designed for installation of (1/4"dia.) RG-59(u) type cable.

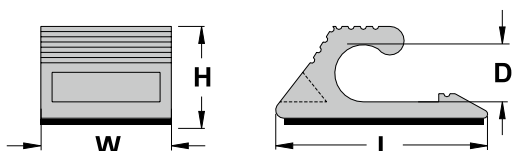

ADHESIVE TAPE

0526 KSS SELF-ADHESIVE WIRE CLIP



UNIT : mm



Item No.	L	W	H	Packing
VC-2	21.5	16.5	6.2	100 pcs

- Material: PE with adhesive tape.
- Color: White
- Application: Peel off the liner and paste onto the chassis, clip wire on to fix.

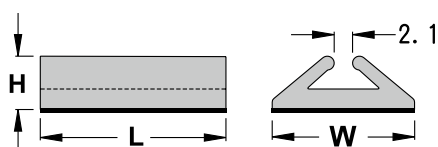

ADHESIVE TAPE

0526 KSS SELF-ADHESIVE WIRE CLIP



UNIT : mm



Item No.	L	W	H	Packing
VC-0606	8.8	18	10.7	100 pcs

- Material: UL approved Nylon 66, 94V-2 with adhesive tape.
- Color: Natural, available in other colors.
- Feature: Easy peel liner design.
- Application: Peel off the liner and paste onto the chassis, clip wire on to fix.

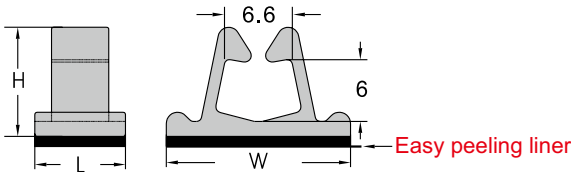

0527 KSS CABLE CLAMP



UNIT : mm



Item No.	Dimension	Packing
DCC-15	As Figure	100pcs

- Material: UL approved Nylon 66, 94V-2
- Color: Natural, available in other colors.
- Application: Fix clamp onto the chassis and insert the cable, using screw to fix the cables.

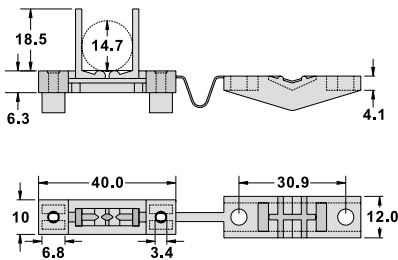

0528 KSS CABLE CLAMP



UNIT : mm



Item No.	A	B	C	Packing
RC-34	4.1	14.3	4.1	100 pcs

- Material: UL approved Nylon 66, 94V-2
- Color: Black, available in natural or other colors.
- Application: Insert cables into the clamp and lock it to fix.
- Feature: 1. To tidy the cables.
2. Suitable for 4mm cable.

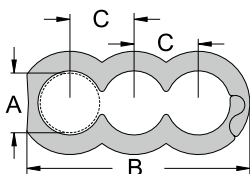

0529 KSS SELF-ADHESIVE WIRE CLIP



UNIT : mm



Item No.	A	B	C	Packing
SWC-610	11.0	9.2	8.4	100 pcs

- Material: UL approved Nylon 66, 94V-2
- Color: White
- Application: Peel off the liner and fix it on the side of table and insert wire.
- Feature: Suitable use in corner place and tidy wires with compartment design.

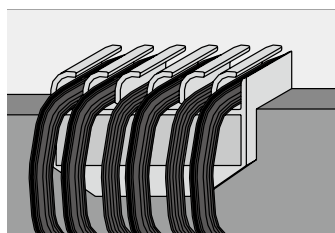
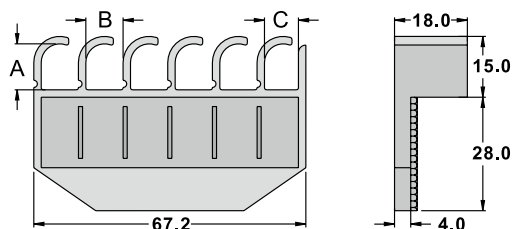

0530 KSS FLAT CABLE CLAMP



UNIT : mm

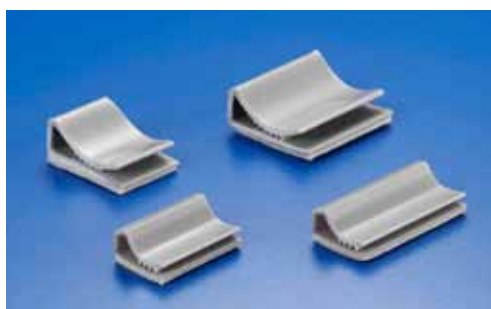

Item No.	L	W	H	Packing
FC-15	15	24	9	100 pcs
FC-20	20	24	9	
FC-25	25	24	9	
FC-28	28	24	9	
SFC-15	15	13	6	
SFC-20	20	13	6	
SFC-25	25	13	6	
SFC-28	28	13	6	

- Material: UL approved PVC, 94V-0 with adhesive tape.
- Color: Grey
- Conduct your flat cable neatly and firmly.
- Insert your cable into the clamp and your job is done.

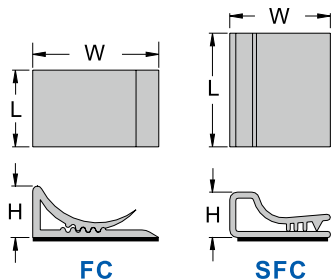

0531 KSS CABLE CLAMP



UNIT : mm

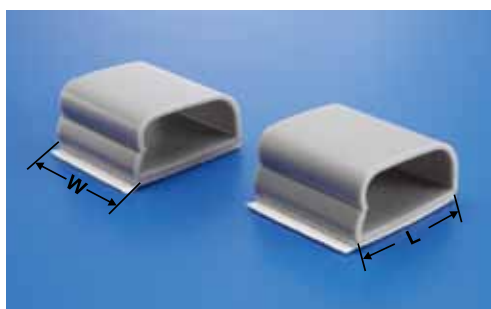

Item No.	L	W	H	H1	Packing
RCL-12	28.5	25.4	13.8	11.4	100 pcs

- Material: UL approved PVC, 94V-0 with adhesive tape.
- Color: Grey.
- Feature: Easy peel liner can help to peel off easily.
- Application: Peel off the liner, position on the flat surface then secure the wires or cables.

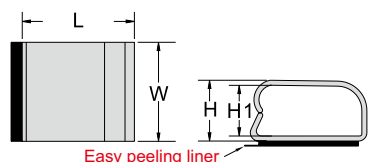

0532 KSS CABLE CLAMP



UNIT : mm



Item No.	L	W1	W2	Packing
CL-15	15	18.5	16	100pcs
CL-20	20	18.5	16	
CL-25	25	18.5	16	
CL-28	28	18.5	16	

- Material: UL approved PVC, 94V-0 with adhesive tape.
- Color : Grey.
- Application: Peel off the liner, position on the PC board surface then fix the cables.

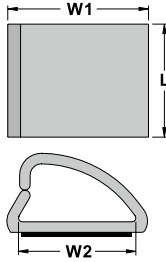

0535 KSS FLAT CABLE CLAMP



UNIT : mm



Item No.	A	B	C	D	E	F	For Cable	Packing
FC-30	32.0	6.2	45.8	19.2	14.9	2.8		100pcs
FC-40	39.5	6.2	53.3	19.2	14.8	2.6		
FC-50	63.5	6.0	77.5	19.3	14.9	2.8	50PIN	
FCT-30	31.8	11.3	45.1	18.5	16.0	16.3	30PIN	
FCT-40	54.0	11.3	67.0	15.7	12.0	16.3	40PIN	
FCT-50	65.0	11.3	78.4	18.6	15.8	16.3	50PIN	
FC-635	63.5	6.4	76.2				50PIN	
FC-776	77.6	6.4	90.0				60PIN	
FCP-315	31.4	7.6	44.7	19.1	15.2	12.4	30PIN	
FCW-50	52.2	7.0	56.8	26.2	23.0	13.0	30PIN	

- Material: UL approved Nylon 66, 94V-2
- Color: Natural, available in other colors.
- Clamp down ribbon cable by finger pressure.

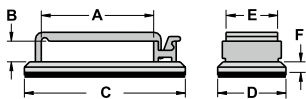
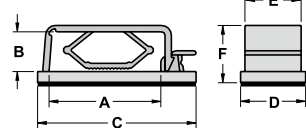
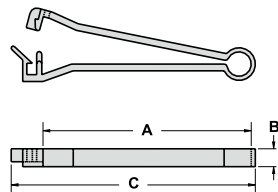
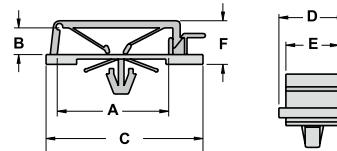
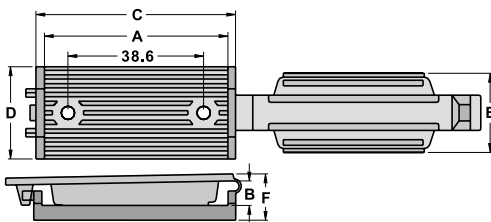
FC-30,40,50 (ADHESIVE TAPE)

FCT-30,40,50 (ADHESIVE TAPE)

FC-635,FC-776

FCP-315 (to fit 6mm hole)

FCW-50

0539 KSS CABLE CLAMP



UNIT : mm



Item No.	Dimension					Nails	Packing
	W	L	L1	H	H1		
CST-1	12.0	83.4	19.9	42.0	6.5	2.9X52	25pcs

- Material: PP, Natural with nail.
- Feature: 1. With steel nail inserted, quick installation to reduce time and cost.
- 2. Separation design to distinguish power cable and signal cables.

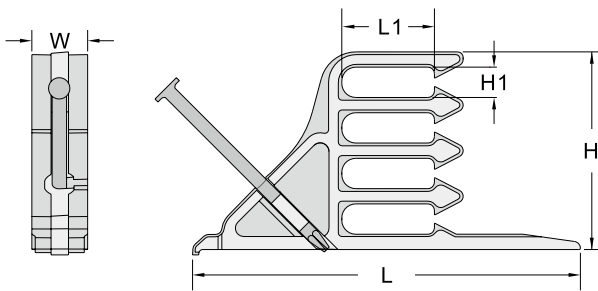

0539 KSS CABLE CLAMP



UNIT : mm



Item No.	L	W	Packing
SWD-6	87	14.2	100pcs

- Material: UL approved Nylon 66, 94V-2 with adhesive tape.
- Color: Black
- Application: Peel off the liner and position on the flat surface, open the lid to fix wires or cables.
- Feature:
 1. Design for easy installation and reusable.
 2. Separation design to distinguish power cable and signal cables.

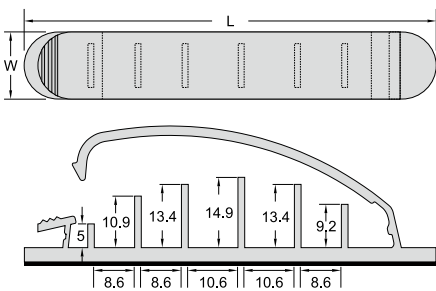

0540 KSS CABLE CLAMP



UNIT : mm

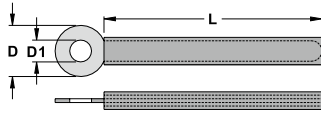

Standard design



CW10-95, CW10-115

Item No.	D	D1	L	Packing
CW3-32	7.5	3.3	32.1	100pcs
CW3-52	7.5	3.3	52.1	
CW3-60	8.0	3.6	62.1	
CW4-35	8.5	4.2	35.2	
CW4-50	8.0	4.2	52.2	
CW4-75	7.5	4.2	74.5	
CW4-78	8.0	4.2	78.5	
CW5-70	8.5	5.1	69.3	
CW6-78	10.0	6.0	78.0	
CW10-95	16.0	10.0	95.0	
CW10-115	16.0	10.0	115.0	

- Material: Steel with PVC tube.
- Application: Screw to fix on the flat surface, and bend to fix cable easily.
- Feature: PVC Tube to avoid damage on the cables, reusable, and easy for maintenance.

0545 KSS SELF-ADHESIVE WIRE CLIP



UNIT : mm

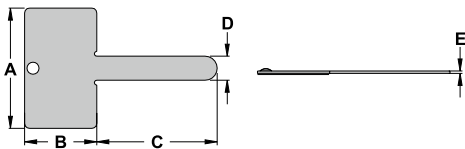
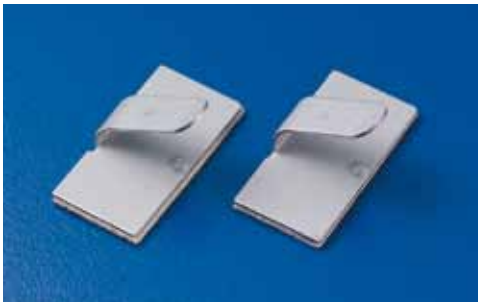

Item No.	Dimension					Packing
	A	B	C	D	E	
MWC-15	19.4	10.0	15.0	5.0	0.5	100pcs
MWC-25	25.0	15.0	25.0	5.0	0.5	

- Material: Steel with adhesive tape.
- Application: Peel off the liner and position on the flat surface. The metal part can be bent, to fix cable easily.

0550 KSS PAPER ROLL CLIP



UNIT : mm

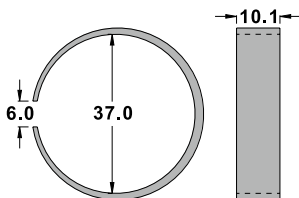

Item No.	Dimension	Packing
PRP-35	As Figure	100pcs

- Material: ABS
- Color: Natural
- Application: Tight up paper and clip on the paper roll.

0555 KSS SNAP CLAMP



UNIT : mm



Item No.	T	Ø D	Packing
SHW-13	1.8	11.9 ~ 13.5	100pcs
SHW-15		13.5 ~ 15.1	

- Material: UL approved Nylon 66, 94V-2
- Color: Natural
- Feature: 1. one size of adjustable snap clamp can accommodate various cables that will save your cost stock.
2. easy to install and fast to fix.

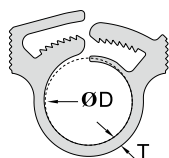

0558 KSS PIPE CLIP



UNIT : mm



Item No.	ØD	W	L	H	Packing
PPC-16	16	21.8	14.6	24.4	50pcs
PPC-20	20	26.6	14.6	28.9	
PPC-25	25	33.5	14.6	32.8	

- Material: PE
- Screw the pipe clip to the wall, and push the pipe or cable into clip to fasten.
- Can be unlimited extended (even between different items) with special buckle design on the sides. Pipe or cable is fastened to the clip in order. Easy application.

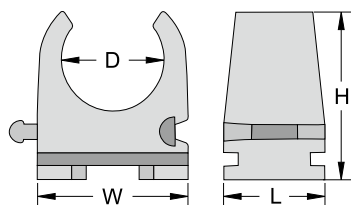



BUSHINGS CONDUIT

0604 KSS NYLON CABLE GLAND

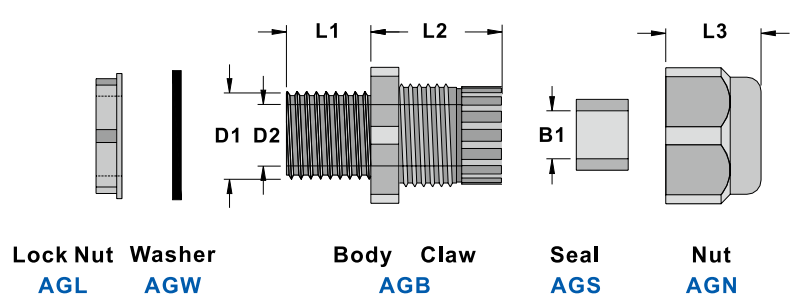

METRIC THREAD

UNIT : mm

Item No.	Thread	Mounting Hole D1	D1	D2	B1	L1	L2	L3	Cable Range	Packing
AG-12	M12x1.25	12~12.3	12	8.3	6.9	7.9	19.6	13.6	3~6.5	50pcs
AG-12L	M12x1.5	12~12.3	12	8.3	6.9	7.9	19.6	13.6	3~6.5	
AG-12H	M12x1.25	12~12.3	12	8.3	6.9	7.9	19.6	13.6	3~7.5	
NEW AG-12HL	M12x1.25	12~12.3	12	8.3	6.9	9.0	19.6	13.6	3~7.5	
AG-16	M16x1.5	16~16.3	16	10.9	10.5	15.5	23.4	16.9	5~10	
AG-16S	M16x1.5	16~16.3	16	10.9	10.5	10.0	23.4	16.9	5~10	
AG-20	M20x1.5	20~20.3	20	15.0	14.0	15.0	28.5	18.5	10~14	
AG-20S	M20x1.5	20~20.3	20	15.0	14.0	10.0	28.5	18.5	10~14	
AG-25	M25x1.5	25~25.4	25	18.6	18.4	15.2	29.4	22.3	13~18	
AG-25S	M25x1.5	25~25.4	25	18.6	18.4	10.0	29.4	22.3	13~18	
AG-32	M32x1.5	32~32.4	32	26.0	25.0	14.7	34.5	25.7	18~25	25pcs
AG-40	M40x1.5	40~40.4	40	33.7	33.0	18.4	41.7	31.3	22~32	10pcs
AG-50	M50x1.5	50~50.4	50	41.9	40.0	17.8	44.2	31.3	30~38	
AG-63	M61x1.5	61~61.4	61	55.0	44.0	18.5	44.6	32.7	34~44	
AG-63L	M63x1.5	63~63.4	63	56.6	51.5	25.4	49.0	36.8	42~50	
AG-12D	M12x1.5	12~12.3	12	7.3	6.5	8.0	19.7	12.7	3~6.5	50pcs
AG-16D	M16x1.5	16~16.3	16	10.7	10.1	8.2	23.3	16.1	5~10	
AG-20D	M20x1.5	20~20.3	20	14.1	12.4	10.0	25.0	18.1	8~12	
AG-25D	M25x1.5	25~25.4	25	18.0	17.1	10.0	30.0	20.0	11~17	25pcs
AG-32D	M32x1.5	32~32.4	32	25.7	21.2	10.0	35.4	24.1	15~21	
AG-40D	M40x1.5	40~40.4	40	32.7	28.2	10.0	39.4	27.5	20~28	10pcs
AG-50D	M50x1.5	50~50.4	50	42.2	35.3	12.0	43.4	31.6	27~35	
AG-63D	M63x1.5	63~63.4	63	55.0	42.4	16.7	46.4	33.7	32~42	

- Material : UL approved Nylon 66, 94V-2
- Color: Black, available in other colors.
- Suit a variety of applications, and diverse industries.
- Function : Mount gland to pre-drilled panel hole, use locknut to fix gland on board, insert the cables in the seal, and then tighten up the nut to hold cables in position.
- Feature : Simply and quickly fixed, high degree of the protection IP68 preventing dust and water.
- Part number AG-D series, smaller size, suit for smaller cabinet.
- Available to order the accessories separately. Follow the drawing and add the letter to the suffix part number, L for locknut, W for washer, B for gland body, S for seal, N for nut. For example, AGL-12 if you would like to only order locknut for M12x1.25

0604 KSS NYLON CABLE GLAND



NEW

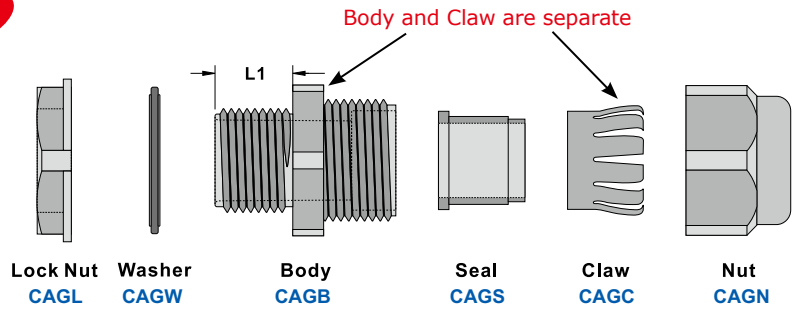

METRIC THREAD

UNIT : mm

Item No.	Thread	Mounting Hole	L1	Cable Range	Packing
CAG-12	M12x1.25	12.0~12.3	8.1	3~6.5	50pcs
CAG-16	M16x1.5	16.0~16.3	15.5	5~10	
CAG-20	M20x1.5	20.0~20.3	15.0	10~14	
CAG-25	M25x1.5	25.0~25.4	15.3	13~18	
CAG-32	M32x1.5	32.0~32.4	15.0	18~25	25pcs
CAG-40	M40x1.5	40.0~40.4	18.2	22~32	50pcs
CAG-50	M50x1.5	50.0~50.4	18.2	30~38	
CAG-63	M63x1.5	63.0~63.4	18.2	34~44	

- Material : UL approved Nylon 66, 94V-2
- Color: Black, available in other colors.
- Suit a variety of applications, and diverse industries.
- Function : Mount gland to pre-drilled panel hole, use locknut to fix gland on board, insert the cables in the seal, and then tighten up the nut to hold cables in position.
- Feature : Simply and quickly fixed, **Body and Claw are separate.**
- Available to order the accessories separately. Follow the drawing and add the letter to the suffix part number, L for locknut, W for washer, B for gland body, S for seal, C for claw, N for nut. For example, CAGL-12 if you would like to only order locknut for M12x1.25

0606 KSS NYLON CABLE GLAND

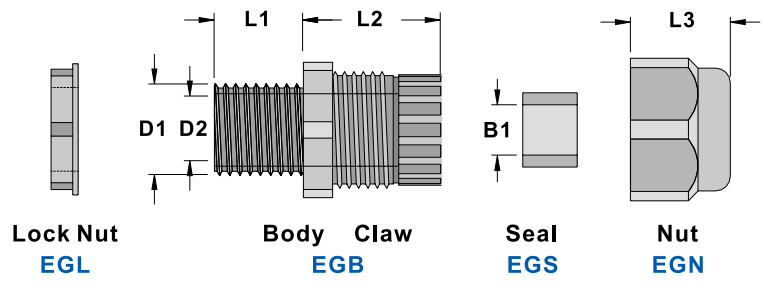

PG THREAD (DIN STANDARD) WITHOUT WASHER ※Protection : IP68 (only if the washer is assembled) UNIT : mm

Item No.	PG Thread	Mounting Hole	D1	D2	B1	L1	L2	L3	Cable Range	Packing
EG-7	PG7	12.5~12.8	12.5	8.3	6.9	7.9	20.0	13.3	3~6.5	without washer
※EG-7LS	PG7	12.5~12.8	12.5	8.3	6.9	7.9	20.0	13.3	3~6.5	
EG-9	PG9	15.2~15.5	15.2	10.5	8.0	8.2	22.0	15.1	4~8	
EG-9L	PG9	15.2~15.5	15.2	10.5	8.0	14.7	22.0	15.1	4~8	
EG-11	PG11	18.6~18.9	18.6	13.2	10.5	7.9	23.7	18.3	5~10	
EG-11L	PG11	18.6~18.9	18.6	13.2	10.5	14.9	23.7	18.3	5~10	
EG-13.5	PG13.5	20.4~20.7	20.4	15.5	12.0	8.9	24.6	18.9	6~12	
EG-13.5L	PG13.5	20.4~20.7	20.4	15.5	12.0	15.8	24.6	18.9	6~12	
EG-16	PG16	22.5~22.8	22.5	17.2	14.0	9.8	26.2	19.5	10~14	
EG-21	PG21	28.3~28.7	28.3	22.4	18.4	10.8	30.0	23.7	13~18	
EG-29	PG29	37.0~37.4	37.0	30.6	25.0	10.8	35.0	27.4	18~25	
EG-36	PG36	47.0~47.4	47.0	35.3	35.5	14.5	42.3	30.3	22~32	
EG-42	PG42	54.0~54.4	54.0	47.0	40.0	14.5	44.0	31.2	30~38	10 pcs
EG-48	PG48	59.3~59.7	59.3	46.2	46.0	16.7	42.7	31.3	34~44	

- Material: UL approved Nylon 66, 94V-2
- Color: Black, available in other colors.
- Suit a variety of applications, and diverse industries.
- Function :Mount gland to pre-drilled panel hole, use locknut to fix gland on board, insert the cables in the seal, and then tighten up the nut to hold cables in position.
- Feature : Simply and quickly fixed, high degree of the protection IP68 preventing dust and water.
- Available to order the accessories separately. Follow the drawing and add the letter to the suffix part number, L for locknut, W for washer, B for gland body, S for seal, N for nut. For example, EGL-7 if you would like to only order locknut for PG7.

※ EG-7LS has smaller nut.



0606 KSS NYLON CABLE GLAND

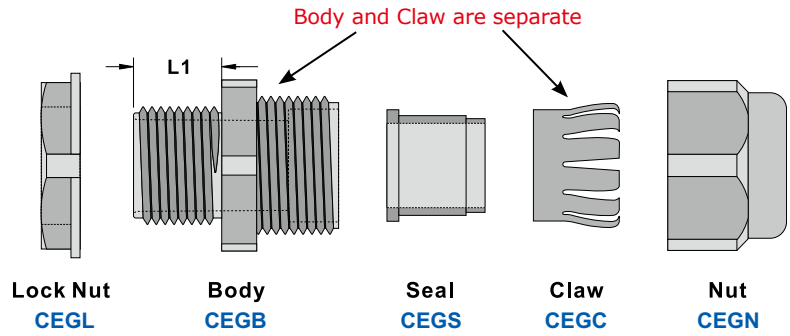

PG THREAD (DIN STANDARD) WITHOUT WASHER

UNIT : mm

Item No.	Thread	Mounting Hole	L1	Cable Range	Packing
CEG-7	PG7	12.5~12.8	8.0	3~6.5	50pcs
CEG-9	PG9	15.2~15.5	8.2	4~8	
CEG-11	PG11	18.3~18.9	8.2	5~10	
CEG-13.5	PG13.5	20.4~20.7	9.0	6~12	
CEG-16	PG16	22.5~22.8	9.9	10~14	
CEG-21	PG21	28.3~28.7	10.8	13~18	25pcs
CEG-29	PG29	37.0~37.4	10.8	18~25	
CEG-36	PG36	47.0~47.4	14.7	22~32	10pcs
CEG-42	PG42	54.0~54.4	14.7	30~38	
CEG-48	PG48	59.3~59.7	16.7	34~44	

- Material: UL approved Nylon 66, 94V-2
- Color: Black, available in other colors.
- Suit a variety of applications, and diverse industries.
- Function :Mount gland to pre-drilled panel hole, use locknut to fix gland on board, insert the cables in the seal, and then tighten up the nut to hold cables in position.
- Feature : Simply and quickly fixed, **Body and Claw are separate.**
- Available to order the accessories separately. Follow the drawing and add the letter to the suffix part number, L for locknut, W for washer, B for gland body, S for seal, C for claw, N for nut. For example, C EGL-7 if you would like to only order locknut for PG7.

0604 KSS NYLON CABLE GLAND

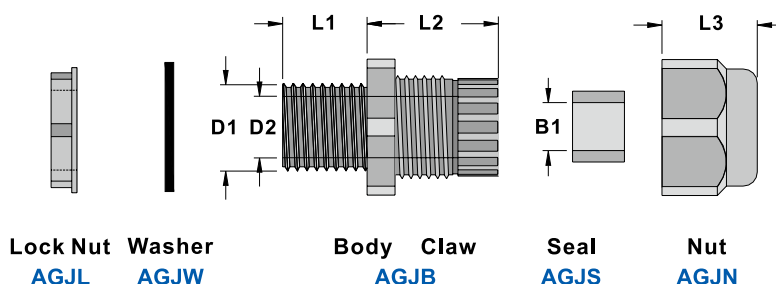

UNIT : mm

Item No.	PF Thread	Mounting Hole	D1	D2	B1	L1	L2	L3	Cable Range	Packing
AGJ-14	PF 1/4"	14~14.3	14	8.2	6.5	8.0	19.6	13.2	3~6.5	50pcs
AGJ-17	PF 3/8"	17~17.3	17	10.8	10.5	14.7	23.4	16.9	5~10	
AGJ-21	PF 1/2"	21~21.3	21	15.0	14.0	12.9	28.5	18.5	10~14	
AGJ-58	PF 5/8"	23~23.3	23	15.0	14.0	12.9	28.5	18.5	10~14	
AGJ-27	PF 3/4"	27~27.3	27	18.5	18.4	14.7	29.4	22.3	13~18	25pcs
AGJ-34	PF 1"	34~34.4	34	26.0	25.0	14.7	34.5	25.7	18~25	10pcs
AGJ-112	PF 1 1/2"	48~48.4	48	42.0	40.0	17.8	44.2	31.3	30~38	
AGJ-2	PF 2"	61~61.4	61	55.0	44.0	18.5	44.6	32.7	34~44	
AG-16F	PF 1/2" PF Thread	20.8~21.1	20.8	11.0	10.0	9.5	20.7	18.7	5~10	50pcs
AG-20F		20.8~21.1	20.8	14.6	13.0	9.3	24.1	18.5	6~13	

- Material: UL approved Nylon 66, 94V-2
- Color: Black, available in other colors.
- Function : Mount gland to pre-drilled panel hole, use locknut to fix gland on board, insert the cables in the seal, and then tighten up the nut to hold cables in position.
- Feature : Simply and quickly fixed, high degree of the protection IP68 preventing dust and water.
- Available to order the accessories separately.

Follow the drawing and add the letter to the suffix part number, L for locknut, W for washer, B for gland body, S for seal, N for nut. For example, AGJL-14 if you would like to only order locknut for PF 1/4".

※ The degree of protection is IP68 for AGJ-17 and AGJ-34.

0608 KSS NYLON CABLE GLAND

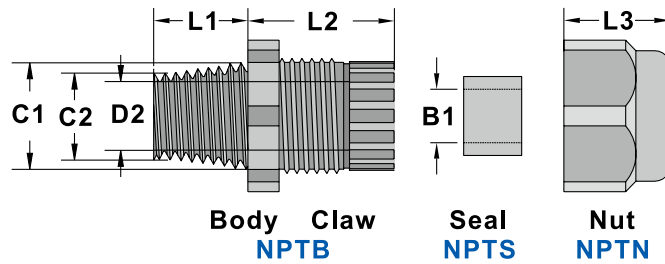

NPT THREAD

UNIT : mm

Item No.	NPT Thread	Mounting Hole	External thread		D2	B1	L1	L2	L3	Cable Range	Packing
			C1	C2							
NPT-14	1/4"-18 NPT	13.2~13.5	13.2	13.1	8.2	6.9	7.8	19.7	13.2	3-6.5	50 pcs
NPT-38	3/8"-18 NPT	16.7~17.0	16.7	16.2	10.8	10.5	14.6	23.8	16.8	5-10	
NPT-12	1/2"-14 NPT	21.2~21.5	21.2	20.8	14.9	14.0	12.9	28.4	18.7	10-14	
NPT-34	3/4"-14 NPT	26.3~26.6	26.3	25.6	18.5	18.4	14.5	29.2	22.3	13-18	
NPT-1	1"-11.5 NPT	33.2~33.6	33.2	32.9	26.0	25.0	14.9	35.0	25.7	18-25	25 pcs
NPT-114	1 1/4"-11.5 NPT	41.9~42.3	41.9	41.2	32.0	33.0	18.2	41.6	31.4	22-32	10 pcs

- Material: UL approved Nylon 66, 94V-2
- Color: Black, available in other colors.
- ※ Locknut and washer are available to be assembled upon request.

0609 KSS RIGHT ANGLE NYLON CABLE GLAND

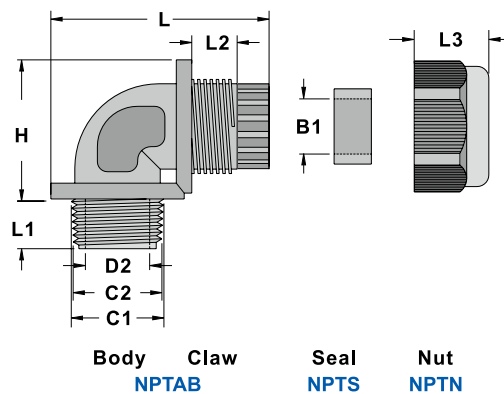

NPT THREAD

※ Lock nut and washer are available to be assembled upon request.

UNIT : mm

Item No.	NPT Thread	Mounting Hole	External thread		D2	B1	L1	L2	L3	L	H	Cable Range	Packing
			C1	C2									
NPTA-38	3/8"-18 NPT	16.7~17.0	16.7	16.2	12.0	10.5	11.7	9.85	16.7	48.5	30.0	5-9	20 pcs
NPTA-12	1/2"-14 NPT	21.2~21.5	21.2	20.8	14.0	14.0	14.7	11.75	18.4	51.6	31.2	10-13	
NPTA-34	3/4"-14 NPT	26.3~26.6	26.3	25.6	19.2	18.4	14.8	12.55	22.3	64.5	41.6	13-16	
NPTA-114	1 1/4"-11.5 NPT	41.9~42.3	41.9	41.2	31.6	33.0	18.8	16.25	31.0	85.0	53.0	22-29	10 pcs

- Material: UL approved Nylon 66, 94V-2
- Color: Black, available in other colors.
- 90° design to protect cable from breakage.

0607 KSS GLAND ADAPTOR



- Material: UL approved Nylon 66, 94V-2
- Color: Grey, available in other colors.
- To allow switching from PG external thread to metric internal thread.

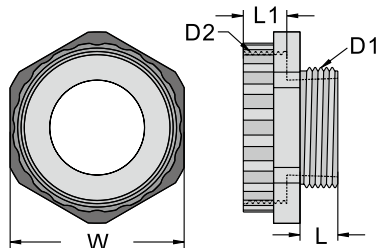

UNIT : mm

Item No.	External thread D1		Internal thread D2	L	L1	W	Packing
	PG Thread	mm					
P712GY4	PG7	12.5	M12X1.5	8	10	15.0	100pcs
P716GY4	PG7	12.5	M16X1.5	8	10	20.0	
P912GY4	PG9	15.2	M12X1.5	8	9	18.8	
P916GY4	PG9	15.2	M16X1.5	8	10	20.0	
P920GY4	PG9	15.2	M20X1.5	8	10	24.0	
P1116GY4	PG11	18.3	M16X1.5	8	9	22.0	
P1120GY4	PG11	18.3	M20X1.5	8	10	24.0	
P1316GY4	PG13.5	20.4	M16X1.5	9	9	24.0	
P1320GY4	PG13.5	20.4	M20X1.5	9	10	24.0	
P1325GY4	PG13.5	20.4	M25X1.5	9	10	30.0	
P1620GY4	PG16	22.5	M20X1.5	10	10	26.8	
P1625GY4	PG16	22.5	M25X1.5	10	10	30.0	
P2125GY4	PG21	28.3	M25X1.5	11	10	32.5	50pcs
P2132GY4	PG21	28.3	M32X1.5	11	12	36.8	
P2932GY4	PG29	37.0	M32X1.5	11	10	41.6	25pcs
P2940GY4	PG29	37.0	M40X1.5	11	11	44.8	
P3640GY4	PG36	47.0	M40X1.5	11	10	55.0	
P4250GY4	PG42	54.0	M50X1.5	11	14	55.0	
P4863GY4	PG48	49.3	M63X1.5	11	14	68.0	

0607 KSS ENLARGER GLAND



UNIT : mm



Item No.	External thread D1	Internal thread D2	L	L1	W	Packing
M1216GY4	M12X1.5	M16X1.5	8.0	8.0	20.0	100pcs
M1620GY4	M16X1.5	M20X1.5	8.0	10.5	24.0	
M2025GY4	M20X1.5	M25X1.5	8.0	10.0	29.0	
M2532GY4	M25X1.5	M32X1.5	8.0	11.5	36.0	50pcs
M3240GY4	M32X1.5	M40X1.5	10.0	11.5	46.0	25pcs
M4050GY4	M40X1.5	M50X1.5	10.0	11.5	55.0	
M5063GY4	M50X1.5	M63X1.5	10.0	11.5	68.0	

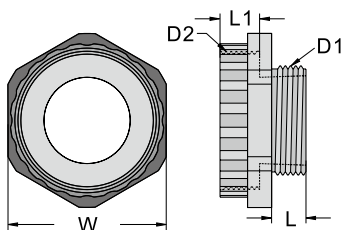

- Material: UL approved Nylon 66, 94V-2
- Color: Grey, available in other colors.
- KSS ENLARGER GLANDS with small metric external thread and large metric internal thread to allow switching from small metric external thread to large metric using.



0607 KSS REDUCTION GLAND



- Material: UL approved Nylon 66, 94V-2
- Color: Black and Grey, available in other colors.
- To allow switching from large metric external thread to small metric using.

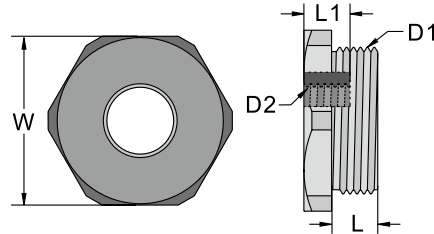

UNIT : mm

※Black

Item No.	External thread D1	Internal thread D2	L	L1	W	Packing
M2012	M20X1.5	M12X1.5	8.0	11.0	24.2	100pcs
M2016	M20X1.5	M16X1.5	8.0	12.0	24.2	
M2516	M25X1.5	M16X1.5	8.0	13.0	29.0	
M2520	M25X1.5	M20X1.5	8.0	14.0	29.0	
M3220	M32X1.5	M20X1.5	10.0	14.5	35.9	50pcs
M3225	M32X1.5	M25X1.5	10.0	15.0	35.9	
M4032	M40X1.5	M32X1.5	10.0	15.0	45.8	25pcs
M5040	M50X1.5	M40X1.5	11.5	15.0	55.0	
M6350	M63X1.5	M50X1.5	11.5	11.5	67.5	

※Grey

Item No.	External thread D1	Internal thread D2	L	L1	W	Packing
M1612GY4	M16X1.5	M12X1.5	8.0	12.0	22.0	100pcs
M2512GY4	M25X1.5	M12X1.5	8.0	13.0	28.5	
M3212GY4	M32X1.5	M12X1.5	10.0	10.0	35.5	50pcs
M3216GY4	M32X1.5	M16X1.5	10.0	14.3	35.5	
M4016GY4	M40X1.5	M16X1.5	10.0	10.0	45.5	25pcs
M4020GY4	M40X1.5	M20X1.5	10.0	10.0	45.5	
M4025GY4	M40X1.5	M25X1.5	10.0	10.0	45.5	
M5020GY4	M50X1.5	M20X1.5	12.0	12.0	54.5	
M5025GY4	M50X1.5	M25X1.5	12.0	12.0	54.5	
M5032GY4	M50X1.5	M32X1.5	12.0	12.0	54.5	
M6325GY4	M63X1.5	M25X1.5	12.0	12.0	67.5	
M6332GY4	M63X1.5	M32X1.5	12.0	12.0	67.5	
M6340GY4	M63X1.5	M40X1.5	12.0	12.0	67.5	

0601 KSS NYLON CABLE GLAND

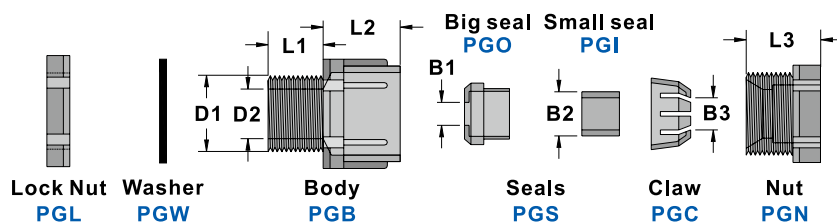

UNIT : mm

Item No.	Mounting Hole D1	D2	B1	B2	B3	L1	L2	L3	Cable Range	Packing
PG-16	16.0	11.0	4.8	6.5	10.0	12.0	17.0	16.0	5~10	50 pcs
PG-20	20.0	14.1	5.1	10.5	12.5	13.0	19.0	19.0	6~13	
PG-25	25.0	18.5	8.5	9.5	14.0	13.0	22.0	22.0	10~18	
PG-32	32.0	25.0	10.8	14.5	21.0	15.0	24.5	24.5	16~22	25 pcs
PG-40	40.0	32.4	19.5	21.5	24.0	20.5	26.5	27.3	20~27	10 pcs
PG-50	50.0	42.0	19.5	31.0	33.5	23.0	30.0	31.0	30~41	
PG-63	64.5	56.0	38.0	44.5	49.5	25.0	33.0	32.0	40~53	

- Material: UL approved Nylon 66, 94V-2
- Color: Black
- Well designed for insulation, waterproof and impact resistant. Used extensively for protection and fixation of cables in control panel and apparatus.
- Application:
 1. Mount body to pre-drilled panel hole and fix it with locking nut.
 2. Insert cables through body and then seals consequently. Finally, press them together with press nut to hold cable in position.

0602 KSS NYLON CABLE GLAND (WITH STRAIN RELIEF)



- Material: UL approved Nylon 66, 94V-2
- Color: Black, available in other colors.

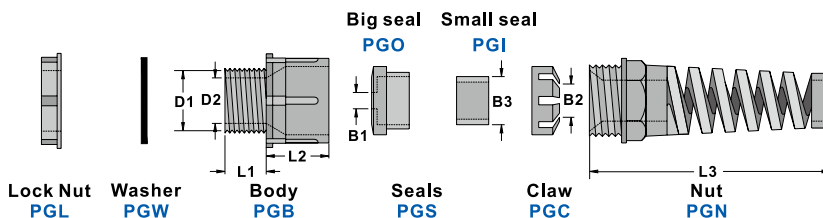

UNIT : mm

Item No.	Mounting Hole D1	Pitch	D2	B1	B2	B3	L1	L2	L3	Cable Range	Packing
PG-1610	16	1.5	11.0	4.8	6.5	10.0	12	17	62	5~10	50 pcs
PG-2013	20		14.1	5.0	10.5	12.5	13	19	78	6~13	

0603 KSS NYLON CABLE GLAND (WITH STRAIN RELIEF)



- Strain relief design protect cable from breakage / right angle bending
- Material: UL approved Nylon 66, 94V-2
 - Color: Black, available in other colors.
 - EG-SR series without washer, NPT-SR without washer and lock nut.

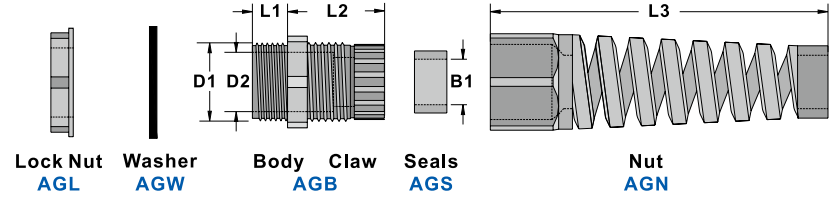

METRIC THREAD

UNIT : mm

Item No.	Thread	Mounting Hole	D1	D2	B1	L1	L2	L3	Cable Range	Packing
AG-12SR	M12x1.25	12~12.3	12.0	8.3	6.9	7.9	19.6	53.3	3~6.5	50 pcs
AG-16SR	M16x1.5	16~16.3	16.0	10.9	10.5	15.5	23.4	74.4	5~10	
AG-20SR	M20x1.5	20~20.3	20.0	15.0	14.0	15.0	28.5	96.2	10~14	
AG-25SR	M25x1.5	25~25.4	25.0	18.6	18.4	15.2	29.4	111.2	13~18	25 pcs

PG THREAD ※ Without washer

EG-7SR	PG-7	12.5~12.8	12.5	8.3	6.9	7.9	20.0	53.3	3~6.5	50 pcs
EG-9SR	PG-9	15.2~15.5	15.2	10.5	8.2	7.9	22.0	69.5	4~8	
EG-11SR	PG-11	18.6~18.9	18.6	13.2	10.5	7.9	23.7	74.9	5~10	
EG-13.5SR	PG-13.5	20.4~20.7	20.4	15.5	12.0	8.9	24.6	85.5	6~12	
EG-16SR	PG-16	22.5~22.8	22.5	17.2	14.0	9.8	26.2	96.2	10~14	25 pcs
EG-21SR	PG-21	28.3~28.7	28.3	22.4	18.4	10.8	30.0	111.2	13~18	

PF THREAD (G)

AGJ-14SR	PF1/4"	14~14.3	14.0	8.2	6.5	8.0	19.6	53.3	3~6.5	50 pcs
AGJ-17SR	PF3/8"	17~17.3	17.0	10.8	10.3	14.7	23.5	74.9	5~10	
AGJ-21SR	PF1/2"	21~21.3	21.0	14.9	14.0	12.9	28.3	96.2	10~14	
AGJ-27SR	PF3/4"	27~27.3	27.0	18.5	18.0	14.7	29.1	111.2	13~18	25 pcs

NPT THREAD ※ Without washer and lock nut

NEW NPT-14SR	1/4"-18NPT	13.2~13.5	13.2	8.2	6.9	7.8	19.7	53.3	3~6.5	50 pcs
NEW NPT-38SR	3/8"-18NPT	16.7~17.0	16.7	10.8	10.5	14.6	23.8	74.9	5~10	
NEW NPT-12SR	1/2"-14NPT	21.2~21.5	21.2	14.9	14.0	12.9	28.4	96.2	10~14	
NEW NPT-34SR	3/4"-14NPT	26.3~26.6	26.3	18.5	18.4	14.5	29.2	111.2	13~18	25 pcs

0605 KSS BUSHING GLAND



- Material: PVC
- Color: Black
- Interior diameter of each gland available in three sizes D.E.F. Cut unnecessary part(s) optionally to fit your different cable diameters.
- To be applied for fixation and protection of cables.

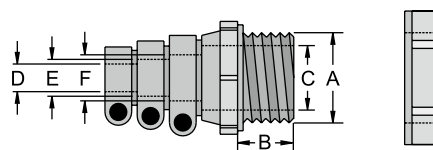

UNIT : mm

Item No.	Mounting Hole A	B	C	D	E	F	Packing
KB-1	20.5	13.0	14.0	6.0	8.0	10.0	50 pcs
KB-2	23.0	17.5	16.6	10.0	13.0	15.0	

0613 KSS MULTI-HOLE NYLON CABLE GLAND (2 HOLES)

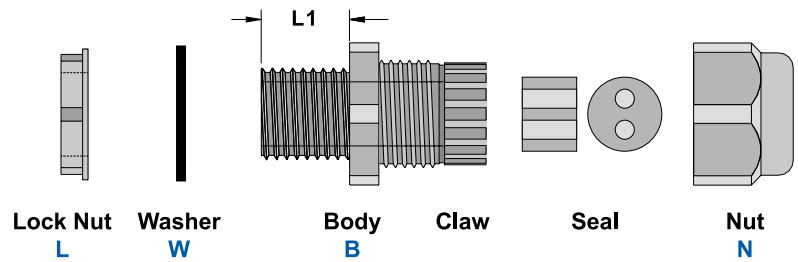

METRIC THREAD

Item No.	M Thread	Mounting Hole	L1	Cable Range	Packing
AG-12-2A	M12X1.25	12~12.3	7.9	2.0~3.1	50pcs
AG-12L-2A	M12X1.5	12~12.3	7.9	2.0~3.1	
AG-16-2A	M16X1.5	16~16.3	15.5	1.6~2.6	
AG-16-2B	M16X1.5	16~16.3	15.5	2.0~3.1	
AG-16-2C	M16X1.5	16~16.3	15.5	3.0~4.1	
AG-16S-2A	M16X1.5	16~16.3	10.0	1.6~2.6	
AG-16S-2B	M16X1.5	16~16.3	10.0	2.0~3.1	
AG-16S-2C	M16X1.5	16~16.3	10.0	3.0~4.1	
AG-20-2A	M20X1.5	20~20.3	15.0	1.6~2.6	
AG-20-2B	M20X1.5	20~20.3	15.0	2.0~3.0	
AG-20-2C	M20X1.5	20~20.3	15.0	2.5~3.5	
AG-20-2D	M20X1.5	20~20.3	15.0	3.0~4.1	
AG-20-2E	M20X1.5	20~20.3	15.0	3.3~4.3	
AG-20-2F	M20X1.5	20~20.3	15.0	3.5~5.2	
AG-20-2G	M20X1.5	20~20.3	15.0	4.3~6.1	
AG-20S-2A	M20X1.5	20~20.3	10.0	1.6~2.6	
AG-20S-2B	M20X1.5	20~20.3	10.0	2.0~3.0	
AG-20S-2C	M20X1.5	20~20.3	10.0	2.5~3.5	
AG-20S-2D	M20X1.5	20~20.3	10.0	3.0~4.1	
AG-20S-2E	M20X1.5	20~20.3	10.0	3.3~4.3	
AG-20S-2F	M20X1.5	20~20.3	10.0	3.5~5.2	
AG-20S-2G	M20X1.5	20~20.3	10.0	4.3~6.1	
AG-25-2A	M25X1.5	25~25.4	15.2	2.5~3.5	
AG-25-2B	M25X1.5	25~25.4	15.2	3.3~4.3	
AG-25-2C	M25X1.5	25~25.4	15.2	3.5~5.1	
AG-25-2D	M25X1.5	25~25.4	15.2	4.3~6.1	
AG-25-2E	M25X1.5	25~25.4	15.2	5.1~6.5	
AG-25-2F	M25X1.5	25~25.4	15.2	6.4~8.7	
AG-25S-2A	M25X1.5	25~25.4	10.0	2.5~3.5	
AG-25S-2B	M25X1.5	25~25.4	10.0	3.3~4.3	
AG-25S-2C	M25X1.5	25~25.4	10.0	3.5~5.1	
AG-25S-2D	M25X1.5	25~25.4	10.0	4.3~6.1	
AG-25S-2E	M25X1.5	25~25.4	10.0	5.1~6.5	
AG-25S-2F	M25X1.5	25~25.4	10.0	6.4~8.7	
AG-32-2A	M32X1.5	32~32.4	14.7	3.6~5.2	
AG-32-2B	M32X1.5	32~32.4	14.7	5.1~6.5	
AG-32-2C	M32X1.5	32~32.4	14.7	6.4~8.7	
AG-32-2D	M32X1.5	32~32.4	14.7	7.7~10	
AG-40-2A	M40X1.5	40~40.4	18.4	7.0~9.0	
AG-40-2B	M40X1.5	40~40.4	18.4	11~13	

PG THREAD ※ Without washer

UNIT : mm

Item No.	PG Thread	Mounting Hole	L1	Cable Range	Packing
EG-7-2A	PG7	12.5~12.8	7.9	2.0~3.1	50pcs
EG-7LS-2A	PG7	12.5~12.8	7.9	2.0~3.1	
EG-9-2A	PG9	15.2~15.5	8.2	2.0~3.1	
EG-9L-2A	PG9	15.2~15.5	14.7	2.0~3.1	
EG-11-2A	PG11	18.6~18.9	7.9	1.6~2.6	
EG-11-2B	PG11	18.6~18.9	7.9	2.0~3.1	
EG-11-2C	PG11	18.6~18.9	7.9	3.0~4.1	
EG-11L-2A	PG11	18.6~18.9	14.9	1.6~2.6	
EG-11L-2B	PG11	18.6~18.9	14.9	2.0~3.1	
EG-11L-2C	PG11	18.6~18.9	14.9	3.0~4.1	
EG-13-2A	PG13.5	20.4~20.7	8.9	3.5~5.2	
EG-13L-2A	PG13.5	20.4~20.7	15.8	3.5~5.2	
EG-16-2A	PG16	22.5~22.8	9.8	1.6~2.6	
EG-16-2B	PG16	22.5~22.8	9.8	2.0~3.0	
EG-16-2C	PG16	22.5~22.8	9.8	2.5~3.5	
EG-16-2D	PG16	22.5~22.8	9.8	3.0~4.1	
EG-16-2E	PG16	22.5~22.8	9.8	3.3~4.3	
EG-16-2F	PG16	22.5~22.8	9.8	3.5~5.2	
EG-16-2G	PG16	22.5~22.8	9.8	4.3~6.1	
EG-21-2A	PG21	28.3~28.7	10.8	2.5~3.5	
EG-21-2B	PG21	28.3~28.7	10.8	3.3~4.3	
EG-21-2C	PG21	28.3~28.7	10.8	3.5~5.1	
EG-21-2D	PG21	28.3~28.7	10.8	4.3~6.1	
EG-21-2E	PG21	28.3~28.7	10.8	5.1~6.5	
EG-21-2F	PG21	28.3~28.7	10.8	6.4~8.7	
EG-29-2A	PG29	37~37.4	10.8	3.6~5.2	
EG-29-2B	PG29	37~37.4	10.8	5.1~6.5	
EG-29-2C	PG29	37~37.4	10.8	6.4~8.7	
EG-29-2D	PG29	37~37.4	10.8	7.7~10	
EG-36-2A	PG36	47~47.4	14.5	7~9	
EG-36-2B	PG36	47~47.4	14.5	11~13	

※ washer are available to be assembled upon request.

0613 KSS MULTI-HOLE NYLON CABLE GLAND (2 HOLES)



- Material: UL approved Nylon 66, 94V-2
- Color: Black, available in other colors.
- Multi-Hole Design organizes more than one cable within a gland.

PF THREAD

Item No.	PF Thread	Mounting Hole	L1	Cable Range	Packing	
AGJ-14-2A	PF1/4"	14~14.3	8.0	2.0~3.1	50pcs	
AGJ-17-2A	PF3/8"	17~17.3	7.9	1.6~2.6		
AGJ-17-2B	PF3/8"	17~17.3	7.9	2.0~3.1		
AGJ-17-2C	PF3/8"	17~17.3	7.9	3.0~4.1		
AGJ-21-2A	PF1/2"	21~21.3	12.9	1.6~2.6		
AGJ-21-2B	PF1/2"	21~21.3	12.9	2.0~3.0		
AGJ-21-2C	PF1/2"	21~21.3	12.9	2.5~3.5		
AGJ-21-2D	PF1/2"	21~21.3	12.9	3.0~4.1		
AGJ-21-2E	PF1/2"	21~21.3	12.9	3.3~4.3		
AGJ-21-2F	PF1/2"	21~21.3	12.9	3.5~5.2		
AGJ-21-2G	PF1/2"	21~21.3	12.9	4.3~6.1		
AGJ-27-2A	PF3/4"	27~27.3	14.7	2.5~3.5		
AGJ-27-2B	PF3/4"	27~27.3	14.7	3.3~4.3		
AGJ-27-2C	PF3/4"	27~27.3	14.7	3.5~5.1		
AGJ-27-2D	PF3/4"	27~27.3	14.7	4.3~6.1		
AGJ-27-2E	PF3/4"	27~27.3	14.7	5.1~6.5		
AGJ-27-2F	PF3/4"	27~27.3	14.7	6.4~8.7		
AGJ-34-2A	PF1"	34~34.4	14.7	3.6~5.2		25pcs
AGJ-34-2B	PF1"	34~34.4	14.7	5.1~6.5		
AGJ-34-2C	PF1"	34~34.4	14.7	6.4~8.7		
AGJ-34-2D	PF1"	34~34.4	14.7	7.7~10		

NPT THREAD ※ Without washer and lock nut UNIT : mm

Item No.	NPT Thread	Mounting Hole	L1	Cable Range	Packing	
NPT-14-2A	1/4"-18 NPT	13.2~13.5	7.8	2.0~3.1	50pcs	
NPT-38-2A	3/8"-18 NPT	16.7~17.0	14.6	1.6~2.6		
NPT-38-2B	3/8"-18 NPT	16.7~17.0	14.6	2.0~3.1		
NPT-38-2C	3/8"-18 NPT	16.7~17.0	14.6	3.0~4.1		
NPT-12-2A	1/2"-14 NPT	21.2~21.5	12.9	1.6~2.6		
NPT-12-2B	1/2"-14 NPT	21.2~21.5	12.9	2.0~3.0		
NPT-12-2C	1/2"-14 NPT	21.2~21.5	12.9	2.5~3.5		
NPT-12-2D	1/2"-14 NPT	21.2~21.5	12.9	3.0~4.1		
NPT-12-2E	1/2"-14 NPT	21.2~21.5	12.9	3.3~4.3		
NPT-12-2F	1/2"-14 NPT	21.2~21.5	12.9	3.5~5.2		
NPT-12-2G	1/2"-14 NPT	21.2~21.5	12.9	4.3~6.1		
NPT-34-2A	3/4"-14 NPT	26.3~26.6	14.5	2.5~3.5		
NPT-34-2B	3/4"-14 NPT	26.3~26.6	14.5	3.3~4.3		
NPT-34-2C	3/4"-14 NPT	26.3~26.6	14.5	3.5~5.1		
NPT-34-2D	3/4"-14 NPT	26.3~26.6	14.5	4.3~6.1		
NPT-34-2E	3/4"-14 NPT	26.3~26.6	14.5	5.1~6.5		
NPT-34-2F	3/4"-14 NPT	26.3~26.6	14.5	6.4~8.7		
NPT-1-2A	1"-11.5 NPT	33.2~33.6	14.9	3.6~5.2		25pcs
NPT-1-2B	1"-11.5 NPT	33.2~33.6	14.9	5.1~6.5		
NPT-1-2C	1"-11.5 NPT	33.2~33.6	14.9	6.4~8.7		
NPT-1-2D	1"-11.5 NPT	33.2~33.6	14.9	7.7~10		
NPT-114-2A	1 1/4"-11.5 NPT	41.9~42.3	18.2	7.0~9.0	10pcs	
NPT-114-2B	1 1/4"-11.5 NPT	41.9~42.3	18.2	11~13		

※ Lock nut and washer are available to be assembled upon request.

0613 KSS MULTI-HOLE NYLON CABLE GLAND (3 HOLES)

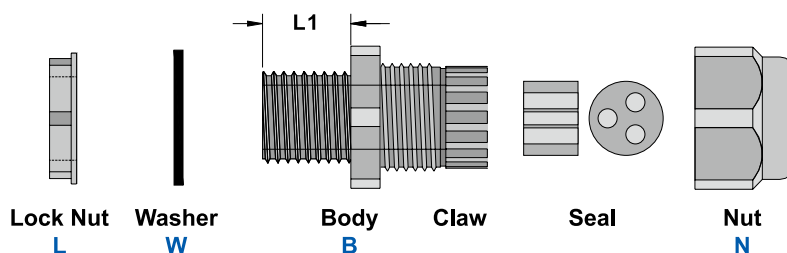

METRIC THREAD

Item No.	M Thread	Mounting Hole	L1	Cable Range	Packing	
AG-12-3A	M12X1.25	12~12.3	7.9	1.6~2.6	50pcs	
AG-12L-3A	M12X1.5	12~12.3	7.9	1.6~2.6		
AG-16-3A	M16X1.5	16~16.3	15.5	1.6~2.6		
AG-16-3B	M16X1.5	16~16.3	15.5	2.0~3.0		
AG-16-3C	M16X1.5	16~16.3	15.5	3.0~4.2		
AG-16S-3A	M16X1.5	16~16.3	10.0	1.6~2.6		
AG-16S-3B	M16X1.5	16~16.3	10.0	2.0~3.0		
AG-16S-3C	M16X1.5	16~16.3	10.0	3.0~4.2		
AG-20-3A	M20X1.5	20~20.3	15.0	2.0~3.0		
AG-20-3B	M20X1.5	20~20.3	15.0	2.6~3.6		
AG-20-3C	M20X1.5	20~20.3	15.0	3.0~4.2		
AG-20-3D	M20X1.5	20~20.3	15.0	3.5~5.0		
AG-20-3E	M20X1.5	20~20.3	15.0	3.5~5.2		
AG-20S-3A	M20X1.5	20~20.3	10.0	2.0~3.0		
AG-20S-3B	M20X1.5	20~20.3	10.0	2.6~3.6		
AG-20S-3C	M20X1.5	20~20.3	10.0	3.0~4.2		
AG-20S-3D	M20X1.5	20~20.3	10.0	3.5~5.0		
AG-20S-3E	M20X1.5	20~20.3	10.0	3.5~5.2		
AG-25-3A	M25X1.5	25~25.4	15.2	2.6~3.6		
AG-25-3B	M25X1.5	25~25.4	15.2	3.6~5.2		
AG-25-3C	M25X1.5	25~25.4	15.2	4.8~6.2		
AG-25-3D	M25X1.5	25~25.4	15.2	6.2~8.0		
AG-25S-3A	M25X1.5	25~25.4	10.0	2.6~3.6		
AG-25S-3B	M25X1.5	25~25.4	10.0	3.6~5.2		
AG-25S-3C	M25X1.5	25~25.4	10.0	4.8~6.2		
AG-25S-3D	M25X1.5	25~25.4	10.0	6.2~8.0		
AG-32-3A	M32X1.5	32~32.4	14.7	3.6~5.2		25pcs
AG-32-3B	M32X1.5	32~32.4	14.7	4.8~6.2		
AG-32-3C	M32X1.5	32~32.4	14.7	6.2~8.0		
AG-32-3D	M32X1.5	32~32.4	14.7	7.7~10		
AG-40-3A	M40X1.5	40~40.4	18.4	6.5~8.3	10pcs	
AG-40-3B	M40X1.5	40~40.4	18.4	7.7~10		

PG THREAD * Without washer

UNIT : mm

Item No.	PG Thread	Mounting Hole	L1	Cable Range	Packing	
EG-7-3A	PG7	12.5~12.8	7.9	1.6~2.6	50pcs	
EG-7LS-3A	PG7	12.5~12.8	7.9	1.6~2.6		
EG-9-3A	PG9	15.2~15.5	8.2	1.6~2.6		
EG-9L-3A	PG9	15.2~15.5	14.7	1.6~2.6		
EG-11-3A	PG11	18.6~18.9	7.9	1.6~2.6		
EG-11-3B	PG11	18.6~18.9	7.9	2.0~3.0		
EG-11-3C	PG11	18.6~18.9	7.9	3.0~4.2		
EG-11L-3A	PG11	18.6~18.9	14.9	1.6~2.6		
EG-11L-3B	PG11	18.6~18.9	14.9	2.0~3.0		
EG-11L-3C	PG11	18.6~18.9	14.9	3.0~4.2		
EG-13-3A	PG13.5	20.4~20.7	8.9	3.5~4.2		
EG-13L-3A	PG13.5	20.4~20.7	15.8	3.5~4.2		
EG-16-3A	PG16	22.5~22.8	9.8	2.0~3.0		
EG-16-3B	PG16	22.5~22.8	9.8	2.6~3.6		
EG-16-3C	PG16	22.5~22.8	9.8	3.0~4.2		
EG-16-3D	PG16	22.5~22.8	9.8	3.5~5.0		
EG-16-3E	PG16	22.5~22.8	9.8	3.5~5.2		
EG-21-3A	PG21	28.3~28.7	10.8	2.6~3.6		
EG-21-3B	PG21	28.3~28.7	10.8	3.6~5.2		
EG-21-3C	PG21	28.3~28.7	10.8	4.8~6.2		
EG-21-3D	PG21	28.3~28.7	10.8	6.2~8.0		
EG-29-3A	PG29	37~37.4	10.8	3.6~5.2		25pcs
EG-29-3B	PG29	37~37.4	10.8	4.8~6.2		
EG-29-3C	PG29	37~37.4	10.8	6.2~8.0		
EG-29-3D	PG29	37~37.4	10.8	7.7~10		
EG-36-3A	PG36	47~47.4	14.5	6.5~8.3		10pcs
EG-36-3B	PG36	47~47.4	14.5	7.7~10		

* washer are available to be assembled upon request.

0613 KSS MULTI-HOLE NYLON CABLE GLAND (3 HOLES)



- Material: UL approved Nylon 66, 94V-2
- Color: Black, available in other colors.
- Multi-Hole Design organizes more than one cable within a gland.

PF THREAD

Item No.	PF Thread	Mounting Hole	L1	Cable Range	Packing
AGJ-14-3A	PF1/4"	14~14.3	8.0	1.6~2.6	50pcs
AGJ-17-3A	PF3/8"	17~17.3	7.9	1.6~2.6	
AGJ-17-3B	PF3/8"	17~17.3	7.9	2.0~3.0	
AGJ-17-3C	PF3/8"	17~17.3	7.9	3.0~4.2	
AGJ-21-3A	PF1/2"	21~21.3	12.9	2.0~3.0	
AGJ-21-3B	PF1/2"	21~21.3	12.9	2.6~3.6	
AGJ-21-3C	PF1/2"	21~21.3	12.9	3.0~4.2	
AGJ-21-3D	PF1/2"	21~21.3	12.9	3.5~5.0	
AGJ-21-3E	PF1/2"	21~21.3	12.9	3.5~5.2	
AGJ-27-3A	PF3/4"	27~27.3	14.7	2.6~3.6	
AGJ-27-3B	PF3/4"	27~27.3	14.7	3.6~5.2	
AGJ-27-3C	PF3/4"	27~27.3	14.7	4.8~6.2	
AGJ-27-3D	PF3/4"	27~27.3	14.7	6.2~8.0	
AGJ-34-3A	PF1"	34~34.4	14.7	3.6~5.2	25pcs
AGJ-34-3B	PF1"	34~34.4	14.7	4.8~6.2	
AGJ-34-3C	PF1"	34~34.4	14.7	6.2~8.0	
AGJ-34-3D	PF1"	34~34.4	14.7	7.7~10	

NPT THREAD ※ Without washer and lock nut UNIT : mm

Item No.	NPT Thread	Mounting Hole	L1	Cable Range	Packing
NPT-14-3A	1/4"-18 NPT	13.2	7.8	1.6~2.6	50pcs
NPT-38-3A	3/8"-18 NPT	16.7	14.6	1.6~2.6	
NPT-38-3B	3/8"-18 NPT	16.7	14.6	2.0~3.0	
NPT-38-3C	3/8"-18 NPT	16.7	14.6	3.0~4.2	
NPT-12-3A	1/2"-14 NPT	21.2	12.9	2.0~3.0	
NPT-12-3B	1/2"-14 NPT	21.2	12.9	2.6~3.6	
NPT-12-3C	1/2"-14 NPT	21.2	12.9	3.0~4.2	
NPT-12-3D	1/2"-14 NPT	21.2	12.9	3.5~5.0	
NPT-12-3E	1/2"-14 NPT	21.2	12.9	3.5~5.2	
NPT-34-3A	3/4"-14 NPT	26.3	14.5	2.6~3.6	
NPT-34-3B	3/4"-14 NPT	26.3	14.5	3.6~5.2	
NPT-34-3C	3/4"-14 NPT	26.3	14.5	4.8~6.2	
NPT-34-3D	3/4"-14 NPT	26.3	14.5	6.2~8.0	
NPT-1-3A	1"-11.5 NPT	33.2	14.9	3.6~5.2	25pcs
NPT-1-3B	1"-11.5 NPT	33.2	14.9	4.8~6.2	
NPT-1-3C	1"-11.5 NPT	33.2	14.9	6.2~8.0	
NPT-1-3D	1"-11.5 NPT	33.2	14.9	7.7~10	10pcs
NPT-114-3A	1 1/4"-11.5 NPT	41.9	18.2	6.5~8.3	
NPT-114-3B	1 1/4"-11.5 NPT	41.9	18.2	7.7~10	

※ Lock nut and washer are available to be assembled upon request.

0613 KSS MULTI-HOLE NYLON CABLE GLAND (4 HOLES)

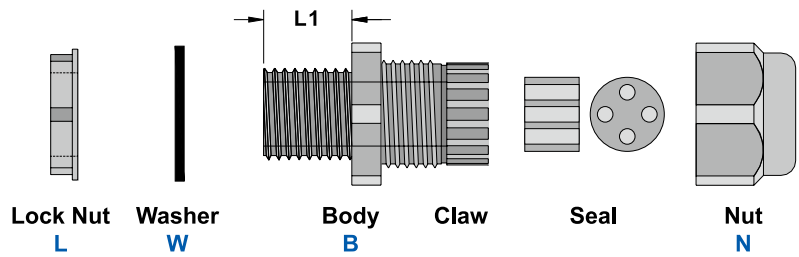

METRIC THREAD

Item No.	M Thread	Mounting Hole	L1	Cable Range	Packing
AG-12-4A	M12X1.25	12~12.3	7.9	1.3~2.3	50pcs
AG-12L-4A	M12X1.5	12~12.3	7.9	1.3~2.3	
AG-16-4A	M16X1.5	16~16.3	15.5	1.3~2.3	
AG-16-4B	M16X1.5	16~16.3	15.5	1.4~2.4	
AG-16-4C	M16X1.5	16~16.3	15.5	2.4~3.4	
AG-16S-4A	M16X1.5	16~16.3	10.0	1.3~2.3	
AG-16S-4B	M16X1.5	16~16.3	10.0	1.4~2.4	
AG-16S-4C	M16X1.5	16~16.3	10.0	2.4~3.4	
AG-20-4A	M20X1.5	20~20.3	15.0	1.4~2.4	
AG-20-4B	M20X1.5	20~20.3	15.0	1.6~2.5	
AG-20-4C	M20X1.5	20~20.3	15.0	2.4~3.4	
AG-20-4D	M20X1.5	20~20.3	15.0	2.5~3.6	
AG-20-4E	M20X1.5	20~20.3	15.0	3.0~4.2	
AG-20-4F	M20X1.5	20~20.3	15.0	3.4~4.8	
AG-20S-4A	M20X1.5	20~20.3	10.0	1.4~2.4	
AG-20S-4B	M20X1.5	20~20.3	10.0	1.6~2.5	
AG-20S-4C	M20X1.5	20~20.3	10.0	2.4~3.4	
AG-20S-4D	M20X1.5	20~20.3	10.0	2.5~3.6	
AG-20S-4E	M20X1.5	20~20.3	10.0	3.0~4.2	
AG-20S-4F	M20X1.5	20~20.3	10.0	3.4~4.8	
AG-25-4A	M25X1.5	25~25.4	15.2	1.6~2.5	25pcs
AG-25-4B	M25X1.5	25~25.4	15.2	2.0~3.1	
AG-25-4C	M25X1.5	25~25.4	15.2	2.5~3.6	
AG-25-4D	M25X1.5	25~25.4	15.2	3.0~4.1	
AG-25-4E	M25X1.5	25~25.4	15.2	3.4~4.8	
AG-25-4F	M25X1.5	25~25.4	15.2	3.8~5.2	
AG-25-4G	M25X1.5	25~25.4	15.2	5.6~7.3	
AG-25S-4A	M25X1.5	25~25.4	10.0	1.6~2.5	
AG-25S-4B	M25X1.5	25~25.4	10.0	2.0~3.1	
AG-25S-4C	M25X1.5	25~25.4	10.0	2.5~3.6	
AG-25S-4D	M25X1.5	25~25.4	10.0	3.0~4.1	
AG-25S-4E	M25X1.5	25~25.4	10.0	3.4~4.8	
AG-25S-4F	M25X1.5	25~25.4	10.0	3.8~5.2	
AG-25S-4G	M25X1.5	25~25.4	10.0	5.6~7.3	
AG-32-4A	M32X1.5	32~32.4	14.7	2.0~3.1	10pcs
AG-32-4B	M32X1.5	32~32.4	14.7	3.0~4.1	
AG-32-4C	M32X1.5	32~32.4	14.7	3.8~5.2	
AG-32-4D	M32X1.5	32~32.4	14.7	5.6~7.3	
AG-32-4E	M32X1.5	32~32.4	14.7	7.0~9.0	
AG-40-4A	M40X1.5	40~40.4	18.4	10~12	

PG THREAD * Without washer

UNIT : mm

Item No.	PG Thread	Mounting Hole	L1	Cable Range	Packing
EG-7-4A	PG7	12.5~12.8	7.9	1.3~2.3	50pcs
EG-7LS-4A	PG7	12.5~12.8	7.9	1.3~2.3	
EG-9-4A	PG9	15.2~15.5	8.2	1.3~2.3	
EG-9L-4A	PG9	15.2~15.5	14.7	1.3~2.3	
EG-11-4A	PG11	18.6~18.9	7.9	1.3~2.3	
EG-11-4B	PG11	18.6~18.9	7.9	1.4~2.4	
EG-11-4C	PG11	18.6~18.9	7.9	2.4~3.4	
EG-11L-4A	PG11	18.6~18.9	14.9	1.3~2.3	
EG-11L-4B	PG11	18.6~18.9	14.9	1.4~2.4	
EG-11L-4C	PG11	18.6~18.9	14.9	2.4~3.4	
EG-13-4A	PG13.5	20.4~20.7	8.9	3.2~4.2	
EG-13L-4A	PG13.5	20.4~20.7	15.8	3.2~4.2	
EG-16-4A	PG16	22.5~22.8	9.8	1.4~2.4	
EG-16-4B	PG16	22.5~22.8	9.8	1.6~2.5	
EG-16-4C	PG16	22.5~22.8	9.8	2.4~3.4	
EG-16-4D	PG16	22.5~22.8	9.8	2.5~3.6	
EG-16-4E	PG16	22.5~22.8	9.8	3.0~4.2	
EG-16-4F	PG16	22.5~22.8	9.8	3.4~4.8	
EG-21-4A	PG21	28.3~28.7	10.8	1.6~2.5	
EG-21-4B	PG21	28.3~28.7	10.8	2.0~3.1	
EG-21-4C	PG21	28.3~28.7	10.8	2.5~3.6	
EG-21-4D	PG21	28.3~28.7	10.8	3.0~4.1	
EG-21-4E	PG21	28.3~28.7	10.8	3.4~4.8	
EG-21-4F	PG21	28.3~28.7	10.8	3.8~5.2	
EG-21-4G	PG21	28.3~28.7	10.8	5.6~7.3	
EG-29-4A	PG29	37~37.4	10.8	2.0~3.1	25pcs
EG-29-4B	PG29	37~37.4	10.8	3.0~4.1	
EG-29-4C	PG29	37~37.4	10.8	3.8~5.2	
EG-29-4D	PG29	37~37.4	10.8	5.6~7.3	
EG-29-4E	PG29	37~37.4	10.8	7.0~9.0	
EG-36-4A	PG36	47~47.4	14.5	10~12	10pcs

* washer are available to be assembled upon request.

0613 KSS MULTI-HOLE NYLON CABLE GLAND (4 HOLES)



- Material: UL approved Nylon 66, 94V-2
- Color: Black, available in other colors.
- Multi-Hole Design organizes more than one cable within a gland.

PF THREAD

Item No.	PF Thread	Mounting Hole	L1	Cable Range	Packing	
AGJ-14-4A	PF1/4"	14~14.3	8.0	1.3~2.3	50pcs	
AGJ-17-4A	PF3/8"	17~17.3	7.9	1.3~2.3		
AGJ-17-4B	PF3/8"	17~17.3	7.9	1.4~2.4		
AGJ-17-4C	PF3/8"	17~17.3	7.9	2.4~3.4		
AGJ-21-4A	PF1/2"	21~21.3	12.9	1.4~2.4		
AGJ-21-4B	PF1/2"	21~21.3	12.9	1.6~2.5		
AGJ-21-4C	PF1/2"	21~21.3	12.9	2.4~3.4		
AGJ-21-4D	PF1/2"	21~21.3	12.9	2.5~3.6		
AGJ-21-4E	PF1/2"	21~21.3	12.9	3.0~4.2		
AGJ-21-4F	PF1/2"	21~21.3	12.9	3.4~4.8		
AGJ-27-4A	PF3/4"	27~27.3	14.7	1.6~2.5		
AGJ-27-4B	PF3/4"	27~27.3	14.7	2.0~3.1		
AGJ-27-4C	PF3/4"	27~27.3	14.7	2.5~3.6		
AGJ-27-4D	PF3/4"	27~27.3	14.7	3.0~4.1		
AGJ-27-4E	PF3/4"	27~27.3	14.7	3.4~4.8		
AGJ-27-4F	PF3/4"	27~27.3	14.7	3.8~5.2		
AGJ-27-4G	PF3/4"	27~27.3	14.7	5.6~7.3		
AGJ-34-4A	PF1"	34~34.4	14.7	2.0~3.1		25pcs
AGJ-34-4B	PF1"	34~34.4	14.7	3.0~4.1		
AGJ-34-4C	PF1"	34~34.4	14.7	3.8~5.2		
AGJ-34-4D	PF1"	34~34.4	14.7	5.6~7.3		
AGJ-34-4E	PF1"	34~34.4	14.7	7.0~9.0		

NPT THREAD ※ Without washer and lock nut UNIT : mm

Item No.	NPT Thread	Mounting Hole	L1	Cable Range	Packing	
NPT-14-4A	1/4"-18 NPT	13.2~13.5	7.8	1.3~2.3	50pcs	
NPT-38-4A	3/8"-18 NPT	16.7~17.0	14.6	1.3~2.3		
NPT-38-4B	3/8"-18 NPT	16.7~17.0	14.6	1.4~2.4		
NPT-38-4C	3/8"-18 NPT	16.7~17.0	14.6	2.4~3.4		
NPT-12-4A	1/2"-14 NPT	21.2~21.5	12.9	1.4~2.4		
NPT-12-4B	1/2"-14 NPT	21.2~21.5	12.9	1.6~2.5		
NPT-12-4C	1/2"-14 NPT	21.2~21.5	12.9	2.4~3.4		
NPT-12-4D	1/2"-14 NPT	21.2~21.5	12.9	2.5~3.6		
NPT-12-4E	1/2"-14 NPT	21.2~21.5	12.9	3.0~4.2		
NPT-12-4F	1/2"-14 NPT	21.2~21.5	12.9	3.4~4.8		
NPT-34-4A	3/4"-14 NPT	26.3~26.6	14.5	1.6~2.5		
NPT-34-4B	3/4"-14 NPT	26.3~26.6	14.5	2.0~3.1		
NPT-34-4C	3/4"-14 NPT	26.3~26.6	14.5	2.5~3.6		
NPT-34-4D	3/4"-14 NPT	26.3~26.6	14.5	3.0~4.1		
NPT-34-4E	3/4"-14 NPT	26.3~26.6	14.5	3.4~4.8		
NPT-34-4F	3/4"-14 NPT	26.3~26.6	14.5	3.8~5.2		
NPT-34-4G	3/4"-14 NPT	26.3~26.6	14.5	5.6~7.3		
NPT-1-4A	1"-11.5 NPT	33.2~33.6	14.9	2.0~3.1		25pcs
NPT-1-4B	1"-11.5 NPT	33.2~33.6	14.9	3.0~4.1		
NPT-1-4C	1"-11.5 NPT	33.2~33.6	14.9	3.8~5.2		
NPT-1-4D	1"-11.5 NPT	33.2~33.6	14.9	5.6~7.3		
NPT-1-4E	1"-11.5 NPT	33.2~33.6	14.9	7.0~9.0		
NPT-114-4A	1 1/4"-11.5 NPT	41.9~42.3	18.2	10~12	10pcs	

※ Lock nut and washer are available to be assembled upon request.

0613 KSS MULTI-HOLE NYLON CABLE GLAND (5 HOLES)

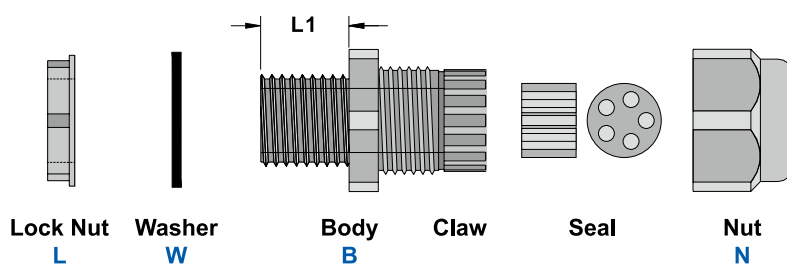

METRIC THREAD

Item No.	M Thread	Mounting Hole	L1	Cable Range	Packing
AG-16-5A	M16X1.5	16	15.5	2.0~2.8	50pcs
AG-16S-5A	M16X1.5	16	10.0	2.0~2.8	
AG-20-5A	M20X1.5	20	15.0	1.3~2.0	
AG-20-5B	M20X1.5	20	15.0	2.0~2.8	
AG-20-5C	M20X1.5	20	15.0	2.0~3.1	
AG-20-5D	M20X1.5	20	15.0	3.0~4.1	
AG-20S-5A	M20X1.5	20	10.0	1.3~2.0	
AG-20S-5B	M20X1.5	20	10.0	2.0~2.8	
AG-20S-5C	M20X1.5	20	10.0	2.0~3.1	
AG-20S-5D	M20X1.5	20	10.0	3.0~4.1	
AG-25-5A	M25X1.5	25	15.2	1.3~2.0	
AG-25-5B	M25X1.5	25	15.2	2.0~3.1	
AG-25-5C	M25X1.5	25	15.2	2.6~3.6	
AG-25-5D	M25X1.5	25	15.2	3.0~4.1	
AG-25-5E	M25X1.5	25	15.2	3.6~4.6	
AG-25-5F	M25X1.5	25	15.2	4.6~6.0	
AG-25S-5A	M25X1.5	25	10.0	1.3~2.0	
AG-25S-5B	M25X1.5	25	10.0	2.0~3.1	
AG-25S-5C	M25X1.5	25	10.0	2.6~3.6	
AG-25S-5D	M25X1.5	25	10.0	3.0~4.1	
AG-25S-5E	M25X1.5	25	10.0	3.6~4.6	
AG-25S-5F	M25X1.5	25	10.0	4.6~6.0	
AG-32-5A	M32X1.5	32	14.7	2.6~3.6	25pcs
AG-32-5B	M32X1.5	32	14.7	3.6~4.6	
AG-32-5C	M32X1.5	32	14.7	4.6~6.0	
AG-32-5D	M32X1.5	32	14.7	6.0~8.0	
AG-40-5A	M40X1.5	40	18.4	6.5~8.3	10pcs

PG THREAD ※ Without washer

UNIT : mm

Item No.	PG Thread	Mounting Hole	L1	Cable Range	Packing
EG-11-5A	PG11	18.3	7.9	2.0~2.8	50pcs
EG-11L-5A	PG11	18.3	14.9	2.0~2.8	
EG-16-5A	PG16	22.5	9.8	1.3~2.0	
EG-16-5B	PG16	22.5	9.8	2.0~2.8	
EG-16-5C	PG16	22.5	9.8	2.0~3.1	
EG-16-5D	PG16	22.5	9.8	3.0~4.1	
EG-21-5A	PG21	28.3	10.8	1.3~2.0	
EG-21-5B	PG21	28.3	10.8	2.0~3.1	
EG-21-5C	PG21	28.3	10.8	2.6~3.6	
EG-21-5D	PG21	28.3	10.8	3.0~4.1	
EG-21-5E	PG21	28.3	10.8	3.6~4.6	25pcs
EG-21-5F	PG21	28.3	10.8	4.6~6.0	
EG-29-5A	PG29	37.0	10.8	2.6~3.6	
EG-29-5B	PG29	37.0	10.8	3.6~4.6	
EG-29-5C	PG29	37.0	10.8	4.6~6.0	
EG-29-5D	PG29	37.0	10.8	6.0~8.0	10pcs
EG-36-5A	PG36	47.0	14.5	6.5~8.3	

※ washer are available to be assembled upon request.

0613 KSS MULTI-HOLE NYLON CABLE GLAND (5 HOLES)



- Material: UL approved Nylon 66, 94V-2
- Color: Black, available in other colors.
- Multi-Hole Design organizes more than one cable within a gland.

PF THREAD

Item No.	PF Thread	Mounting Hole	L1	Cable Range	Packing
AGJ-17-5A	PF3/8"	17~17.3	7.9	2.0~2.8	50pcs
AGJ-21-5A	PF1/2"	21~21.3	12.9	1.3~2.0	
AGJ-21-5B	PF1/2"	21~21.3	12.9	2.0~2.8	
AGJ-21-5C	PF1/2"	21~21.3	12.9	2.0~3.1	
AGJ-21-5D	PF1/2"	21~21.3	12.9	3.0~4.1	
AGJ-27-5A	PF3/4"	27~27.3	14.7	1.3~2.0	
AGJ-27-5B	PF3/4"	27~27.3	14.7	2.0~3.1	
AGJ-27-5C	PF3/4"	27~27.3	14.7	2.6~3.6	
AGJ-27-5D	PF3/4"	27~27.3	14.7	3.0~4.1	
AGJ-27-5E	PF3/4"	27~27.3	14.7	3.6~4.6	
AGJ-27-5F	PF3/4"	27~27.3	14.7	4.6~6.0	
AGJ-34-5A	PF1"	34~34.4	14.7	2.6~3.6	25pcs
AGJ-34-5B	PF1"	34~34.4	14.7	3.6~4.6	
AGJ-34-5C	PF1"	34~34.4	14.7	4.6~6.0	
AGJ-34-5D	PF1"	34~34.4	14.7	6.0~8.0	

NPT THREAD ※ Without washer and lock nut UNIT : mm

Item No.	NPT Thread	Mounting Hole	L1	Cable Range	Packing
NPT-38-5A	3/8"-18 NPT	16.7~17.0	14.6	2.0~2.8	50pcs
NPT-12-5A	1/2"-14 NPT	21.2~21.5	12.9	1.3~2.0	
NPT-12-5B	1/2"-14 NPT	21.2~21.5	12.9	2.0~2.8	
NPT-12-5C	1/2"-14 NPT	21.2~21.5	12.9	2.0~3.1	
NPT-12-5D	1/2"-14 NPT	21.2~21.5	12.9	3.0~4.1	
NPT-34-5A	3/4"-14 NPT	26.3~26.6	14.5	1.3~2.0	
NPT-34-5B	3/4"-14 NPT	26.3~26.6	14.5	2.0~3.1	
NPT-34-5C	3/4"-14 NPT	26.3~26.6	14.5	2.6~3.6	
NPT-34-5D	3/4"-14 NPT	26.3~26.6	14.5	3.0~4.1	
NPT-34-5E	3/4"-14 NPT	26.3~26.6	14.5	3.6~4.6	
NPT-34-5F	3/4"-14 NPT	26.3~26.6	14.5	4.6~6.0	
NPT-1-5A	1"-11.5 NPT	33.2~33.6	14.9	2.6~3.6	25pcs
NPT-1-5B	1"-11.5 NPT	33.2~33.6	14.9	3.6~4.6	
NPT-1-5C	1"-11.5 NPT	33.2~33.6	14.9	4.6~6.0	
NPT-1-5D	1"-11.5 NPT	33.2~33.6	14.9	6.0~8.0	
NPT-114-5A	1 1/4"-11.5 NPT	41.9~42.3	18.2	6.5~8.3	10pcs

※ Lock nut and washer are available to be assembled upon request.

0613 KSS MULTI-HOLE NYLON CABLE GLAND (6 HOLES)

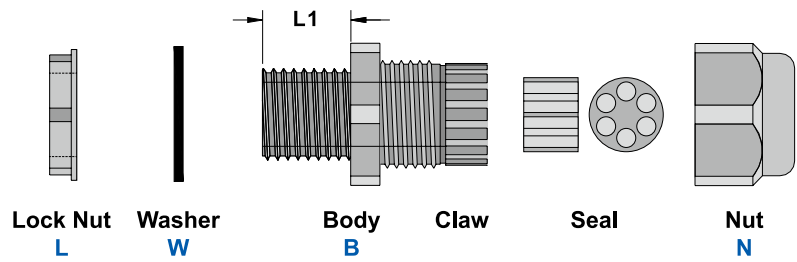

- Material: UL approved Nylon 66, 94V-2
- Color: Black, available in other colors.
- Multi-Hole Design organizes more than one cable within a gland.

METRIC THREAD

Item No.	M Thread	Mounting Hole	L1	Cable Range	Packing
AG-16-6A	M16X1.5	16~16.3	15.5	1.4~2.1	50pcs
AG-16S-6A	M16X1.5	16~16.3	10.0	1.4~2.1	
AG-20-6A	M20X1.5	20~20.3	15.0	1.3~2.0	
AG-20-6B	M20X1.5	20~20.3	15.0	2.0~3.0	
AG-20S-6A	M20X1.5	20~20.3	10.0	1.3~2.0	
AG-20S-6B	M20X1.5	20~20.3	10.0	2.0~3.0	
AG-25-6A	M25X1.5	25~25.4	15.2	1.3~2.0	
AG-25-6B	M25X1.5	25~25.4	15.2	2.0~3.0	
AG-25-6C	M25X1.5	25~25.4	15.2	2.6~3.6	
AG-25-6D	M25X1.5	25~25.4	15.2	3.6~5.2	
AG-25S-6A	M25X1.5	25~25.4	10.0	1.3~2.0	
AG-25S-6B	M25X1.5	25~25.4	10.0	2.0~3.0	
AG-25S-6C	M25X1.5	25~25.4	10.0	2.6~3.6	
AG-25S-6D	M25X1.5	25~25.4	10.0	3.6~5.2	
AG-32-6A	M32X1.5	32~32.4	14.7	2.6~3.6	25pcs
AG-32-6B	M32X1.5	32~32.4	14.7	3.6~5.2	
AG-32-6C	M32X1.5	32~32.4	14.7	5.6~7.0	

PF THREAD

UNIT : mm

Item No.	PF Thread	Mounting Hole	L1	Cable Range	Packing	
AGJ-17-6A	PF3/8"	17~17.3	7.9	1.4~2.1	50pcs	
AGJ-21-6A	PF1/2"	21~21.3	12.9	1.3~2.0		
AGJ-21-6B	PF1/2"	21~21.3	12.9	2.0~3.0		
AGJ-27-6A	PF3/4"	27~27.3	14.7	1.3~2.0		
AGJ-27-6B	PF3/4"	27~27.3	14.7	2.0~3.0		
AGJ-27-6C	PF3/4"	27~27.3	14.7	2.6~3.6		
AGJ-27-6D	PF3/4"	27~27.3	14.7	3.6~5.2		
AGJ-34-6A	PF1"	34~34.4	14.7	2.6~3.6		25pcs
AGJ-34-6B	PF1"	34~34.4	14.7	3.6~5.2		
AGJ-34-6C	PF1"	34~34.4	14.7	5.6~7.0		

PG THREAD ※ Without washer

Item No.	PG Thread	Mounting Hole	L1	Cable Range	Packing	
EG-11-6A	PG11	18.6~18.9	7.9	1.4~2.1	50pcs	
EG-11L-6A	PG11	18.6~18.9	14.9	1.4~2.1		
EG-16-6A	PG16	22.5~22.8	9.8	1.3~2.0		
EG-16-6B	PG16	22.5~22.8	9.8	2.0~3.0		
EG-21-6A	PG21	28.3~28.7	10.8	1.3~2.0		
EG-21-6B	PG21	28.3~28.7	10.8	2.0~3.0		
EG-21-6C	PG21	28.3~28.7	10.8	2.6~3.6		
EG-21-6D	PG21	28.3~28.7	10.8	3.6~5.2		
EG-29-6A	PG29	37~37.4	10.8	2.6~3.6		25pcs
EG-29-6B	PG29	37~37.4	10.8	3.6~5.2		
EG-29-6C	PG29	37~37.4	10.8	5.6~7.0		

NPT THREAD ※ Without washer and lock nut

Item No.	NPT Thread	Mounting Hole	L1	Cable Range	Packing	
NPT-38-6A	3/8"-18 NPT	16.7~17.0	14.6	1.4~2.1	50pcs	
NPT-12-6A	1/2"-14 NPT	21.2~21.5	12.9	1.3~2.0		
NPT-12-6B	1/2"-14 NPT	21.2~21.5	12.9	2.0~3.0		
NPT-34-6A	3/4"-14 NPT	26.3~26.6	14.5	1.3~2.0		
NPT-34-6B	3/4"-14 NPT	26.3~26.6	14.5	2.0~3.0		
NPT-34-6C	3/4"-14 NPT	26.3~26.6	14.5	2.6~3.6		
NPT-34-6D	3/4"-14 NPT	26.3~26.6	14.5	3.6~5.2		
NPT-1-6A	1"-11.5 NPT	33.2~33.6	14.9	2.6~3.6		25pcs
NPT-1-6B	1"-11.5 NPT	33.2~33.6	14.9	3.6~5.2		
NPT-1-6C	1"-11.5 NPT	33.2~33.6	14.9	5.6~7.0		

※ Lock nut and washer are available to be assembled upon request.

※ washer are available to be assembled upon request.

0613 KSS MULTI-HOLE NYLON CABLE GLAND (7 HOLES)

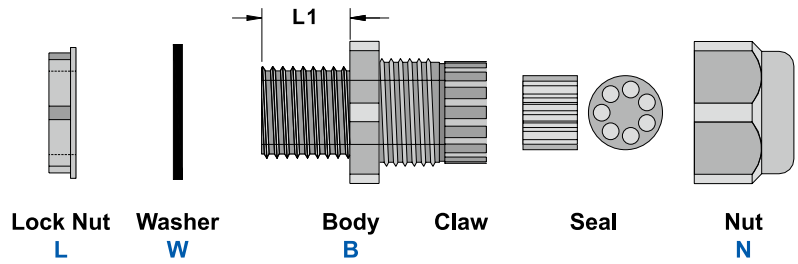

- Material: UL approved Nylon 66, 94V-2
- Color: Black, available in other colors.
- Multi-Hole Design organizes more than one cable within a gland.

METRIC THREAD

Item No.	M Thread	Mounting Hole	L1	Cable Range	Packing
AG-20-7A	M20X1.5	20~20.3	15.0	1.3~2.0	50pcs
AG-20-7B	M20X1.5	20~20.3	15.0	2.0~3.0	
AG-20S-7A	M20X1.5	20~20.3	10.0	1.3~2.0	
AG-20S-7B	M20X1.5	20~20.3	10.0	2.0~3.0	
AG-25-7A	M25X1.5	25~25.4	15.2	1.3~2.0	
AG-25-7B	M25X1.5	25~25.4	15.2	2.0~3.0	
AG-25-7C	M25X1.5	25~25.4	15.2	2.6~3.6	
AG-25S-7A	M25X1.5	25~25.4	10.0	1.3~2.0	
AG-25S-7B	M25X1.5	25~25.4	10.0	2.0~3.0	
AG-25S-7C	M25X1.5	25~25.4	10.0	2.6~3.6	
AG-32-7A	M32X1.5	32~32.4	14.7	2.6~3.6	25pcs
AG-32-7B	M32X1.5	32~32.4	14.7	4.6~6.0	

PF THREAD

UNIT : mm

Item No.	PF Thread	Mounting Hole	L1	Cable Range	Packing
AGJ-21-7A	PF1/2"	21~21.3	12.9	1.3~2.0	50pcs
AGJ-21-7B	PF1/2"	21~21.3	12.9	2.0~3.0	
AGJ-27-7A	PF3/4"	27~27.3	14.7	1.3~2.0	
AGJ-27-7B	PF3/4"	27~27.3	14.7	2.0~3.0	
AGJ-27-7C	PF3/4"	27~27.3	14.7	2.6~3.6	
AGJ-34-7A	PF1"	34~34.4	14.7	2.6~3.6	25pcs
AGJ-34-7B	PF1"	34~34.4	14.7	4.6~6.0	

PG THREAD * Without washer

Item No.	PG Thread	Mounting Hole	L1	Cable Range	Packing
EG-16-7A	PG16	22.5~22.8	9.8	1.3~2.0	50pcs
EG-16-7B	PG16	22.5~22.8	9.8	2.0~3.0	
EG-21-7A	PG21	28.3~28.7	10.8	1.3~2.0	
EG-21-7B	PG21	28.3~28.7	10.8	2.0~3.0	
EG-21-7C	PG21	28.3~28.7	10.8	2.6~3.6	25pcs
EG-29-7A	PG29	37~37.4	10.8	2.6~3.6	
EG-29-7B	PG29	37~37.4	10.8	4.6~6.0	

* washer are available to be assembled upon request.

NPT THREAD * Without washer and lock nut

Item No.	NPT Thread	Mounting Hole	L1	Cable Range	Packing
NPT-12-7A	1/2"-14 NPT	21.2~21.5	12.9	1.3~2.0	50pcs
NPT-12-7B	1/2"-14 NPT	21.2~21.5	12.9	2.0~3.0	
NPT-34-7A	3/4"-14 NPT	26.3~26.6	14.5	1.3~2.0	
NPT-34-7B	3/4"-14 NPT	26.3~26.6	14.5	2.0~3.0	
NPT-34-7C	3/4"-14 NPT	26.3~26.6	14.5	2.6~3.6	
NPT-1-7A	1"-11.5 NPT	33.2~33.6	14.9	2.6~3.6	25pcs
NPT-1-7B	1"-11.5 NPT	33.2~33.6	14.9	4.6~6.0	

* Lock nut and washer are available to be assembled upon request.

0610 KSS MICRO SWITCH COVER



UNIT : mm

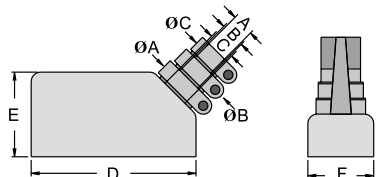

Item No.	Angle Type	ØA	ØB	ØC	D	E	F	Packing
CB-1	90°	7	9	-	49	27	19	50 pcs
CB-2	45°	7	9	11	49	27	19	

- Material: Soft PVC
- Color: Black
- Designed to protect micro switch applied on machinery. Also prevent cables from breakage.
- Available in 45° and 90° type.

0611 KSS NYLON LOCK NUT



- Material: UL approved Nylon 66, 94V-2
- Color: Black, available in other colors.

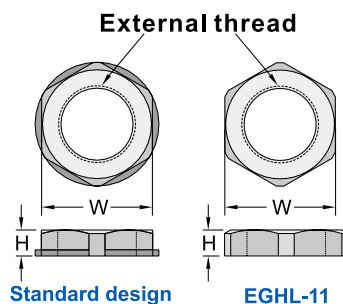

METRIC THREAD

Item No.	External thread	W	H	Packing
AGL-12	M12x1.25	17.0	5.2	50 pcs
AGL-12L	M12x1.5	17.0	5.2	
AGL-16	M16x1.5	21.8	5.2	
AGL-20	M20x1.5	26.6	6.0	
AGL-25	M25x1.5	33.0	6.7	25 pcs
AGL-32	M32x1.5	41.7	8.0	
AGL-40	M40x1.5	48.3	9.0	
AGL-50	M50x1.5	58.8	9.8	
AGL-63	M61x1.5	66.0	10.8	10 pcs
AGL-63L	M63x1.5	73.0	11.0	

PF THREAD

Item No.	External thread	W	H	Packing
AGL-20F	PF20	26.2	6.6	50 pcs
AGJL-14	PF 1/4"	17.0	5.1	50pcs
AGJL-17	PF 3/8"	22.0	5.2	
AGJL-21	PF 1/2"	27.0	6.1	
AGJL-58	PF 5/8"	26.8	6.0	
AGJL-27	PF 3/4"	33.0	7.1	25pcs
AGJL-34	PF 1"	41.6	8.1	
AGJL-112	PF 1 1/2"	58.5	9.8	10pcs
AGJL-2	PF 2"	72.3	10.8	

PG THREAD

UNIT : mm

Item No.	External thread	W	H	Packing
EGL-7	PG7	19.1	5.1	50 pcs
EGL-7LS	PG7	15.6	5.1	
EGL-9	PG9	21.0	5.1	
EGL-11	PG11	24.0	5.1	
EGL-13.5	PG13.5	27.0	6.1	
EGL-16	PG16	30.0	6.1	
EGL-21	PG21	36.0	7.1	
EGL-29	PG29	46.2	8.0	
EGL-36	PG36	58.3	7.8	25 pcs
EGL-42	PG42	65.0	7.8	10 pcs
EGL-48	PG48	69.5	7.8	
EGHL-11	PG11	23.9	5.2	50 pcs

NPT THREAD

Item No.	External thread	W	H	Packing
NPTL-14	NPT 1/4"	17.0	5.1	50 pcs
NPTL-38	NPT 3/8"	22.0	5.2	
NPTL-12	NPT 1/2"	27.0	6.1	
NPTL-34	NPT 3/4"	33.0	7.1	
NPTL-1	NPT 1"	42.2	8.1	25 pcs
NPTL-114	NPT 1 1/4"	48.8	9.0	10 pcs

0612 KSS NYLON CABLE GLAND SEALING PLUG



UNIT : mm

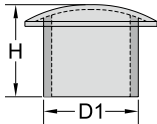
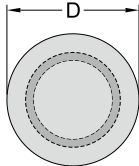

Item No.	D	D1	H	Suitable for cable gland	Packing
BPA-060	10.2	6.0	15.5	AG-12, EG-7, AGJ-14, NPT-14	50pcs
BPA-095	15.6	9.5	15.5	AG-16, EG-11, AGJ-17, NPT-38	
BPA-135	19.6	13.5	16.5	AG-20, EG-16, AGJ-21, NPT-12	
BPA-175	24.4	17.5	17.0	AG-25, EG-21, AGJ-27, NPT-34	25pcs
BPA-245	32.5	24.5	17.2	AG-32, EG-29, AGJ-34, NPT-1	10pcs
BPA-315	41.5	31.5	17.6	AG-40, NPT-114	
BPA-389	47.2	38.9	17.6	AG-50, EG-36	
BPA-435	52.5	43.5	18.6	AG-63	

- Material: UL approved Nylon 66, 94V-2
- Color: Black
- Insert into the cable gland before any assembly to avoid dust and water

0614 KSS WASHER



- Material: PVC
- Color: Black
- Function: To be used with cable gland to get effect of non-slip, seamless and water-resistant.

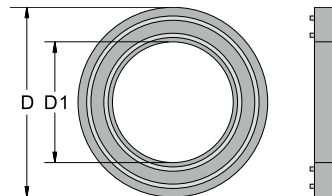

UNIT : mm

Item No.	I.D. D1	O.D. D	Packing
AGW-12	10.5	17	50pcs
AGW-16	16	24	
AGW-20	20	28	
AGW-25	25	35	
AGW-32	32	44	25pcs
AGW-40	40	52	10pcs
AGW-50	50	65	
AGW-63	58.5	69.5	
AGW-63L	62	81.4	
AGJW-14	13	18	50pcs
AGJW-17	16	24	
AGJW-21	20	28	
AGJW-27	25	35	
AGJW-34	32	44	25pcs
AGJW-112	50	65	10pcs
AGJW-2	58.5	69.5	
AGW-20F	20	28	50pcs

Item No.	I.D. D1	O.D. D	Packing
EGW-7	10.5	17	50pcs
EGW-9	15	22	
EGW-11	18	26	
EGW-13.5	20	28	
EGW-16	22.5	29.5	
EGW-21	28	35.5	
EGW-29	37	45	
EGW-36	47	54	
EGW-42	54	65	10pcs
EGW-48	58.5	69.5	
NPTW-14	13	18	50pcs
NPTW-38	16	24	
NPTW-12	20	28	
NPTW-34	25	35	
NPTW-1	32	44	25pcs
NPTW-114	40	52	10pcs

0613 KSS MULTI-HOLE SEAL



NEW

- Material: TPE
- Function: To be used with cable gland and gather various cables into it.

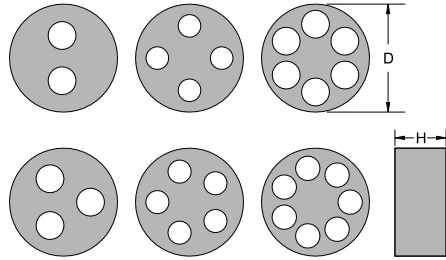

UNIT : mm

Item No.	Cable Range	O.D. D	H	Holes	Suitable Cable Gland	Packing	Item No.	Cable Range	O.D. D	H	Holes	Suitable Cable Gland	Packing	
MH9-2A	2.0~3.1	9.0	7.3	2	AG-12、EG-7、AGJ-14、NPT-14	50pcs	MH18-5A	1.3~2.0	17.5	9.0	5	AG-20、EG-16、AGJ-21、NPT-12	50pcs	
MH9-3A	1.6~2.6			3			MH18-5B	2.0~2.8						6
MH9-4A	1.3~2.3			4				MH18-5C						
MH11-2A	2.0~3.1	2	EG-9	MH18-5D	3.0~4.1									
MH11-3A	1.6~2.6	3			MH18-6A		1.3~2.0							
MH11-4A	1.3~2.3	4					MH18-6B	2.0~3.0						
MH14-2A	1.6~2.6	14.0	9.2	AG-16、EG-11、AGJ-17、NPT-38				MH18-7A			1.3~2.0			22.8
MH14-2B	2.0~3.1				2			MH23-2A	2.5~3.5					
MH14-2C	3.0~4.1				3		MH23-2B		3.3~4.3					
MH14-3A	1.6~2.6								4	MH23-2C	3.5~5.1			
MH14-3B	2.0~3.0							5			MH23-2D	4.3~6.1		
MH14-3C	3.0~4.2				6		MH23-2E					5.1~6.5		
MH14-4A	1.3~2.3								7	MH23-2F		6.4~8.7		
MH14-4B	1.4~2.4							3			MH23-3A	2.6~3.6		
MH14-4C	2.4~3.4				4		MH23-3B					3.6~5.2		
MH14-5A	2.0~2.8								5	MH23-3C		4.8~6.2		
MH14-6A	1.4~2.1							6			MH23-3D	6.2~8.0		
MH16-2A	3.5~5.2				2		MH23-4A					1.6~2.5		
MH16-3A	3.5~5.0				3	MH23-4B			2.0~3.1					
MH16-4A	3.2~4.0				4			MH23-4C	2.5~3.6					
MH18-2A	1.6~2.6	17.5	9.0	AG-20、EG-16、AGJ-21、NPT-12	MH23-4D		3.0~4.1		5					
MH18-2B	2.0~3.0				2	MH23-4E	3.4~4.8							
MH18-2C	2.5~3.5						3	MH23-4F		3.8~5.2				
MH18-2D	3.0~4.1									4	MH23-4G	5.6~7.3		
MH18-2E	3.3~4.3				5	MH23-5A						1.3~2.0		
MH18-2F	3.5~5.2						6	MH23-5B				2.0~3.1		
MH18-2G	4.3~6.1									7	MH23-5C	2.6~3.6		
MH18-3A	2.0~3.0				3	MH23-5D			3.0~4.1					
MH18-3B	2.6~3.6						4	MH23-5E	3.6~4.6					
MH18-3C	3.0~4.2								5	MH23-5F	4.6~6.0			
MH18-3D	3.5~5.0				6	MH23-6A					1.3~2.0			
MH18-3E	3.5~5.2						7	MH23-6B			2.0~3.0			
MH18-4A	1.4~2.4								3	MH23-6C	2.6~3.6			
MH18-4B	1.6~2.5				4	MH23-6D					3.6~5.2			
MH18-4C	2.4~3.4	5	MH23-7A	1.3~2.0										
MH18-4D	2.5~3.6			6			MH23-7B	2.0~3.0						
MH18-4E	3.0~4.2				7	MH23-7C		2.6~3.6						
MH18-4F	3.4~4.8	4												

0613 KSS MULTI-HOLE SEAL



UNIT : mm

Item No.	Cable Range	O.D. D	H	Holes	Suitable Cable Gland	Packing	Item No.	Cable Range	O.D. D	H	Holes	Suitable Cable Gland	Packing
MH30-2A	3.6~5.2	30.4	14.4	2	AG-32、 EG-29、 AGJ-34、 NPT-1	25pcs	MH30-6A	2.6~3.6	30.4	14.4	6	AG-32、 EG-29、 AGJ-34、 NPT-1	25pcs
MH30-2B	5.1~6.5						MH30-6B	3.6~5.2					
MH30-2C	6.4~8.7						MH30-6C	5.6~7.0					
MH30-2D	7.7~10						MH30-7A	2.6~3.6					
MH30-3A	3.6~5.2						MH30-7B	4.6~6.0					
MH30-3B	4.8~6.2			39.0			8.3	2	MH39-2A	7.0~9.0	AG-40、 NPT-114	10pcs	
MH30-3C	6.2~8.0								MH39-2B	11~13			
MH30-3D	7.7~10								MH39-3A	6.5~8.3			
MH30-4A	2.0~3.1								MH39-3B	7.7~10			
MH30-4B	3.0~4.1								MH39-4A	10~12			
MH30-4C	3.8~5.2			41.8			8.3	3	MH39-5A	6.5~8.3	EG-36	10pcs	
MH30-4D	5.6~7.3								MH42-2A	7.0~9.0			
MH30-4E	7.0~9.0								MH42-2B	11~13			
MH30-5A	2.6~3.6								MH42-3A	6.5~8.3			
MH30-5B	3.6~4.6								MH42-3B	7.7~10			
MH30-5C	4.6~6.0	41.8	8.3	4	MH42-4A	10~12	EG-36	10pcs					
MH30-5D	6.0~8.0				MH42-5A	6.5~8.3							

0613 KSS FLAT-HOLE SEAL



- Material: TPE
- Function: To be used with cable gland, for flat cable.
- Ordering information: While ordering cable gland with flat seal, please add the letter to the suffix part number of cable gland.
- For example:
 AG-12 (CABLE GLAND) + MH9-FA (FLAT SEAL) = AG-12-FA
 NPT-34 (CABLE GLAND) + MH23-FD (FLAT SEAL) = NPT-34-FD
 EG-36 (CABLE GLAND) + MH39-FB (FLAT SEAL) = EG-36-FB

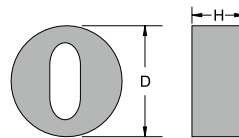

Item No.	Cable Range	O.D. D	H	Suitable Cable Gland	Packing
MH9-FA	6.9X2.3	9.0	7.3	AG-12、 EG-7、 AGJ-14、 NPT-14	50pcs
MH11-FA	6.9X2.3	11.0	8.0	EG-9	
MH14-FA	6.9X2.3	14.0	9.2	AG-16、 EG-11、 AGJ-17、 NPT-38	
MH14-FB	9.8X6				
MH16-FA	11.3X5	16.0	8.4	EG-13.5	
MH18-FA	9.8X6	17.5	9.0	AG-20、 EG-16、 AGJ-21、 NPT-12	
MH18-FB	11.3X5				
MH18-FC	11.8X6.5				
MH18-FD	11.8X7				
MH18-FE	13.8X6				
MH18-FF	13.8X7				

Item No.	Cable Range	O.D. D	H	Suitable Cable Gland	Packing
MH23-FA	11.8X6.5	22.8	11.2	AG-25、 EG-21、 AGJ-27、 NPT-34	50pcs
MH23-FB	11.8X7				
MH23-FC	13.8X6				
MH23-FD	13.8x7				
MH30-FA	13.8x6	30.4	14.4	AG-32、 EG-29、 AGJ-34、 NPT-1	25pcs
MH30-FB	13.8x7				
MH30-FC	21.8X8				
MH39-FA	28.3X10	39.0	8.3	AG-40、 NPT-114	10pcs
MH39-FB	28.8X5.5				
MH42-FA	28.3X5.5	41.8	8.3	EG-36	10pcs
MH42-FB	28.5X10				

0615 KSS FLEXIBLE CONDUIT ADAPTOR

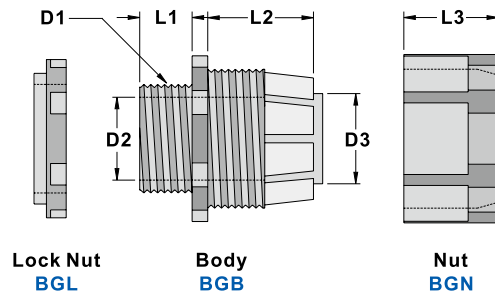

UNIT : mm

Item No.	D1	D2	D3	L1	L2	L3	Suitable Conduit	Packing
BG-10	14.4	6.3	7.5	9.7	18.5	15.9	BG-10P	50 pcs
NEW BG-14	18.0	11.0	10.5	10.0	17.9	15.7	BG-14P	
BG-16	18.0	11.0	10.8	10.0	17.9	15.7	BG-16P	
BG-18	16.0	11.1	13.3	9.7	18.6	15.9	BG-18P	
BG-20	21.0	15.0	14.7	10.0	17.7	16.0	BG-20P	
BG-22	20.0	15.4	17.2	9.8	17.6	16.3	BG-22P	
NEW BG-25	25.0	18.9	18.9	11.4	23.6	20.6	BG-25P	
BG-26	25.0	18.9	19.8	11.4	23.6	20.6	BG-26P	25 pcs
BG-32	33.0	26.0	24.3	12.0	22.8	20.6	BG-32P	
BG-34	32.0	26.8	28.6	11.3	23.3	20.7	BG-34P	
BG-40	40.0	31.5	31.6	11.3	23.6	20.7	BG-40P	
BG-42	40.0	32.7	34.8	11.5	23.3	20.8	BG-42P	10 pcs
BG-48	46.0	37.5	40.5	12.6	22.3	20.7	BG-48P	
BG-50	46.0	37.5	39.5	12.6	21.6	20.7	BG-50P	

- Material: UL approved Nylon 66, 94V-2
 - Color: Grey
 - Constructed of three parts to fix flexible conduit in control panel, machinery and apparatus.
 - Application
 1. Mount body to pre-drilled panel hole.
 2. Insert conduit through nut.
 3. Insert conduit to claw and fix it with nut to complete works.
- ※ Available in LDPE material upon request.

0615 KSS FLEXIBLE CONDUIT ADAPTOR



UNIT : mm



Item No.	TYPE	Suitable Conduit	Packing
FAM-18	Conduit to conduit connector	BG-18P	20 pcs
FAM-22		BG-22P	
FAM-26		BG-26P	
FAM-34		BG-34P	
FAB-18	Conduit to junction box connector	BG-18P	
FAB-22		BG-22P	
FAB-26		BG-26P	
FAB-34		BG-34P	
FAP-18	Conduit to PVC pipe connector	BG-18P	
FAP-22		BG-22P	
FAP-26		BG-26P	
FAP-34		BG-34P	

- Material: UL approved ABS, 94HB
- Color: Grey

0616 KSS EASY TYPE FLEXIBLE CONDUIT ADAPTOR



UNIT : mm

PATENT

Item No.		Mounting Hole	Suitable Conduit	Packing
Grey	Black			
BGQ-16	BGQ-16BK	16.0	BG-16P	50 pcs (with screw nut)
BGQ-18	BGQ-18BK	17.0	BG-18P	
BGQ-20	BGQ-20BK	20.0	BG-20P	
BGQ-22	BGQ-22BK	20.6	BG-22P	
BGQ-25	BGQ-25BK	25.0	BG-25P	
BGQ-26	BGQ-26BK	24.0	BG-26P	
BGQ-32	BGQ-32BK	32.0	BG-32P	25 pcs (with screw nut)
BGQ-34	BGQ-34BK	32.5	BG-34P	

- Material: UL approved Nylon 66, 94V-2
- Color: Black / Grey
- Feature : One piece design, easy and faster installation without tool.

INSTALL INSTRUCTION

STEP1
Insert the conduit into the adaptor.

STEP2
Push lock out.

STEP3
Turn it around for locking.

0620 KSS FLEXIBLE CONDUIT



- Material: PE (EVA available)
- For running cable protection in Electrical/Machinery/Building Harness wiring.
- Flexible body facilitate your corner / elbow wiring.

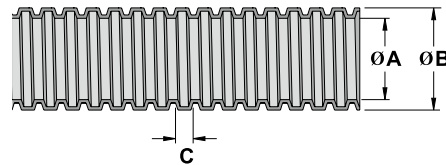

- Close design

UNIT : mm

Item No.	Ø A	Ø B	C	Suitable Adaptor	Packing
BG-10P	7.4 ± 0.4	10.2 ± 0.4	2.64	BG-10	300 M
BG-14P	10.7 ± 0.4	14.1 ± 0.4	2.04	BG-14	100 M
BG-16P	10.7 ± 0.4	16.0 ± 0.4	3.3	BG-16, BGQ-16	
BG-18P	13.8 ± 0.4	17.5 ± 0.4	3.1	BG-18, BGQ-18	
BG-20P	14.1 ± 0.4	20.0 ± 0.4	3.7	BG-20, BGQ-20	
BG-22P	17.2 ± 0.4	22.0 ± 0.4	3.1	BG-22, BGQ-22	
BG-25P	18.3 ± 0.4	25.0 ± 0.4	4.1	BG-25, BGQ-25	
BG-26P	21.2 ± 0.4	25.8 ± 0.4	3.1	BG-26, BGQ-26	50 M
BG-32P	24.3 ± 0.4	32.0 ± 0.4	3.61	BG-32, BGQ-32	
BG-34P	28.7 ± 0.4	34.0 ± 0.4	3.1	BG-34, BGQ-34	
BG-40P	31.2 ± 0.4	40.0 ± 0.4	4.12	BG-40	
BG-42P	34.9 ± 0.4	42.0 ± 0.4	3.1	BG-42	
BG-48P	40.0 ± 0.5	48.0 ± 0.5	2.85	BG-48	
BG-50P	39.6 ± 0.5	50.0 ± 0.5	4.85	BG-50	30 M
BG-55P	47.5 ± 0.4	54.5 ± 0.5	2.0		
※ BG-60P	52.0 ± 0.5	60.0 ± 0.5	5.8		
※ BG-76P	62.0 ± 0.5	76.0 ± 0.5	5.8		

※ Please call if required as it is under developing now.

0616 KSS EASY TYPE FLEXIBLE CONDUIT ADAPTOR



PATENT

INSTALL INSTRUCTION



STEP1
Insert the conduit into the adaptor.

STEP2
Push lock out.

STEP3
Turn it around for locking.

PG THREAD

UNIT : mm

Item No.	PG Thread	Mounting Hole	Suitable Conduit	Packing
PAQ-0707	PG-7	12.5	PA-07	50 pcs (with screw nut)
PAQ-0709	PG-9	15.2	PA-07	
PAQ-1009	PG-9	15.2	PA-10	
PAQ-1209	PG-9	15.2	PA-12	
PAQ-1211	PG-11	18.6	PA-12	
PAQ-12135	PG-13.5	20.4	PA-12	
PAQ-1216	PG-16	22.5	PA-12	
PAQ-17135	PG-13.5	20.4	PA-17	
PAQ-1716	PG-16	22.5	PA-17	
PAQ-1721	PG-21	28.3	PA-17	
PAQ-2321	PG-21	28.3	PA-23	25 pcs (with screw nut)
PAQ-2929	PG-29	37.0	PA-29	10 pcs (with screw nut)
PAQ-3636	PG-36	47.0	PA-36	
PAQ-4848	PG-48	59.3	PA-48	

- Material: UL approved Nylon 66, 94V-2
- Color: Black
- Feature : One piece design, easy and faster installation without tool.

0620 KSS NYLON FLEXIBLE CONDUIT



- Material: UL approved Nylon 6 , 94HB
- Color: Black
- For running cable protection in Electrical /Machinery /Building Harness wiring.
- Flexible body facilitate your corner / elbow wiring.

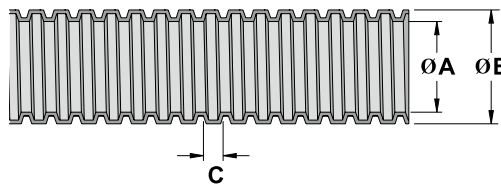

UNIT : mm

Item No.		Inch	Ø A	Ø B	C	Suitable Adaptor	Recommended Tools (see P.83)	Packing
Close design	Split design							
PA-07	PAO-07	1/4"	6.0 ± 0.25	9.8 ± 0.35	2.6 ± 0.3	PAQ-0707, PAQ-0709	KT-6BK	50 M
PA-10	PAO-10	5/16"	9.0 ± 0.25	13.0 ± 0.35	2.2 ± 0.3	PAQ-1009	KT-8BK	
PA-12	PAO-12	3/8"	11.4 ± 0.35	15.5 ± 0.35	2.3 ± 0.3	PAQ-1209, PAQ-1211, PAQ-12135, PAQ-1216	KT-8BK	
PA-17	PAO-17	1/2"	16.3 ± 0.35	21.6 ± 0.45	2.6 ± 0.4	PAQ-17135, PAQ-1716, PAQ-1721	KT-15BK	
PA-23	PAO-23	3/4"	22.4 ± 0.45	28.2 ± 0.45	2.4 ± 0.4	PAQ-2321	KT-20BK	
PA-29	PAO-29	1"	27.9 ± 0.45	34.0 ± 0.45	2.7 ± 0.4	PAQ-2929	KT-25BK	
PA-36	PAO-36	1 1/4"	35.8 ± 0.45	42.4 ± 0.6	2.3 ± 0.3	PAQ-3636	KT-32BK	25 M
PA-48	PAO-48	2"	47.5 ± 0.6	54.5 ± 0.6	2.3 ± 0.3	PAQ-4848	KT-32BK	

0620 KSS FLEXIBLE CONDUIT



- Material : PP
- Color: Black
- Function: For running cable protection in Electrical/Machinery/Building Harness wiring.
- For split design PP flexible conduit, can use the KSS Split Wrapping Band Installation tool (see P.83) to wrap the wire easily.
- ※ It may be harder while inserting split design conduit to claw.

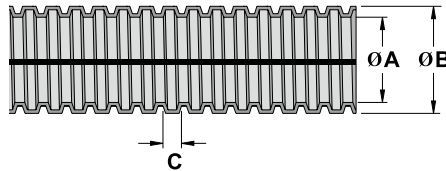

UNIT : mm

Item No.		Ø A	Ø B	C	Suitable Adaptor	Recommended Tools (see P.83)	Packing
Split design	Close design						
CR-05P	CRS-05P	5.6±0.4	7.9±0.4	2.6		KT-6BK	300 M
CR-07P	CRS-07P	7.4±0.4	10.2±0.4	2.6	PAQ-0707/PAQ-0709	KT-6BK	
CR-11SP	CRS-11SP	10.7±0.4	14.0±0.4	1.7		KT-8BK	200 M
CR-11P	CRS-11P	10.7±0.4	16.0±0.4	3.3	PAQ-1216 / PAQ-1211 / PAQ-1209 / PAQ-12135 / BG-16 / BGQ-16	KT-8BK	
CR-13P	CRS-13P	13.8±0.4	17.5±0.4	3.1	BG-18 / BGQ-18	KT-8BK / KT-15BK	
CR-15P	CRS-15P	15.0±0.4	19.5±0.4	3.5	BGQ-20	KT-15BK	100 M
CR-17P	CRS-17P	17.2±0.4	22.0±0.4	3.1	PAQ-17135 / PAQ-1721 / BG-22 / BGQ-22	KT-15BK	
CR-19P	CRS-19P	19.3±0.4	23.8±0.4	3.5	BG-26 / BGQ-25	KT-15BK / KT-20BK	
CR-22P	CRS-22P	21.2±0.4	25.8±0.4	3.1	BG-26 / BGQ-26	KT-15BK / KT-20BK	50 M
CR-24P	CRS-24P	24.3±0.4	32.0±0.4	3.61	BG-32 / BGQ-32	KT-20BK	
CR-25P	CRS-25P	25.0±0.4	30.0±0.4	4.1	BG-32	KT-20BK	
CR-28P	CRS-28P	28.0±0.4	34.0±0.4	3.1	BG-34 / BGQ-34	KT-25BK	50 M
CR-32P	CRS-32P	31.2±0.4	40.0±0.4	4.12	BG-40	KT-25BK / KT-32BK	
CR-35P	CRS-35P	34.9±0.4	42.0±0.4	3.1		KT-32BK	
CR-40P	CRS-40P	39.6±0.5	50.0±0.5	4.85	BG-48 / BG-50	KT-32BK	50 M
CR-48P	CRS-48P	47.5±0.5	54.5±0.5	2.0	PAQ-4848	KT-32BK	

0621 KSS CONVEY FLEXIBLE CONDUIT



- Close design

UNIT : mm

Item No.	Ø A	Ø B	C	Suitable Adaptor	Packing
CF-14P	10.7±0.4	14.1±0.4	2.04	BG-14	100 M
CF-18P	13.8±0.4	17.5±0.4	3.2	BG-18	
CF-22P	17.2±0.4	22.2±0.4	3.2	BG-22	
CF-26P	21.2±0.4	25.8±0.4	3.2	BG-26	50 M
CF-34P	28.7±0.4	34.0±0.4	3.2	BG-34	
CF-42P	34.9±0.4	42.0±0.4	3.2		

- Material: HDPE
- Color: Black
- Used to protect wiring inside the wall to replace normal PVC pipe. Flexible design for better wire running.

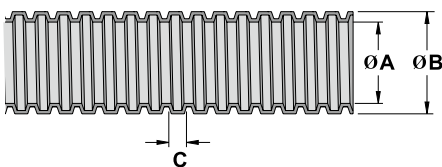

0621 KSS PVC FLEXIBLE CONDUIT



UNIT : mm

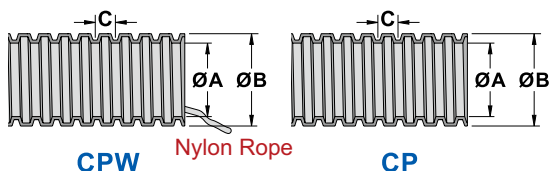

Item No.		Inch	Ø A	Ø B	C	Packing
Close Design With Nylon Rope	Close Design					
CPW-26POE	CP-26POE	1"	25.9	34.0	6.6	30.5M (100 FT)
CPW-34POE	CP-34POE	1 1/4"	34.1	42.6	6.6	
CPW-40POE	CP-40POE	1 1/2"	39.5	48.3	6.6	15.3M (50 FT)
CPW-51POE	CP-51POE	2"	50.8	60.5	6.6	

- Material: UL approved PVC, 94V-0
 - Color: Orange
 - Feature: 1. Compliant with RoHS.
2. Pre-inserted Nylon rope makes cable installation easier.
3. Great substitute for PVC pipe.
 - Application: Ideal use in indoor wirings such as optical fiber and telecommunication cable, vertical runs between floors, etc (except the plenum).
 - Usage: Cut the conduit into required length and fix cables on the pre-inserted Nylon rope in one side, then pull out the rope from the other side to finish the installation.
- ※ Split design and special colors are available on request

0617 KSS METAL FLEXIBLE CONDUIT ADAPTOR



UNIT : mm



Item No.	Mounting Hole	Conduit Suitable	Packing
MG-18	20.6	MCR04 3/8"	50 pcs
MG-22	20.6	MCR05 1/2"	
MG-26	25.0	MCR06 3/4"	
MG-32	32.6	MCR08 1"	25 pcs
MG-41	41.5	MCR10 1 1/4"	

- Material: ABS
- Color: Grey
- Conduit adaptor designed for metal conduit.

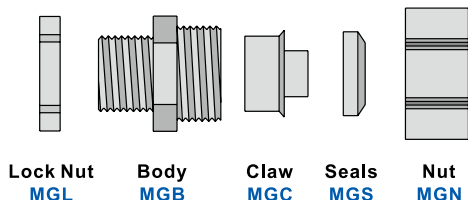

0625 KSS METAL FLEXIBLE CONDUIT



UNIT : mm

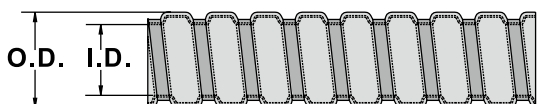

Item No.	Spec.	I.D.	O.D.	Packing
		mm		
MCR-02	1/4"	8.0	11.3	100 M
MCR-03	5/16"	10.0	13.6	
MCR-04	3/8"	12.6	16.2	50 M
MCR-05	1/2"	16.0	20.0	
MCR-06	3/4"	21.0	24.4	
MCR-08	1"	26.3	30.6	
MCR-10	1 1/4"	35.0	40.6	30 M
MCR-12	1 1/2"	40.3	46.0	25 M
MCR-16	2"	51.6	58.4	20 M
MCR-20	2 1/2"	64.5	71.6	10 M
MCR-24	3"	78.3	86.4	
MCR-32	4"	99.6	113.3	

- Material : metal with PVC tube.
- Waterproof, high tensile strength. Good resistance in bending, erosion.



0625 KSS METAL FLEXIBLE CONDUIT ADAPTOR



- Material: Zinc Alloy
- Feature: Waterproof, Corrosion resistance, Heat resistance.
- To Apply, putting NUT and SEAL on the end of metal flexible conduit, then screw CLAW of the metal adaptor into metal flexible conduit till tight.

Control box adaptor

UNIT : mm

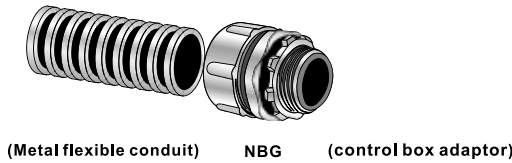

(Metal flexible conduit) NBG (control box adaptor)

Item No.	Thread specification		suitable for metal flexible conduit	Packing
	Pitch	mounting hole		
NBG-02	M16X1.5	15.5	MCR-02 (1/4")	50 pcs
NBG-03	M16X1.5	15.5	MCR-03 (5/16")	
NBG-04	PT1/2"	20.9	MCR-04 (3/8")	
NBG-05	PT1/2"	20.9	MCR-05 (1/2")	
NBG-06	PT3/4"	26.4	MCR-06 (3/4")	30 pcs
NBG-08	PT1"	33.2	MCR-08 (1")	
NBG-10	PT1 1/4"	41.9	MCR-10 (1 1/4")	20 pcs
NBG-12	PT1 1/2"	47.8	MCR-12 (1 1/2")	10 pcs
NBG-16	PT2"	59.6	MCR-16 (2")	5 pcs
NBG-20	PT2 1/2"	75.1	MCR-20 (2 1/2")	1 pcs
NBG-24	PT3"	87.8	MCR-24 (3")	
NBG-32	PT4"	113.0	MCR-32 (4")	



Inner thread type adaptor

UNIT : mm

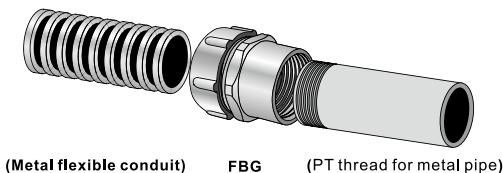

(Metal flexible conduit) FBG (PT thread for metal pipe)

Item No.	Thread specification		suitable for metal flexible conduit	Packing
	Pitch	mounting hole		
FBG-04	PS1/2"	18.8	MCR-04 (3/8")	50 pcs
FBG-05	PS1/2"	18.8	MCR-05 (1/2")	
FBG-06	PS3/4"	25.0	MCR-06 (3/4")	
FBG-08	PS1"	30.9	MCR-08 (1")	30 pcs
FBG-10	PS1 1/4"	39.9	MCR-10 (1 1/4")	20 pcs
FBG-12	PS1 1/2"	45.5	MCR-12 (1 1/2")	10 pcs
FBG-16	PS2"	57.2	MCR-16 (2")	5 pcs
FBG-20	PS2 1/2"	73.0	MCR-20 (2 1/2")	1 pcs
FBG-24	PS3"	85.9	MCR-24 (3")	
FBG-32	PS4"	110.9	MCR-32 (4")	



L type adaptor for control box

UNIT : mm

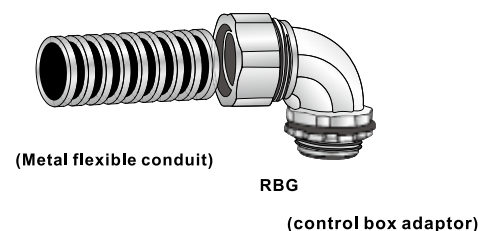

(Metal flexible conduit) RBG (control box adaptor)

Item No.	Thread specification		suitable for metal flexible conduit	Packing
	Pitch	mounting hole		
RBG-04	PT1/2"	20.9	MCR-04 (3/8")	50 pcs
RBG-05	PT1/2"	20.9	MCR-05 (1/2")	
RBG-06	PT3/4"	26.4	MCR-06 (3/4")	
RBG-08	PT1"	33.2	MCR-08 (1")	30 pcs
RBG-10	PT1 1/4"	41.9	MCR-10 (1 1/4")	20 pcs
RBG-12	PT1 1/2"	47.8	MCR-12 (1 1/2")	10 pcs
RBG-16	PT2"	59.6	MCR-16 (2")	5 pcs
RBG-20	PT2 1/2"	75.1	MCR-20 (2 1/2")	1 pcs
RBG-24	PT3"	87.8	MCR-24 (3")	
RBG-32	PT4"	113.0	MCR-32 (4")	

0625 KSS METAL FLEXIBLE CONDUIT ADAPTOR



- Material: Zinc Alloy
- Feature: Waterproof, Corrosion resistance, Heat resistance.
- To Apply, putting NUT and SEAL on the end of metal flexible conduit, then screw CLAW of the metal adaptor into metal flexible conduit till tight.

EMT pipe adaptor

UNIT : mm

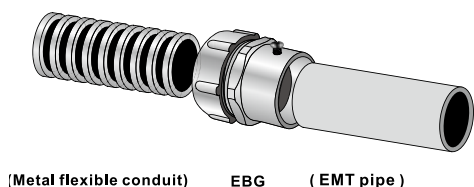

(Metal flexible conduit) EBG (EMT pipe)

Item No.	EMT Pipe	mounting hole	suitable for metal flexible conduit	Packing
EBG-04	E19(1/2")	19.5	MCR-04 (3/8")	50 pcs
EBG-05	E19(1/2")	19.5	MCR-05 (1/2")	
EBG-06	E25(3/4")	26.1	MCR-06 (3/4")	
EBG-08	E31(1")	32.2	MCR-08 (1")	30 pcs
EBG-10	E39(1 1/4")	38.7	MCR-10 (1 1/4")	20 pcs
EBG-12	E51(1 1/2")	51.7	MCR-12 (1 1/2")	10 pcs
EBG-16	E63(2")	63.9	MCR-16 (2")	5 pcs
EBG-20	E75(2 1/2")	76.8	MCR-20 (2 1/2")	1 pcs
EBG-24	E82(3")	89.5	MCR-24 (3")	
EBG-32	E104(4")	115.7	MCR-32 (4")	

PVC pipe adaptor

UNIT : mm

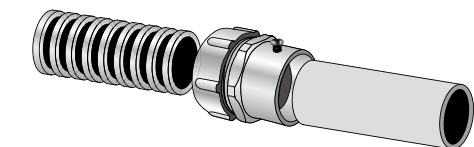

(Metal flexible conduit) PBG (PVC pipe)

Item No.	PVC Pipe	mounting hole	suitable for metal flexible conduit	Packing
PBG-05	#16(1/2")	22.3	MCR-05 (1/2")	50 pcs
PBG-06	#20(3/4")	27.7	MCR-06 (3/4")	
PBG-08	#28(1")	34.3	MCR-08 (1")	30 pcs
PBG-10	#35(1 1/4")	43.8	MCR-10 (1 1/4")	20 pcs
PBG-12	#41(1 1/2")	51.7	MCR-12 (1 1/2")	10 pcs
PBG-16	#52(2")	63.9	MCR-16 (2")	5 pcs
PBG-20	#65(2 1/2")	76.8	MCR-20 (2 1/2")	1 pcs
PBG-24	#80(3")	89.5	MCR-24 (3")	
PBG-32	#100(4")	115.7	MCR-32 (4")	

0625 KSS METAL FLEXIBLE CONDUIT END CAP



UNIT : mm



Item No.	suitable for metal flexible conduit	Packing
NBGC-02	MCR-02 (1/4")	50pcs
NBGC-03	MCR-03 (5/16")	
NBGC-04	MCR-04 (3/8")	
NBGC-05	MCR-05 (1/2")	
NBGC-06	MCR-06 (3/4")	
NBGC-08	MCR-08 (1")	
NBGC-10	MCR-10 (1 1/4")	20pcs
NBGC-12	MCR-12 (1 1/2")	10pcs
NBGC-16	MCR-16 (2")	5pcs
NBGC-20	MCR-20 (2 1/2")	1pcs
NBGC-24	MCR-24 (3")	
NBGC-32	MCR-32 (4")	

- Material: Zinc Alloy
- Function: Protect the end of metal flexible conduit.



BUSHINGS

0701 KSS MOVABLE BUSHING



UNIT : mm

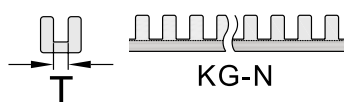
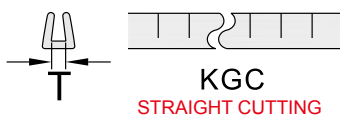
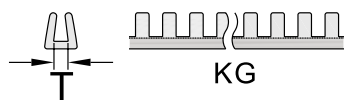
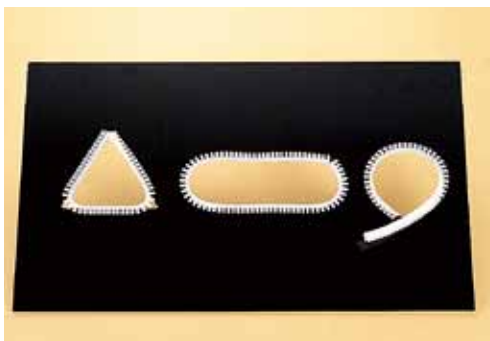

Item No.	T	Available Thickness	Packing
PE			
KG-008	0.8	under 0.8	10 M/bag
KG-010	1.0	0.8~1.0	
KG-012	1.2	1.0~1.2	
KG-016	1.6	1.2~1.6	
KG-020	2.0	1.6~2.0	
KG-024	2.4	2.0~2.4	
KG-032	3.2	2.4~3.2	
KGH-008	0.8	under 0.8	100M/RL
KGH-010	1.0	0.8~1.0	
KGH-012	1.2	1.0~1.2	
KGH-016	1.6	1.2~1.6	
KGH-020	2.0	1.6~2.0	
KGH-024	2.4	2.0~2.4	
KGH-032	3.2	2.4~3.2	
KGH-045	4.5	3.2~4.5	

STRAIGHT CUTTING

Item No.	T	Available Thickness	Packing	Material
KGC-012	1.2	1.0~1.2	10 M	PE
KGC-016	1.6	1.2~1.6		
KGC-020	2.0	1.6~2.0		
KGC-024	2.4	2.0~2.4		
KGC-032	3.2	2.4~3.2		
KGC-045	4.5	3.2~4.5		

Item No.	T	Available Thickness	Packing	Material
KG-010N	1.0	under 1.0	25 cm/pc 100 pcs/bag	NYLON
KG-014N	1.4	1.0~1.4		
KG-016N	1.6	1.2~1.6		
KG-020N	2.0	1.6~2.0		
KG-024N	2.4	2.0~2.4		
KG-032N	3.2	2.4~3.2		
KG-045N	4.5	3.2~4.5		

- Material: PE, NYLON (NATURAL color). Nylon product has more flexibility and better adhesion.
- Usage: Cut to fit any hole sizes for cords, wires, cables protection against damage from sharp panel edges.
- Function: Wires and cables protection and insulation.
- Advantage:
 1. Flexible, high adhesion, smooth surface.
 2. KGH series packed with paper spool for easy storage, and could be used for longer distance.

0703 KSS EDGING GROMMET



UNIT : mm

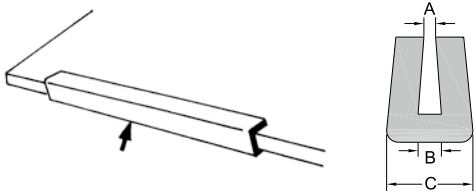

Item No.	A	B	C	Available Thickness	Packing
ED-010	0.5	1.0	3.3	under 1.0	10 M
ED-012	0.6	1.2	3.4	1.0~1.2	
ED-016	0.9	1.6	4.6	1.2~1.6	
ED-020	1.1	2.0	4.5	1.6~2.0	
ED-024	1.2	2.4	5.07	2.0~2.4	
ED-032	1.5	3.2	5.8	2.4~3.2	
ED-055	4.5	5.5	7.9	4.5~5.5	

- Material: PE Natural
- Cut length optionally to fit your chassis edging protection or other application for smoothing edges.
- Protect wires, cables and chassis insulation.

0705 KSS STRAIN RELIEF BUSHING



- Material: UL approved Nylon 66, 94V-2
- Color: Black
- Cuts assembly cost, prolongs cords life. Used extensively for protecting cords of computer, apparatus...etc.

CORD ASSEMBLY

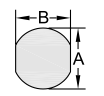
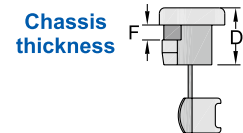
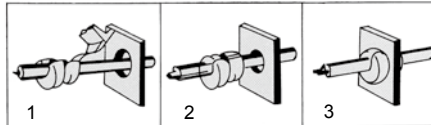

Mounting hole

UNIT : mm

Item No.	Cross Section Shape	Wires Accommodate		Mounting Hole		Part L. D	Available Thickness F	Packing
		UL Wire	Size	A	B			
SR-F21	Flat	SPT-1 #18	2.3X4.5 / 2.8X5.3	9.5	8.7	10.3	0.5-1.6	100 pcs
SR-F23		SPT-1 #18	2.3X4.5 / 2.8X5.3	9.5	8.7	10.3	1.8-3.2	
SR-F31		SPT-1 #18	3.0X5.6	11.2	9.9	10.3	1.0-1.6	
SR-F32		SPT-1 #18	3.0X5.6	11.0	9.9	10.3	1.9-2.5	
SR-F41		SPT-2 #18	3.0X7.1 / 3.8X7.6	12.7	11.8	10.3	0.5-1.6	
SR-F42		SPT-2 #18	3.0X7.1 / 3.8X7.6	12.7	11.8	10.3	1.8-2.5	
SR-F51		SPT-3 #18	5X10.4	14.3	12.9	15.2	0.5-1.6	
SR-F53		SPT-3 #18	5X10.4	14.3	12.9	15.2	1.8-3.5	
SR-F83			6X15.2	21.6	21.3	20.4	2.0-3.4	
SR-5R1	Round	SVI,SVT 3C #18	Ø6.2~Ø7.4	12.8	11.5	11.0	0.5-1.6	
SR-5R2		SVI,SVT 3C #18	Ø6.2~Ø7.4	13.0	11.5	11.0	1.8-2.5	
SR-6W2		SJT 3C #18	Ø7.6	12.8	11.8	11.0	1.8-2.3	
SR-6P1		SJT 3C #18	Ø7.4~Ø8.2	15.9	14.0	14.8	0.5-1.6	
SR-6P3		SJT 3C #18	Ø7.4~Ø8.2	15.9	14.0	14.8	1.9-3.2	
SR-6R1		SJ,SJT,3C #16	Ø8.2~Ø9.2	15.9	14.0	14.8	0.5-1.6	
SR-6R3		SJ,SJT,3C #16	Ø8.2~Ø9.2	15.9	14.0	14.8	1.9-3.2	
SR-7R1		SJT,3C #14	Ø9.2~Ø10.5 / Ø11	19.9	17.0	19.0	0.5-1.6	
SR-7R3		SJT,3C #14	Ø9.2~Ø10.5 / Ø11	19.7	17.0	19.0	1.9-3.2	
SR-8R3		SJT,3C #12	Ø12~Ø15.2	21.6	21.3	20.6	1.9-3.2	
SR-9R1	# 18 20-30pcs	Ø11~Ø15	15.0	19.0	17.5	0.5-1.6		
SR-9R7	SJT,3C # 10	Ø15.2~Ø16.3 / Ø17.5	28.0/30.2	25.5	25.2	1.0-3.2		

0705A KSS STRAIN RELIEF BUSHING ASSEMBLY TOOL



- Item No. : KT-1 (Stainless)
- Applicable: SR-F21 SR-F23 SR-F31 SR-F32
 Bushings SR-F41 SR-F42 SR-F51 SR-F53
 SR-5R1 SR-5R2 SR-6W2 SR-6P1
 SR-6P3 SR-6R1 SR-6R3 SR-7R1
 SR-7R3 SR-8R3 SR-9R7

0707 KSS SQUARE STRAIN RELIEF BUSHING



- Material: UL approved Nylon 66, 94V-2
- Cuts assembly cost, prolongs cords life. Used extensively for protecting cords of computer, apparatus...etc.

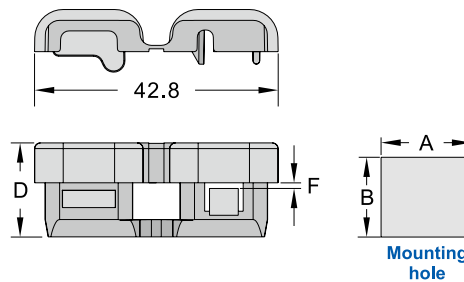

UNIT : mm

Item No.	Wires Accommodate		Mounting Hole		Part Length D	Available Thickness F	Packing
	UL Wire	Size	A	B			
SR-S41	SPT-1	3.0X5.6	16	11.5	16.5	1.0~1.2	100pcs
	SPT-2	3.8X7.6					

0708 KSS FLEXIBLE RIGHT ANGLE STRAIN RELIEF BUSHING



- Material: UL approved Nylon 66,94V-2
- Color: Black
- Protect power cable from computer, house appliance or electronic/ electrical equipment when power cable run out from bottom of equipment.
- Strain relief design protect power cord from breakage.
- Assemble according to photoes sequence above.

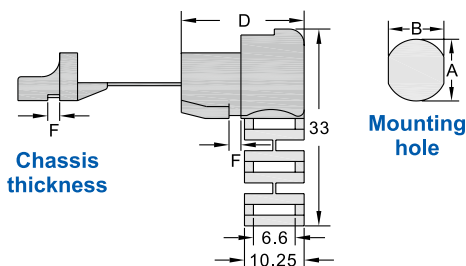

CORD ASSEMBLY

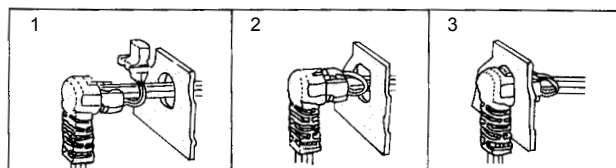

UNIT : mm

Item No.	Cross Section Shape	Wires Accommodate		Mounting Hole		Part Length D	Available Thickness F	Packing
		UL Wire	Size	A	B			
SR-F42LF	Flat	SPT-2	3.3 X 6.6	12.7 ~ 13.2	10.9	20.5	1.5~2.0	100 pcs
			3.6 X 7.2	13.2 ~ 13.7				



0708 KSS FLEXIBLE STRAIN RELIEF BUSHING



- Material: UL approved Nylon 66,94V-2
- Color: Black

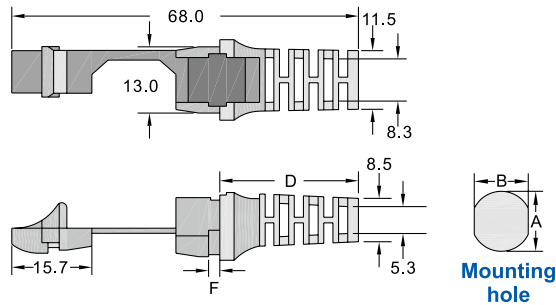

UNIT : mm

Item No.	Cross Section Shape	Wires Accommodate		Mounting Hole		Part Length D	Available Thickness F	Packing
		UL Wire	Size	A	B			
SR-F52F	Flat	SPT-2	4.6X8	14.3	13.2	36	0.8~2.3	100pcs

0709 KSS RIGHT ANGLE STRAIN RELIEF BUSHING



- Material: UL approved Nylon 66, 94V-2
- Color: Black
- Protect power cable from chassis.
- L type design facilitate power cord runs out.
- Assemble according photos as below.

CORD ASSEMBLY

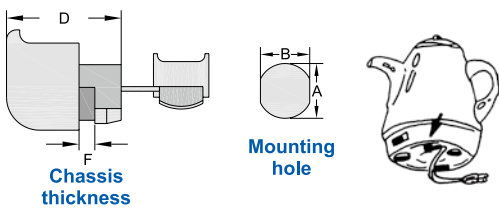
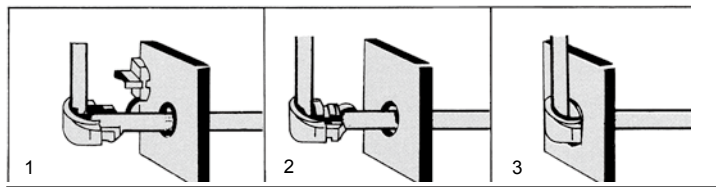

UNIT : mm

Item No.	Cross Section Shape	Wires Accommodate		Mounting Hole		Part Length D	Available Thickness F	Packing
		UL Wire	Size	A	B			
SR-F42L	Flat	SPT-1	3 X 5.6	12.7	11.8	17.7	1.8~2.6	100pcs
		SPT-2	3.8 X 7.1					

0710 KSS SNAP BUSHING



UNIT : mm

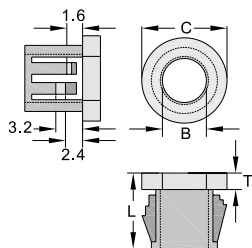

Standard design

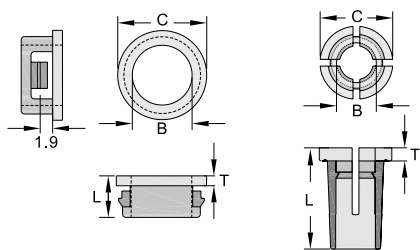

SB-7S,8S,12S,22S

SBP-8

Item No.	Mounting Hole		B	C	L	T	Packing
	mm	inch					
SB-7S	7.1	9/32"	5.8	8.8	6.1	1.3	100pcs
SB-8S	7.9	5/16"	6.8	9.8	6.0	1.5	
SB-12S	11.9	15/32"	9.2	13.7	6.3	1.5	
SB-22S	22.2	7/8"	19.6	24.0	6.5	1.5	
※ SB-8	7.9	5/16"	5.8	10.5	8.0	1.6	100pcs
※ SB-8A	7.9	5/16"	5.1	10.3	8.0	1.6	
SBP-8	7.4		5.9	10.8	15.0	2.0	
SB-10	9.5	3/8"	6.4	12.0	10.3	1.6	
SB-10M	9.5	3/8"	7.8	13.0	10.5	1.6	
SB-13	12.7	1/2"	8.0	15.0	10.3	1.6	
SB-14	14.3	9/16"	11.4	17.0	10.3	1.5	
SB-16	15.9	5/8"	12.7	18.6	10.3	1.6	
SB-19	19.1	3/4"	14.3	21.7	10.3	1.6	
SB-19M	19.1	3/4"	15.8	21.7	10.3	1.6	
SB-20	20.0		15.9	22.4	10.0	1.4	
SB-22	22.2	7/8"	17.5	24.2	11.5	1.6	
SB-22M	22.2	7/8"	18.9	24.2	11.5	1.6	
SB-25	25.4	1"	19.5	28.5	11.7	1.8	
SB-26	25.4		19.1	28.5	11.5	1.6	
SB-30	30.1	1 3/16"	24.1	33.3	11.5	1.6	
SB-32	32.0		23.8	34.6	11.4	1.5	
SB-38	38.1	1 1/2"	29.0	42.1	11.4	1.5	
SB-45	44.5	1 3/4"	35.4	47.8	11.6	1.5	
SB-50	50.8	2"	41.6	54.6	11.8	1.6	

- Material: UL approved Nylon 66 , 94V-2
- Color: Black
- KSS SNAP BUSHING smooth and insulate your raw-edged holes in metal chassis.
- Locking into hole firmly with fingertip pressure.
- Protect electrical cables, ropes, utility lines through metal holes.
- Available in application for chassis thickness under 3.2mm
- ※ SB-8A : available for chassis thickness under 2.2 mm
- ※ SB-8 : available for chassis thickness under 1.6 mm

0712 KSS SNAP BUSHING



UNIT : mm



Item No.	Mounting Hole		B	C	L	Packing
	mm	inch				
RSB-16	15.9	5/8"	12.7	20.5	10.3	100pcs
RSB-19	19.1	3/4"	14.8	24.0	10.0	
RSB-21	20.6	13/16"	15.2	24.3	10.0	
RSB-22	22.2	7/8"	17.0	25.4	11.5	
RSB-25	25.4	1"	20.4	28.5	11.5	
RSB-28	27.6	1 3/32"	23.0	31.2	11.5	
RSB-35	34.9	1 3/8"	29.5	38.5	11.7	
RSB-38	38.1	1 1/2"	31.0	41.0	11.0	

- Material: UL approved Nylon 66, 94V-2.
- Color: Black
- Universal design to hold various cable range with a fix size.

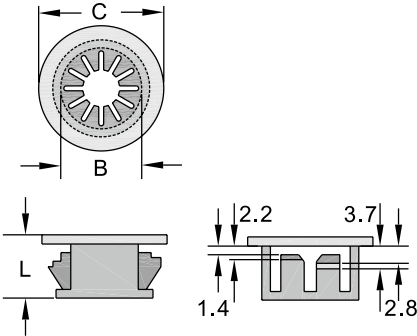

0713 KSS SNAP BUSHING [open/closed]



UNIT : mm



Item No.	Mounting Hole		B	C	L	Packing
	mm	inch				
OSB-9S	9.5	3/8"	6.5	11.3	6.1	100pcs
OSB-12S	12.7	1/2"	9.6	15.8	7.3	
OSB-10	9.5	3/8"	6.0	11.8	9.8	
OSB-13	12.7	1/2"	7.5	15.1	10.3	
OSB-16	15.9	5/8"	11.2	18.5	10.3	
OSB-19	19.1	3/4"	12.5	21.0	10.3	
OSB-22	22.2	7/8"	17.0	24.6	10.3	
OSB-26	25.4	1"	20.0	28.0	10.6	

- Material: UL approved Nylon 66,94V-2
- Color: Black
- Protect power cord and smooth chassis hole.
- Under 3.2mm chassis.
- Finger-tip pressure to install. No tool is needed.
- Can be applied after power cable installed.

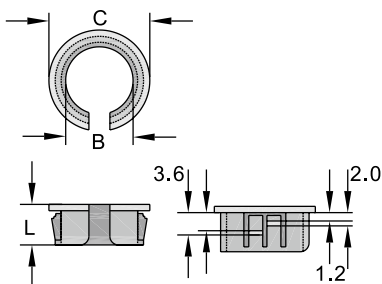

Standard design

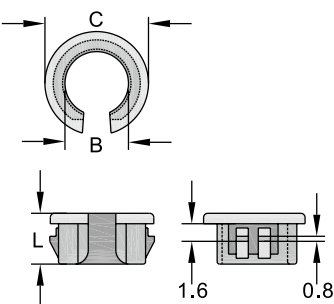

OSB-9S, 12S

0715 KSS HOLE PLUG



UNIT : mm

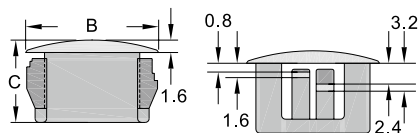

Item No.	Mounting Hole		B	C	Packing
	mm	inch			
HP-5	5.0		6.3	5.9	100pcs
HP-6	6.0		7.8	7.8	
HP-8	7.9	5/16"	10.3	8.1	
HP-10	9.5	3/8"	13.0	10.5	
HP-13S	12.7	1/2"	14.5	10.1	
HP-13	12.7	1/2"	16.5	10.9	
HP-15	14.3	9/16"	16.7	10.3	
HP-16	15.9	5/8"	19.5	10.0	
HP-19	19.1	3/4"	22.9	10.0	
HP-22	22.2	7/8"	25.8	11.3	
NEW HP-23	23.4		27.0	11.4	
HP-25	25.4	1"	29.0	11.6	
HP-30	30.1	1 3/16"	34.5	12.0	
NEW HP-35	34.9	1 3/8"	38.1	14.3	
HP-38	38.1	1 1/2"	42.1	11.2	
HP-45	44.5	1 3/4"	49.7	11.8	

- Material: UL approved Nylon 66, 94V-2
- Color: Black
- Available in application for chassis thickness under 3.2mm
- KSS HOLE PLUG close your unneeded holes with fingertip pressure at low cost and assure good appearance.

0716 KSS SCREW PLUG



UNIT : mm

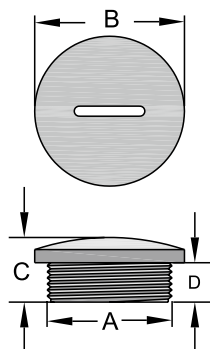

METRIC THREAD

Item No.	External thread	A	B	C	D	Packing
MSP-12	M12x1.5	11.7	15.0	10.0	6.0	100 pcs
MSP-16	M16x1.5	15.7	20.0	10.5	6.0	
MSP-20	M20x1.5	19.9	24.0	10.5	6.0	
MSP-25	M25x1.5	24.7	29.7	12.8	7.8	
MSP-32	M32x1.5	31.7	36.6	13.3	7.8	50 pcs
MSP-40	M40x1.5	39.9	45.8	13.4	7.8	
MSP-50	M50x1.5	49.4	55.5	16.2	9.8	10 pcs
MSP-63	M63x1.5	62.4	69.3	17.5	11.8	

- Material : UL approved Nylon66, 94V-2
- Color : Black (Grey available)
- KSS SCREW PLUG close your unneeded holes at low cost and assure good appearance.



0717 KSS SCREW PLUG

UNIT : mm

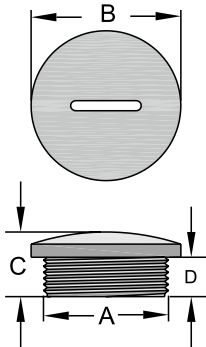

PG THREAD

Item No.	External thread	A	B	C	D	Packing
PSP-7	PG-7	12.2	14.8	10.0	6.0	100 pcs
PSP-9	PG-9	15.1	18.7	10.4	6.0	
PSP-11	PG-11	18.5	21.7	10.4	6.0	
PSP-13.5	PG-13.5	20.3	23.7	10.3	6.0	
PSP-16	PG-16	22.3	27.0	10.3	6.0	
PSP-21	PG-21	28.2	32.8	12.8	7.8	50 pcs
PSP-29	PG-29	37.0	44.1	13.3	7.8	
PSP-36	PG-36	47.0	52.6	13.7	7.7	10 pcs
PSP-42	PG-42	54.0	59.5	16.3	9.6	
PSP-48	PG-48	59.6	64.2	18.0	11.8	

- Material : UL approved Nylon66, 94V-2
- Color : Black (Grey available)
- KSS SCREW PLUG close your unneeded holes at low cost and assure good appearance.

0721 KSS EASY FIT GROMMET [open/closed]



UNIT : mm



Item No.		A	B	C	D	E	F	Packing
Open	Close							
GE-2015	GEC-2015	23.9	19.6	15.5	2.1	2.0	3.9	100 pcs
GEQ-2015	GECQ-2015	23.9	19.6	15.5	2.1	2.0	3.9	
GEQ-2621	GECQ-2621	30.0	26.0	20.8	2.4	2.4	3.8	

- Material : PVC
- Color: Black

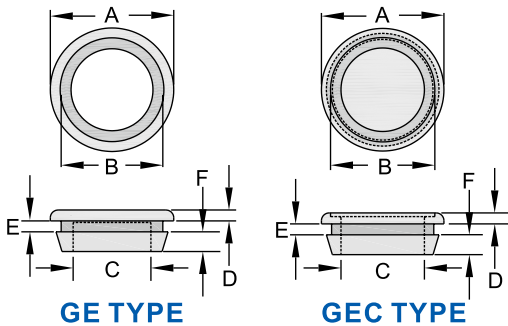

0720 KSS GROMMET (open/closed)



UNIT : mm

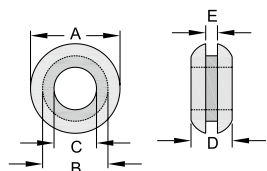

GM TYPE

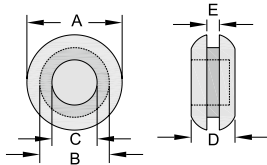

GMC TYPE

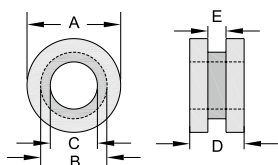

GM-1108

Item No.		A	B	C	D	E	Packing
Open	Close						
GM-0603	GMC-0603	8.5	6.0	3.0	4.7	1.7	100 pcs
GM-0705	GMC-0705	10.2	7.2	5.0	4.7	1.7	
GM-1006	GMC-1006	13.3	10.0	6.4	6.5	1.7	
GM-1108S	GMC-1108S	15.5	10.9	7.8	7.8	2.3	
GM-1108	GMC-1108	15.5	11.0	7.8	9.0	3.0	
GM-1410	GMC-1410	19.5	13.9	10.5	6.4	3.4	
GM-2015	GMC-2015	23.7	20.1	15.5	6.1	1.7	
GM-2518	GMC-2518	29.9	25.1	18.9	7.2	1.5	
GM-3225	GMC-3225	38.1	31.7	25.0	7.8	1.5	

GMQ-0603	GMCQ-0603	8.5	6.0	3.0	4.7	1.7	100 pcs
GMQ-0705	GMCQ-0705	10.2	7.2	5.0	4.7	1.7	
GMQ-1006	GMCQ-1006	13.3	10.0	6.4	6.5	1.7	
GMQ-1108S	GMCQ-1108S	15.5	10.9	7.8	7.8	2.3	
GMQ-1108	GMCQ-1108	15.5	11.0	7.8	9.0	3.0	
GMQ-1410	GMCQ-1410	19.5	13.9	10.5	6.4	3.4	
GMQ-2015	GMCQ-2015	23.7	20.1	15.5	6.1	1.7	
GMQ-2518	GMCQ-2518	29.9	25.1	18.9	7.2	1.5	
GMQ-3225	GMCQ-3225	38.1	31.7	25.0	7.8	1.5	

● Material : PVC

● Color: Black

※ Available with soft type upon requested, please add "Q" to item no. as GMQ-0603 / GMCQ-0603

0723 KSS SQUARE HEAD GROMMET NUT



UNIT : mm

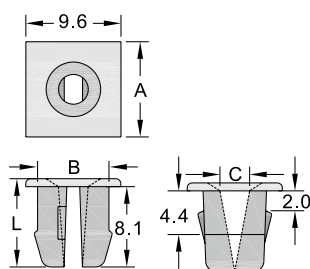

Item No.	A	B	C	L	Packing
SGN-07	9.6	7.2	3.0	8.9	100pcs

● Material :UL approved Nylon 66, 94V-2

● Color : Natural

0725 KSS D TYPE HOUSING COVER



UNIT : mm

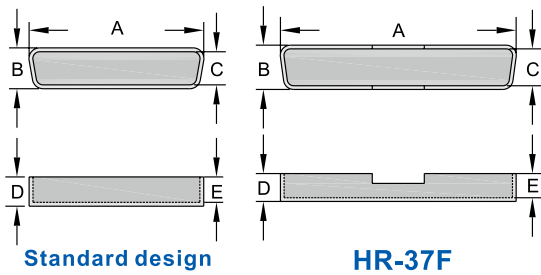

Item No.	A	B	C	D	E	Packing	Suitable Socket
HR-9M	20.0	11.0	9.2	7.2	6.1	100 pcs	9 pin male
HR-9F	18.1	9.2	7.85	6.5	5.7		9 pin female
HR-15M	28.2	10.9	9.1	7.0	6.0		15 pin male
HR-15F	26.5	9.5	7.5	6.9	5.9		15 pin female
HR-25M	42.0	10.9	9.1	7.3	6.3		25 pin male
HR-25F	40.6	9.5	7.8	6.8	5.9		25 pin female
HR-37F	57.5	10.9	8.3	7.5	6.5		37 pin female

- Material : PE
- Color : Natural
- To protect pin connector from dirty.

0727 KSS ROUND HOUSING COVER



UNIT : mm



Item No.		A	B	C	D	Packing
PE	NYLON 66					
RHR-6PE	RHR-6	8.2	8.8	7.3	6.1	100pcs
RHR-7PE	RHR-7	8.0	3.0	2.5	6.6	
RHR-8PE	RHR-8	10.4	8.0	6.9	8.3	

- Material : PE or NYLON 66.
- Color : Natural
- To protect pin connector from dirty.

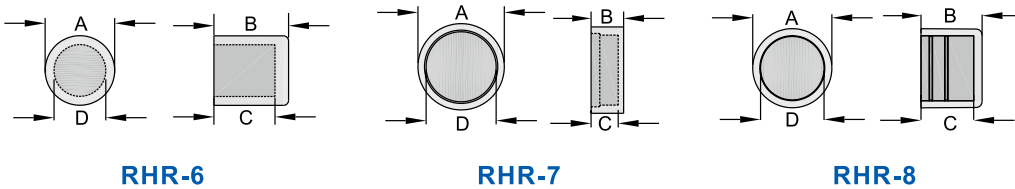

0730 KSS USB HOUSING COVER



UNIT : mm



Item No.	Dimension	Packing
USB-1	USB Type A	100pcs
USB-3	USB Type C	

NEW

- Material : PE
- Color : Natural
- To protect pin connector from dirty.

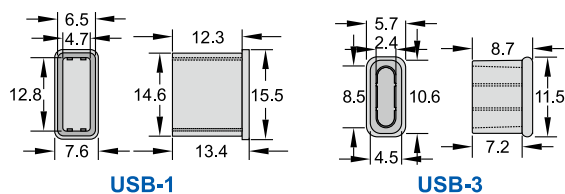

0730 KSS USB HOUSING COVER



UNIT : mm



Item No.	Dimension	Packing
USB-2	As Figure	100pcs

- Material: PE
- Color : Black
- Function: Dust cover for USB plug.

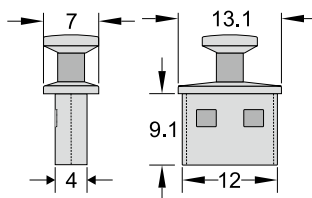

0731 KSS FUSE COVER



UNIT : mm



Item No.	Dimension	Packing
FR-1	As Figure	100pcs

- Material : Transparent PVC
- To protect fuse from dirty.

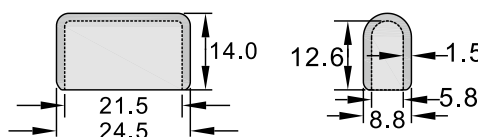

0733 KSS PLUG COVER



UNIT : mm



Item No.	Dimension	Design	Packing
PR-2	As Figure	Standard	100pcs
PR-3		Ground	

- Material: PE
- Color : Black
- To protect plug from dirty

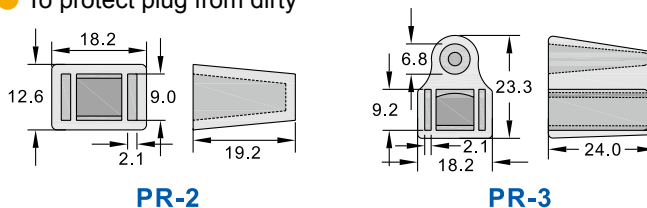

0735 KSS SCREW PLUG



UNIT : mm



Item No.	Dimension	Packing
HPA-16	As Figure	100pcs

- Material : PP
- Color : Natural
- For automotive hydraulic pump plugs into the hole.

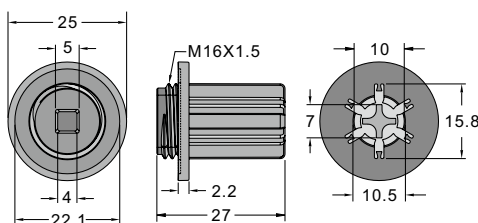



WIRE CONNECTORS

0801 KSS CLOSE-END WIRE CONNECTOR



- Material : UL approved Nylon 66, flammability rating 94V-2 / 94V-0, copper.
- Tested by the glow-wire flammability index (GWFI), at a glow wire temperature of 800°C for 94V-2 grade and 960°C for 94V-0 grade.
- Insert pre-stripped wires then use crimping tool to hold wires firmly.

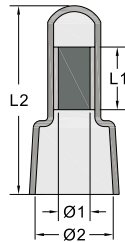

UNIT : mm

Item No.		L1	L2	Ø1	Ø2	Suitable Wires			Packing							
94V-2	94V-0					mm ²	AWG	DIN mm ² d								
CE-1	CE-1V0	7.0	20.0	2.4	7.8	1.25	22-16	0.5-1.75	100pcs							
CE-2	CE-2V0	7.0	20.0	3.0	8.0	2.0	16-14	1.0-3.0								
CE-5	CE-5V0	8.0	25.3	3.8	10.5	5.5	12-10	2.5-6.0								
CE-8	CE-8V0	8.5	27.8	4.7	12.0	8.0	8	4.0-9.0								
AWG	2	4	6	8	10	12	14	16	18	20	22	24	26	28	30	32
mm ²	33.4	20.8	13.2	8.4	5.3	3.3	2.1	1.3	0.83	0.52	0.33	0.21	0.13	0.08	0.05	0.03

0804 KSS WIRE NUT DRIVE



UNIT : mm



Item No.	Packing
SWT-1	1 pc

- Material : Nylon 66
- Color : Black
- Socket tool used with electrical screwdriver, make fast and easy installation for screw on wire connector.

0808 KSS SCREW ON WIRE CONNECTOR



UNIT : mm

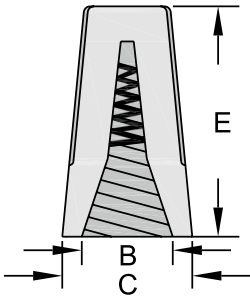

Item No.	B	C	E	Wire Combination		Color	Packing
				sq	AWG		
SW-71BH	6.5	8.6	15.2	Max. 2#1.25 Min. 2#0.5	Max. 2#16 Min. 2#18	Grey	100 pcs
SW-72BH	7.1	9.9	17.7	Max. 3#1.25 Min. 2#0.5	Max. 3#16 Min. 2#18	Blue	
SW-73BH	9.7	12.7	22.0	Max. 2#2.0 Min. 3#1.25	Max. 4#14 Min. 3#16	Orange	
SW-74BH	11.0	14.0	24.6	Max. 3#3.5 Min. 2#2.0	Max. 3#12 Min. 3#14	Yellow	
SW-76BH	13.1	16.3	26.5	Max. 2#5.5 Min. 2#3.5	Max. 5#10 Min. 2#12	Red	

- Material: Tough thermoplastic, UL 94V-2 flame-retardant shell.
- Strip wires before application.
- Rated at 600 volt max. for building wiring.
- Temp. 105°C (221°F)
- Spring design provided more secure connection.

0809 KSS SCREW ON WIRE CONNECTOR



UNIT : mm

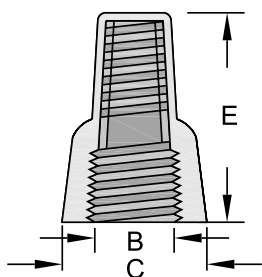

Item No.	B	C	E	Wire Combination		Color	Packing
				sq	AWG		
SW-Y11H	9.8	18.2	25.8	Max. 3#3.5 Min. 2#0.5	Max. 3#12 Min. 2#18	Yellow	100 pcs
SW-Y12H	13.0	23.0	31.8	Max. 5#3.5 Min. 3#1.25	Max. 5#12 Min. 3#16	Red	
SW-Y13H	14.9	25.5	33.3	Max. 3#5.5 Min. 3#3.5	Max. 3#10 Min. 3#12	Grey	
SW-Y14H	17.8	31.8	40.0	Max. 3#8 Min. 2#5.5	Max. 2#8 Min. 2#10	Blue	

- Material: Tough thermoplastic, UL 94V-2 flame-retardant shell.
- Two wing makes move easy twist on termination of wires.
- Strip wires before application.
- Rated at 600 volt max. for building wiring.
- Temp. 105°C (221°F)
- Spring design provided more secure connection.

0810 KSS MID-WAY WIRE CONNECTOR



UNIT : mm

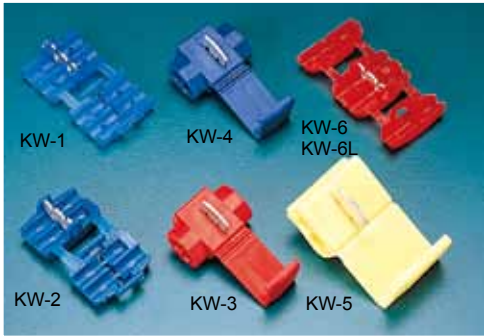

Item No.		Wire Combination	Connection	Color	Packing
PP	NYLON 66				
KW-1	KW-1N	18AWG-14AWG		Blue	100 pcs
KW-2	KW-2N	18AWG-14AWG		Blue	
KW-3	KW-3N	22AWG-18AWG		Red	
KW-4	KW-4N	18AWG-14AWG		Blue	
KW-5	KW-5N	12AWG-10AWG		Yellow	
KW-6	KW-6N	22AWG-20AWG		Red	
KW-6L	KW-6LN	18AWG-14AWG		Red	
	KW-10N	22AWG-18AWG		Red	
	KW-11N	16AWG-14AWG		Blue	
	KW-12N	12AWG-10AWG		Yellow	

- Material: PP or Nylon 66 .
- Insert wires on the grooves of connector, clamps down the plastic body and electricity can be conducted.
- Quick installation without stripping wire.
- Can be joined for connection



TUBES

0901 KSS VINYL WIRE END CAP



UNIT : mm

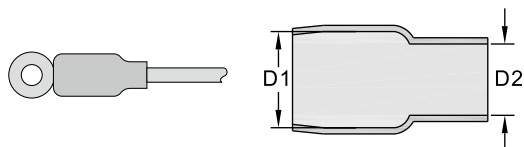

Item No.	sq	Dimension		Color	Packing
		D1	D2		
V-1.25	1.25	3.3	3.1	Red、Blue、 White、Black、 Yellow、Green Brown、Grey	100 pcs
V-2	2	4.5	3.7		
V-3.5	3.5	5.1	4.0		
V-5.5	5.5	5.7	4.9		
V-8	8	6.8	6.2		
V-14	14	8.8	8.0		
V-22	22	11.6	9.8		
V-38	38	14.5	13.0		
V-60	60	16.4	14.0		
V-80	80	18.2	15.8		
V-100	100	21.6	18.2		
V-125	125	23.6	20.3		
V-150	150	25.3	22.3		
V-200	200	31.4	24.4		
V-250	250	32.8	27.0		
V-325	325	35.3	29.5		
V-400	400	45.1	37.3		
V-500	500	48.0	40.2		
V-630	630	53.8	44.6		
					50 pcs
					25 pcs

- Material: Soft PVC
- Suitable for all kinds of switchboard and complicated machinery to tell different colors. Soft and flexible material can be used for different shapes of end terminals, easy to tighten and take off.
- Feature 1: Smooth and bright surface
- Feature 2: Stable thickness
- Feature 3: Consistant length
- Feature 4: Even opening ends
- Feature 5: Tidy the wiring works
- Standard color: Red, white, blue, yellow, black, Green. (brown grey available upon request)

0906 KSS VINYL TUBE



UNIT : mm



- Material: Soft PVC

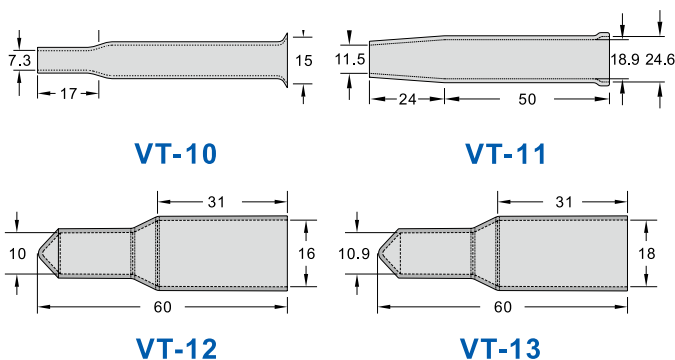

0905 KSS VINYL WIRE END MARKER CAP



UNIT : mm



Item No.	sq	mm	Color	Packing
MV-1.25	1.25	3.2	Red · Blue · White · Black · Yellow · Green	100 pcs
MV-2	2.0	3.6		
MV-3.5	3.5	4.2		
MV-5.5	5.5	5.1		

- Welcome for special request.

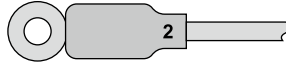

0907 KSS END CAP



UNIT : mm

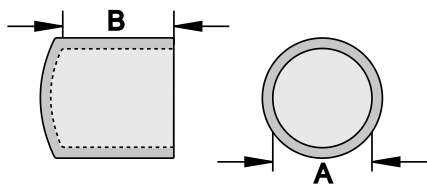

EP TYPE

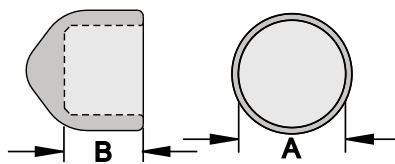

EPA-0505

Item No.	ØA sq	B	Color	Packing
EP-0308S	3.0	8.8	THINNER WALL	100 pcs
EP-0308	3.0	8.0	Black (Red · Blue · White · Black · Yellow · Green Upon Request)	
EP-0312	3.2	12.0		
EP-0408	4.0	8.0		
EP-0412	4.8	12.0		
EP-0416	4.8	16.0		
EP-0418S	4.0	18.0		
EP-0418	4.8	18.0		
NEW EPA-0505	5.7	5.0		
EP-0510	5.7	10.0		
EP-0513	5.7	13.5		
EP-0612	6.3	12.0		
EP-0708	7.6	8.0		
EP-0804	8.0	4.0		
EP-0809	7.8	9.5		
EP-0824	8.0	24.0		
EP-0905	9.4	5.0		
EP-0912	9.4	12.0		
EP-1113	11.4	13.0		
EP-1216	12.0	16.0		
EP-1420	14.0	20.0		
EP-1435	14.0	35.0		
EP-1713	17.8	13.0		

- Material: Soft PVC
- Color : Black

0908 KSS HEXAGONAL PROTECTION CAP



UNIT : mm



Item No.	Nut	Dimension	Packing
HPM-8	M8	As Figure	100 pcs

- Material: PE
- Color : Black

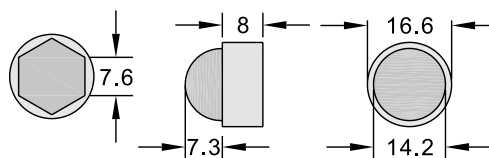

0908 KSS SCREW PROTECTION CAP



UNIT : mm



Item No.	Dimension				Packing
	D	D1	H	H1	
SCP-0709	13	7.5	10.2	9.3	100 pcs

- Material: PE
- Color : Black

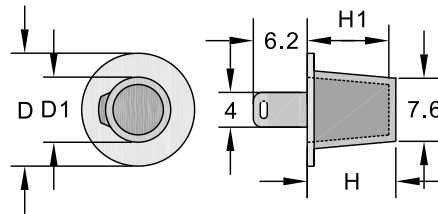

0909 KSS SCREW PROTECTION CAP



UNIT : mm



Item No.	Suitable Screw	W	W1	W2	H	H1	Packing
SCA-1948	3/4"	39.2	26.3	19.0	52.0	48.0	40pcs
SCA-2656	1 "	50.4	37.6	25.2	62.5	56.2	
SCA-3270	1 1/4"	62.0	48.0	30.9	77.4	70.4	20pcs

- Material: Soft PVC
- Feature: Easy to install without using any tool.
- Color: Grey

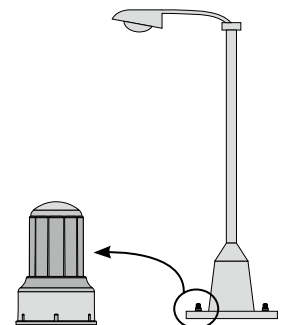
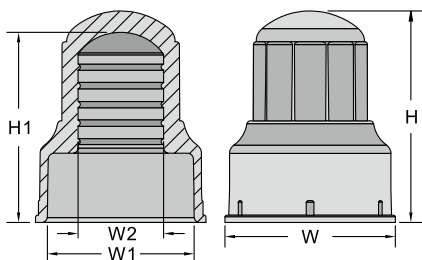



0910 KSS ALLIGATOR CLIP

UNIT : mm



Item No.	L	ØC	Ampere	Color	Remarks	Packing
AC-1	35	3.0	2A	Red 、 Black (Blue 、 Green 、 White 、 Yellow Upon Request)	Clip c/w Tube	100 pcs
AC-2	42	3.0	3A			
AC-3	50	3.4	5A			
AC-4	68	4.0	10A			
AC-5	80	5.0	20A			

● Material: Soft PVC for tube, iron with nickel plated for clip.

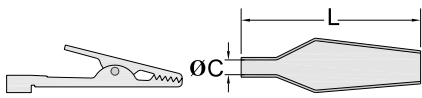

AC-1,AC-2,AC-3

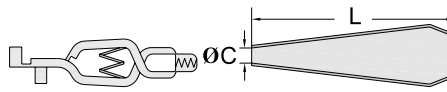

AC-4,AC-5



0915 KSS TUBE OF ALLIGATOR CLIP

UNIT : mm



Item No.	Dimension				Color	Remarks	Packing
	L	ØA	ØB	ØC			
BC-1	35	5	9	3.0	Red 、 Black (Blue 、 Green 、 White 、 Yellow Upon Request)	Tube	100 pcs
BC-2	42	6	10	3.0			
BC-3	50	9	13	3.4			
BC-4	68	15	16	4.0			
BC-5	80	15	21	5.0			

● Material: Soft PVC

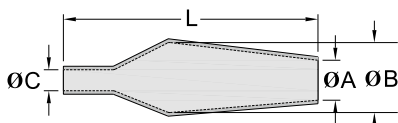

BC-1,BC-2,BC-3

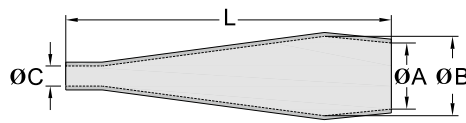

BC-4,BC-5

0920 KSS HEAT-SHRINKABLE SLEEVE



UNIT : mm

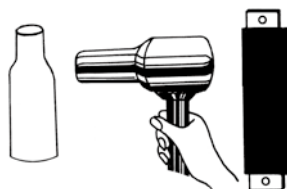
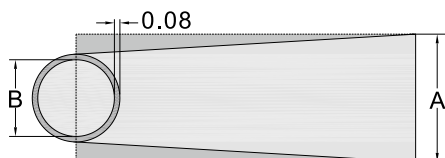

Item No.	Cay flat Dia Ø A	Ø B	SHRINKABLE RANGE	Color	Packing
HS-6.5	6.5	4.1	6.5~3.6	Red、 White、 Blue、 Black (Yellow、 Green Upon Request)	100 M Per Roll
HS-8.5	8.5	5.2	8.5~4.5		
HS-12	12	7.6	12~6.5		
HS-15	15	10	15~8.5		
HS-20	20	13	20~11		
HS-30	30	19	30~16		
HS-40	40	25	40~22		
HS-50	50	32	50~28		
HS-60	60	38	60~33		
HS-70	70	44	70~37		
HS-80	80	50	80~42		
HS-100	100	63	100~55		
HS-120	120	76	120~65		
HS-150	150	95	150~90		
HS-170	170	108	170~94		
HS-200	200	127	200~110		

- Material: Rigid Shrinkable PVC.
- Shrink temperature: min. 100°C
- Radial Shrinking: 45~50%; Longitudinal Shrinking: 8~15%
- Continuous operating temperature: -15 to 105°C.
- Thickness : 0.08mm
- Used for color distinction and insulation of busbar in controll panel. To be shrinked by blower or hot water.

0927 KSS HEAT-SHRINKABLE TUBINGS



UNIT : mm



Item No.	As supplied		After Shrinkage		Packing (Spool)	
	125°C UL CSA	Inside Diameter min.	Wall Thickness nominal	Inside Diameter max.		Wall Thickness nominal
K34-1		1.4 ± 0.2	0.10	0.50	0.20	200 M / Roll
K34-1.5		2.0 ± 0.2	0.10	0.75	0.20	
K34-2		2.3 ± 0.2	0.10	1.00	0.20	
K34-2.5		2.9 ± 0.2	0.15	1.25	0.25	
K34-3		3.3 ± 0.3	0.15	1.50	0.25	
K34-3.5		3.8 ± 0.3	0.15	1.75	0.25	100 M / Roll
K34-4		4.4 ± 0.3	0.15	2.00	0.25	
K34-5		5.5 ± 0.3	0.15	2.50	0.25	
K34-6		6.5 ± 0.4	0.15	3.00	0.28	50 M / Roll
K34-7		7.5 ± 0.4	0.15	3.50	0.28	
K34-8		8.5 ± 0.4	0.15	4.00	0.28	
K34-9		9.5 ± 0.4	0.15	4.50	0.28	
K34-10		10.5 ± 0.5	0.15	5.00	0.28	

- Material: polyolefin.
- Standard color: Black, other colors available on request.
- Shrink temperature: min. 90°C
- Shrink ratio: 2:1; Radial change: min. 50%; Longitudinal change: -5 ± 5%
- Continuous operating temperature: -55 to 125°C
- UL/CSA Recognized, flammability VW-1, UL rating voltage 300V
- Application: Insulation & protection for cable and connector.

0927 KSS HEAT-SHRINKABLE TUBINGS



※ SUMITOMO Authorized Distributor

UNIT : mm



NEW

Item No.	Size inch	As supplied		After Shrinkage		Packing (Spool)
		Inside Diameter min.	Wall Thickness nominal	Inside Diameter max.	Wall Thickness	
K2-3/64	3/64	1.2	0.10	0.6	0.25 ± 0.05	305M / Roll
K2-1/16	1/16	1.6	0.10	0.8	0.25 ± 0.05	
K2-3/32	3/32	2.4	0.12	1.2	0.27 ± 0.04	152.5M / Roll
K2-1/8	1/8	3.2	0.12	1.6	0.27 ± 0.04	
K2-3/16	3/16	4.8	0.12	2.4	0.27 ± 0.04	
K2-1/4	1/4	6.4	0.14	3.2	0.33 ± 0.05	61M / Roll
K2-3/8	3/8	9.5	0.14	4.8	0.33 ± 0.05	
K2-1/2	1/2	12.7	0.14	6.4	0.33 ± 0.05	
K2-3/4	3/4	19.1	0.18	9.5	0.43 ± 0.07	
K2-1	1	25.4	0.20	12.7	0.48 ± 0.07	

- Material: semi-rigid flame-retarded PVDF.
- Color: colors available on request.
- Shrink temperature: min. 150°C
- Shrink ratio: 2:1; Radial change: min. 50%; Longitudinal change: min. -10 to 5%
- Continuous operating temperature: -55 to 175°C
- SAE-AMS/UL recognized, flammabilityVW-1
- Application: Protection for wire and devices which are used in motorcycle or under high temperature or exposed to chemicals and oils.

0927 KSS HEAT-SHRINKABLE TUBINGS WITH INNER GLUE



※ SUMITOMO Authorized Distributor

UNIT : mm



NEW

Item No.	As supplied		After Shrinkage			Length
	Inside Diameter min.	Wall Thickness nominal	Inside Diameter max.	Wall Thickness nominal	Adhesive Thickness nominal	
SSA3-1	5.8	0.45	1.26	1.20	0.56	1.22M
SSA3-2	7.5	0.60	1.64	1.52	0.76	
SSA3-3	10.9	0.70	2.40	1.91	1.02	
SSA3-4	17.8	0.80	4.45	2.41	1.37	

- Material: polyolefin with glue.
- Color: black.
- Shrink temperature: min. 135°C
- Shrink ratio: 4:1; Radial change: min. 75%; Longitudinal change: min. -10%
- Continuous operating temperature: -40 to 130°C
- Application: High shrink ratio(4:1) and waterproof protection for harness joints of motor vehicles.

0927 KSS HEAT-SHRINKABLE TUBINGS WITH INNER GLUE



※ SUMITOMO Authorized Distributor

UNIT : mm

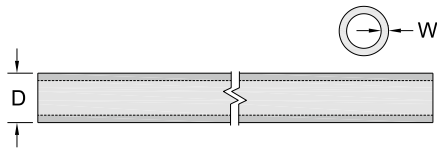

Item No.	As supplied		After Shrinkage		Length
	Inside Diameter min.	Inside Diameter max.	Wall Thickness nominal		
			Outer Layer	Inner Layer	
SCM-04	10.2	3.8	1.5	0.75	1.22M
SCM-07	19.0	5.6	2.0	0.75	
SCM-11	28.0	9.5	2.0	0.90	
SCM-13	33.0	10.2	2.3	1.20	
SCM-15	38.1	12.7	2.3	1.20	
SCM-17	44.0	14.0	2.3	1.20	
SCM-20	52.0	18.2	2.3	1.20	
SCM-27	70.0	25.5	2.3	1.20	
SCM-35	90.0	30.0	2.5	1.20	
SCM-50	125.0	40.0	2.5	1.20	

- Material: polyolefin with glue.
- Color: black.
- Shrink temperature: min. 100°C
- Shrink ratio: 3:1; Radial change: min. 60%; Longitudinal change: min. -10%
- Continuous operating temperature: -55 to 120°C
- Application: Waterproof protection for outdoor cable and connector.

0927 KSS HEAT-SHRINKABLE TUBINGS WITH INNER GLUE



※ SUMITOMO Authorized Distributor

UNIT : mm



Item No.	Size (inch)	As supplied		After Shrinkage			Length
		Inside Diameter min.	Wall Thickness nominal	Inside Diameter max.	Wall Thickness nominal	Adhesive Thickness nominal	
W3F2-1/8	1/8	3.2	0.35	0.6	0.95	0.35	1.22M
W3F2-3/16	3/16	4.8	0.45	1.5	1.1	0.60	
W3F2-1/4	1/4	6.4	0.45	2.0	1.2	0.65	
W3F2-3/8	3/8	9.5	0.50	3.0	1.3	0.65	
W3F2-1/2	1/2	12.7	0.55	4.0	1.4	0.75	
W3F2-3/4	3/4	19.1	0.65	8.0	1.6	0.80	
W3F2-1	1	25.4	0.75	10.2	1.9	0.80	

- Material: polyolefin with glue.
- Color: black.
- Shrink temperature: min. 110°C
- Shrink ratio: 3:1; Radial change: min. 60%; Longitudinal change: min. -15%
- Continuous operating temperature: -55 to 125°C
- UL/CSA Recognized, rating voltage 600V
- Application: Waterproof, anticorrosion, insulation and protection on different cable connecting.
- ※ The thickness of wall includes glue.

0927 KSS HEAT-SHRINKABLE TUBINGS



- Material: polyolefin.
- Standard color: Black, other colors available on request.
- Shrink temperature: min. 90°C
- Shrink ratio: 2:1; Radial change: min. 50%; Longitudinal change: $-5 \pm 5\%$ (min. -15% for FZ)
- Continuous operating temperature: -55 to 125°C (-55 to 105°C for FZ)
- K32 is UL/CSA Recognized, FZ is UL Recognized, both have flammability VW-1, rating voltage 600V
- Application: Insulation & protection for cable and connector.

UNIT : mm

Item No.	As supplied (mm)		After shrinkage (mm)		Packing (Spool)
	125°C UL CSA Inside Diameter min.	Wall Thickness nominal	Inside Diameter max.	Wall Thickness nominal	
K32-1	1.4 ± 0.2	0.20	0.5	0.33	200 M / Roll
K32-1.5	2.0 ± 0.2	0.20	0.75	0.36	
K32-2	2.5 ± 0.2	0.20	1.0	0.44	
K32-2.5	3.0 ± 0.2	0.25	1.25	0.44	
K32-3	3.5 ± 0.3	0.25	1.5	0.44	
K32-3.5	4.0 ± 0.3	0.25	1.75	0.44	
K32-4	4.5 ± 0.3	0.25	2.0	0.44	
K32-5	5.4 ± 0.3	0.25	2.5	0.56	100 M / Roll
K32-6	6.4 ± 0.4	0.25	3.0	0.56	
K32-7	7.4 ± 0.4	0.25	3.5	0.56	50 M / Roll
K32-8	8.4 ± 0.4	0.25	4.0	0.56	
K32-9	9.4 ± 0.4	0.25	4.5	0.56	
K32-10	10.4 ± 0.4	0.25	5.0	0.56	
K32-11	11.4 ± 0.4	0.25	5.5	0.56	
K32-12	12.4 ± 0.4	0.25	6.0	0.56	
K32-13	13.5 ± 0.4	0.30	6.5	0.69	
K32-14	14.5 ± 0.4	0.30	7.0	0.69	
K32-15	15.5 ± 0.5	0.30	7.5	0.69	
K32-16	16.8 ± 0.5	0.30	8.0	0.69	
K32-18	18.7 ± 0.5	0.35	9.0	0.77	
K32-20	21.2 ± 0.6	0.35	10.0	0.77	
K32-22	23.2 ± 0.6	0.40	11.0	0.77	
K32-25	26.1 ± 0.8	0.40	12.5	0.87	
K32-28	29.0 ± 1.0	0.50	14.0	0.87	
K32-30	32.0 ± 1.0	0.50	15.0	0.87	
105°C UL					
FZ-35	37 ± 1.0	0.50	17.5	0.87	30 M / Roll
FZ-40	43.0 ± 1.5	0.50	20.5	0.97	
FZ-50	53.0 ± 2.0	0.50	25.0	0.97	
FZ-60	60min.	0.55	30.0	1.07	
FZ-80	80min.	0.60	40.0	1.17	
FZ-100	100min	0.60	50.0	1.17	

0927 KSS HALOGEN FREE HEAT-SHRINKABLE TUBINGS



※ SUMITOMO Authorized Distributor

UNIT : mm



- Material: non-halogen flexible polyolefin.
- Standard color: Black.
- Shrink temperature: min. 100°C
- Shrink ratio: 2:1; Radial change: min. 50%; Longitudinal change: -5 ± 5%
- Continuous operating temperature: -55 to 125°C
- UL Recognized, flammability VW-1, rating voltage 600V
- Application: Insulation & protection for cable and connector.

Item No.	As supplied		After Shrinkage		Packing (Spool)
	125°C UL CSA	Inside Diameter min.	Wall Thickness nominal	Inside Diameter max.	
NHR2-1	1.4 ± 0.2	0.20	0.50	0.33	200M / Roll
NHR2-1.5	2.0 ± 0.2	0.20	0.75	0.36	
NHR2-2	2.5 ± 0.2	0.20	1.00	0.44	
NHR2-2.5	3.0 ± 0.2	0.25	1.25	0.44	
NHR2-3	3.5 ± 0.3	0.25	1.50	0.44	
NHR2-3.5	4.0 ± 0.3	0.25	1.75	0.44	
NHR2-4	4.5 ± 0.3	0.25	2.00	0.44	100M / Roll
NHR2-5	5.4 ± 0.3	0.25	2.50	0.56	
NHR2-6	6.4 ± 0.4	0.25	3.00	0.56	
NHR2-7	7.4 ± 0.4	0.25	3.50	0.56	
NHR2-8	8.4 ± 0.4	0.25	4.00	0.56	
NHR2-9	9.4 ± 0.4	0.25	4.50	0.56	
NHR2-10	10.4 ± 0.4	0.25	5.00	0.56	50M / Roll
NHR2-11	11.4 ± 0.4	0.25	5.50	0.56	
NHR2-12	12.4 ± 0.4	0.25	6.00	0.56	
NHR2-13	13.5 ± 0.4	0.30	6.50	0.69	
NHR2-14	14.5 ± 0.4	0.30	7.00	0.69	
NHR2-15	15.5 ± 0.5	0.30	7.50	0.69	
NHR2-16	16.8 ± 0.5	0.30	8.00	0.69	
NHR2-18	18.7 ± 0.5	0.35	9.00	0.77	
NHR2-20	21.2 ± 0.6	0.35	10.00	0.77	
NHR2-22	23.2 ± 0.6	0.40	11.00	0.77	
NHR2-25	26.1 ± 0.8	0.40	12.50	0.87	
NHR2-28	29.0 ± 1.0	0.50	14.00	0.87	
NHR2-30	32.0 ± 1.0	0.50	15.00	0.87	

0927 KSS HALOGEN FREE HEAT-SHRINKABLE TUBINGS



※ SUMITOMO Authorized Distributor

UNIT : mm



- Material: non-halogen flexible polyolefin.
- Standard color: Black.
- Shrink temperature: min. 100°C
- Shrink ratio: 2:1; Radial change: min. 50%; Longitudinal change: -5 ± 5%
- Continuous operating temperature: -55 to 125°C
- UL Recognized, flammability VW-1, rating voltage 300V
- Application: Insulation & protection for cable and connector.

Item No.	As supplied		After Shrinkage		Packing (Spool)	
	125°C UL CSA	Inside Diameter min.	Wall Thickness nominal	Inside Diameter max.		Wall Thickness nominal
NHR4-1	1.4 ± 0.2	0.10	0.50	0.20	200M / Roll	
NHR4-1.5	1.9 ± 0.2		0.75	0.20		
NHR4-2	2.3 ± 0.2		1.00	0.20		
NHR4-2.5	2.9 ± 0.2	0.15	1.25	0.25		100M / Roll
NHR4-3	3.3 ± 0.3		1.50	0.25		
NHR4-3.5	3.8 ± 0.3		1.75	0.25		
NHR4-4	4.4 ± 0.3		2.00	0.25		
NHR4-5	5.5 ± 0.4		2.50	0.25	50M / Roll	
NHR4-6	6.5 ± 0.4		3.00	0.28		
NHR4-7	7.5 ± 0.4		3.50	0.28		
NHR4-8	8.5 ± 0.4		4.00	0.28		
NHR4-9	9.5 ± 0.4	4.50	0.28			
NHR4-10	10.5 ± 0.5	5.00	0.28			

0931 KSS PVC TUBE



- Material: Flexible, flame retardant PVC.
- Feature: PVC tube is flame retardant, flexible and high reliability products.
- Standard Colors: Black, other colors are available upon request (Clear, White, Red, Blue, Yellow, Green, Brown, Grey, Orange, Violet).

Standard Size

UNIT : mm

300V		600V		Inside Diameter	Suitable Wire	Packing	
Item No.	Wall Thickness	Item No.	Wall Thickness				
NHS-065	0.30 ± 0.06	NHS-065V6	0.47 ± 0.08	0.65 ± 0.10	22AWG	500 M / Roll	
NHS-080	0.37 ± 0.06	NHS-080V6	0.47 ± 0.08	0.80 ± 0.10	20AWG		
NHS-090	0.37 ± 0.06	NHS-090V6	0.47 ± 0.08	0.90 ± 0.10	19AWG		
NHS-100	0.37 ± 0.06	NHS-100V6	0.47 ± 0.08	1.00 ± 0.15	18AWG		
NHS-120	0.37 ± 0.06	NHS-120V6	0.60 ± 0.08	1.20 ± 0.15	17AWG		
NHS-130	0.37 ± 0.06	NHS-130V6	0.60 ± 0.08	1.30 ± 0.15	16AWG		
NHS-150	0.37 ± 0.06	NHS-150V6	0.60 ± 0.08	1.50 ± 0.15	15AWG		
NHS-170	0.37 ± 0.06	NHS-170V6	0.60 ± 0.08	1.70 ± 0.15	14AWG		
NHS-190	0.40 ± 0.06	NHS-190V6	0.60 ± 0.08	1.90 ± 0.20	13AWG		
NHS-210	0.40 ± 0.06	NHS-210V6	0.60 ± 0.08	2.10 ± 0.20	12AWG		
NHS-240	0.40 ± 0.06	NHS-240V6	0.60 ± 0.08	2.40 ± 0.20	11AWG	300 M / Roll	
NHS-270	0.40 ± 0.06	NHS-270V6	0.60 ± 0.08	2.70 ± 0.20	10AWG		
NHS-300	0.47 ± 0.08	NHS-300V6	0.60 ± 0.08	3.00 ± 0.25	9AWG		
NHS-330	0.47 ± 0.08	NHS-330V6	0.60 ± 0.08	3.30 ± 0.25	8AWG		
NHS-370	0.47 ± 0.08	NHS-370V6	0.60 ± 0.08	3.70 ± 0.25	7AWG		
NHS-420	0.47 ± 0.08	NHS-420V6	0.60 ± 0.08	4.20 ± 0.30	6AWG		
NHS-470	0.47 ± 0.08	NHS-470V6	0.60 ± 0.08	4.70 ± 0.30	5AWG		
NHS-530	0.47 ± 0.08	NHS-530V6	0.60 ± 0.08	5.30 ± 0.30	4AWG		
NHS-590	0.47 ± 0.08	NHS-590V6	0.60 ± 0.08	5.90 ± 0.30	3AWG		200 M / Roll
NHS-660	0.47 ± 0.08	NHS-660V6	0.60 ± 0.08	6.60 ± 0.30	2AWG		
NHS-740	0.47 ± 0.08	NHS-740V6	0.60 ± 0.08	7.40 ± 0.35	1AWG	150 M / Roll	
NHS-830	0.47 ± 0.08	NHS-830V6	0.60 ± 0.08	8.30 ± 0.35	0AWG		

Inch Size

300V		600V		Inside Diameter		Packing
Item No.	Wall Thickness	Item No.	Wall Thickness	inch	mm	
NHS-800	0.47 ± 0.08	NHS-800V6	0.60 ± 0.08	5/16"	8.0 ± 0.35	150 M / Roll
NHS-950	0.60 ± 0.08	NHS-950V6		3/8"	9.5 ± 0.35	200 M / Roll
NHS-111		NHS-111V6		7/16"	11.1 ± 0.35	
NHS-127		NHS-127V6		1/2"	12.7 ± 0.35	150 M / Roll

0933 KSS HOT MELT ADHESIVE GLUE



UNIT : mm



Item No.	Inside Diameter D	Wall Thickness t	Length L
HM-0.55	0.55	0.24	1M
HM-1.1	1.10	0.35	
HM-1.5	1.50	0.40	
HM-3.5	3.50	0.40	

- Material: PE Copolymer.
- To connect optical fiber and prevent corrosions.

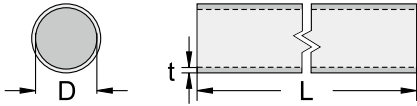

0933 KSS OVAL HOT MELT ADHESIVE TUBE



UNIT : mm



Item No.	D	d	Wall Thickness t	No. of Fibers	Length L
HM-3014	3.80	2.20	0.40	4	1M
HM-3216	3.90	2.25	0.35	8	
NEW HM-3819	4.55	2.65	0.40	12	

- Material: PE Copolymer.
- To connect optical fiber and prevent corrosions.

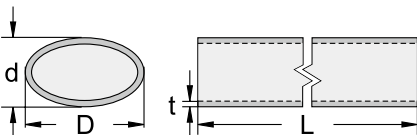



CABLE CLIPS

1001 KSS NAIL CABLE CLIP



UNIT : mm



Item No.	W	H	H1	Suitable Wires	Nails	Packing
NT-1	4.8	7.0	2.5	0.2m/m ² 2C&4C	2X15	100 pcs

- Material: PE
- Color: Grey
- With nail inserted, Steel nail for Masonry.
- Applied for telephone cords.

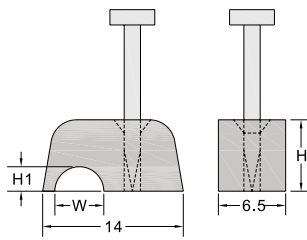

1001 KSS NAIL CABLE CLIP



UNIT : mm



Item No.	W	Nails	Packing
NT-0204	4.1	2X20	100 pcs
NT-0407	7.0	2X20	
NT-0711	9.0	2X35	
NT-1114	13.2	2X35	

- Material: PE
- Color: White (others available upon request)
- With nail inserted, Steel nail for Masonry.

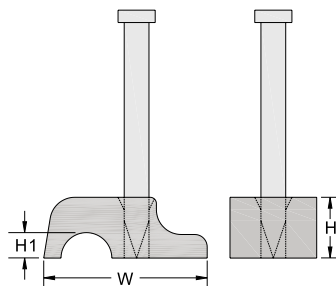

1005 KSS NAIL CABLE CLIP



UNIT : mm



Item No.	W	H1	H	Suitable Wires	Nails	Packing
NF-0.18	4.5	2.7	4.3	0.8mm/m ² c	2.0X15	100 pcs
NFR-1	5.1	3.0	6.8	0.8mm/m ² c	2.5X18	

- Material: PE
- Color: White (others available upon request)
- With nail inserted, Steel nail for Masonry.
- Applied for telephone cords.

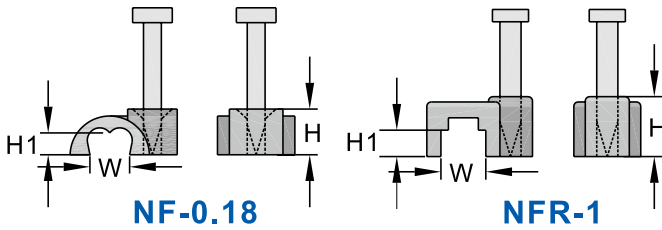

1010 KSS NAIL CABLE CLIP



UNIT : mm

◆ Thin Nail

Item No.	W	H1	H	Suitable Wires	Nails	Packing
NF-2.0S	8.5	5.2	8.0	1.5mm ² Flat T&E	2.0X25	100 pcs
NF-2.2S	10.0	6.5	10.0	2.5mm ² Flat T&E	2.0X25	

◆ Standard Nail

NF-0.25	2.1	1.2	4.5		1.65X15	100 pcs
NF-0.7	5.5	3.1	5.5		2.0X15	
NF-1.2	6.2	3.8	6.4		2.0X15	
NF-1.4	6.4	4.1	7.0		2.0X25	
NF-1.6	8.0	5.0	8.0	1.0mm ² Flat T&E	2.0X15	
NF-2.0	8.5	5.2	8.0	1.5mm ² Flat T&E	2.5X18	
NF-2.2	10.0	6.5	10.0	2.5mm ² Flat T&E	2.5X18	
NF-2.3	10.2	4.6	8.0		2.0X25	
NF-2.6	13.5	8.1	11.6	6.0mm ² Flat T&E	2.5X22	
NF-2.8	15.0	8.7	12.8		2.5X22	
NF-3.0	18.0	9.5	12.9	10mm ² Flat T&E	2.5X27	
NF-3.2	19.0	11.1	14.2	16mm ² Flat T&E	2.5X27	
NF-5.0	49.0	26.0	33.0		4.0X50	50 pcs
NFT-4.0	11.6	6.4	9.7	4.0mm ² T&E	2.0X25	100 pcs
NF-1122	21.1	11.3	14.5		2.5X35	

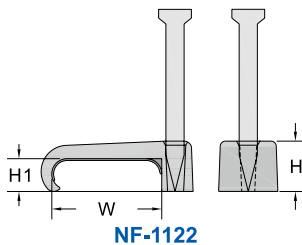
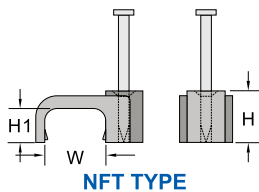
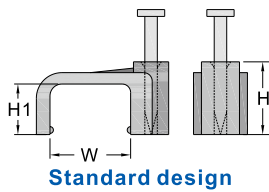

- Material: PE
- With nail inserted, Steel nail for Masonry.
- Color: White (others available upon request)

1011 KSS NAIL CABLE CLIP



UNIT : mm



Item No.	W	H1	H	Suitable Wires	Nails	Color	Packing
NJ-9.5NA	9.5	4.5	9.0	1.5mm ² Flat T&E	2.0X25	Natural	100 pcs
NJ-12NA	12.4	6.0	10.4	2.5mm ² Flat T&E	2.0X25		
Item No.	W	H1	H	Suitable Wires	Nails	Color	Packing
NFP-2.1	9.3	4.0	8.7	2.5mm ² Twin	2.0X25	White	100 pcs
NF-2.6S	11.9	6.2	9.6	4.0mm ² Twin	2.0X25		
NF-2.8S	15.0	6.8	11.0	6.0mm ² Twin	2.0X25		

- Material: PE
- With nail inserted, Steel nail for Masonry.
- Applied for telephone cords.

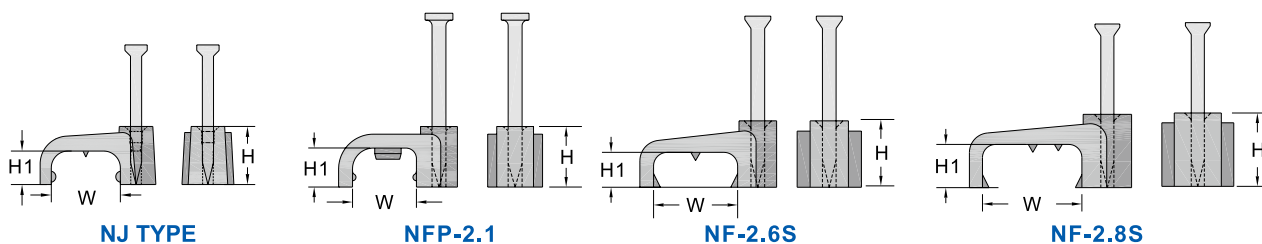

1010 KSS NAIL CABLE CLIP



UNIT : mm



Item No.	W	H1	H	Suitable Wires	Nails	Packing
NFTT-1.0GYT	7.6	4.0	6.8	1.0mm ² Flat T&E	2.0X25	100 pcs
NFTT-1.5GYT	8.5	4.5	7.3	1.5mm ² Flat T&E	2.0X25	
NFTT-2.5GYT	10.3	5.3	8.2	2.5mm ² Flat T&E	2.0X25	
NFTT-4.0GYT	11.9	6.4	9.5	4.0mm ² Flat T&E	2.0X25	
NFTT-6.0GYT	13.3	7.3	10.5	6.0mm ² Flat T&E	2.0X30	
NFT-10GYT	17.1	8.7	11.6	10mm ² Flat T&E	2.0X30	
NFT-16GYT	20.2	10.0	13.2	16mm ² Flat T&E	2.5X35	
NFT-1.5GYT	9.8	4.4	6.7	1.0mm ² +1.5mm ² Flat 3C+E	2.0X25	
NFD-1.0GYT	17.0	4.5	7.2	1.0mm ² +1.5mm ² DOUBLE Flat T&E	2.0X25	
NFD-2.5GYT	19.0	5.3	8.6	2.5mm ² DOUBLE Flat T&E	2.0X25	

- Material: PE
- With nail inserted, Steel nail for Masonry.
- Color: Grey (others available upon request)
- Applied for telephone cords.

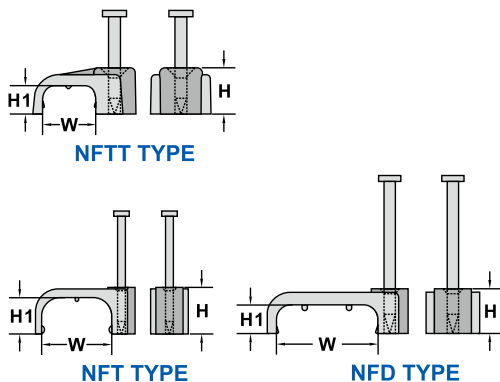

1011 KSS NAIL CABLE CLIP



UNIT : mm

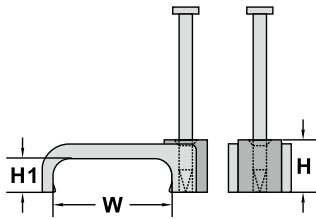
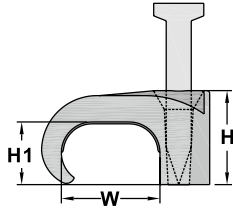

Item No.	W	H1	H	Suitable Wires	Nails	Color	Packing
NF-0204NA	4.0	2.0	4.0	For Bellwire	1.2X15	Natural	100 pcs
NF-0305NA	4.6	3.3	5.2	Speaker cable	1.2X20		
NF-0406NA	5.8	3.8	5.9	For Sheath Twin Cable	1.4X20		
NF-0508GY	7.9	4.9	7.5	For 1.0 & 1.5mm ² T&E	2.0X25	Grey	
NF-0610GY	9.8	5.8	8.2	For 2.5mm ² T&E	2.0X25		
NF-0714GY	11.8	6.5	9.3	For 4 & 6mm ² T&E	2.5X25		
NF-0918GY	16.7	9.4	12.2	For 10 & 16mm ² T&E	2.5X30		
NFD-0508GY	15.1	4.5	7.0	For 2x1.0 & 1.5mm ² T&E	2.5X25		
NFD-0610GY	19.2	5.3	8.4	For 2x2.5mm ² T&E	2.5X25		

NFD TYPE

- Material: PE
- With nail inserted, Steel nail for Masonry.
- Applied for telephone cords.

1020 KSS NAIL CABLE CLIP

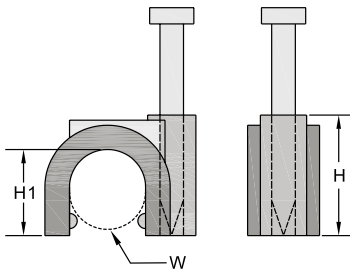

◆ **Thin Nail**

UNIT : mm

Item No.	W	H1	H	Nails	Packing
NC-0.5NS	5.0	5.0	7.6	2.0X20	100 pcs
NC-1NS	6.0	6.6	9.0	2.0X20	
NC-2NS	8.0	8.15	12.9	2.0X25	
NC-2.5NS	9.0	9.0	12.0	2.0X25	
NC-3NS	10.0	10.4	12.8	2.0X25	

◆ **Standard Nail**

NC-0.275N	2.75	2.6	4.5	1.65X19	100 pcs
NC-0.35N	3.5	3.7	5.9	2.0X15	
NC-0.4N	4.0	4.2	6.6	2.5X18	
NC-0.5N	5.0	5.0	7.6	2.5X18	
NC-0.5NBK (Black)	5.0	5.0	7.6	2.5X18	
NC-1N	6.0	6.6	9.6	2.5X18	
NC-1NBK (Black)	6.0	6.6	9.6	2.5X18	
NC-1NL	6.0	6.9	10.5	2.5X20	
NC-1.5N	7.0	7.5	11.0	2.5X22	
NC-1.5NBK (Black)	7.0	7.5	11.0	2.5X22	
NC-2N	8.0	8.2	12.9	2.5X22	
NC-2.5N	9.0	9.0	12.8	2.5X22	
NC-3N	10.0	10.4	13.8	2.5X25	
NC-3.5N	11.0	12.2	16.6	2.5X27	
NC-4N	12.0	12.3	16.0	2.5X27	
NC-6N	14.0	15.6	20.0	3.0X35	
NC-7N	16.0	17.0	21.7	3.2X38	
NC-7.2N	18.0	17.5	22.4	3.2X38	
NC-7.3N	19.0	18.6	23.3	3.2X38	
NC-7.5N	20.0	18.5	23.5	3.2X38	
NC-8N	22.0	23.0	27.8	3.2X42	
NC-9SN	23.0	24.1	29.0	3.2X47	
NC-9N	25.0	25.0	30.4	3.2X47	
NC-10N	32.0	33.5	40.0	3.6X56	50 pcs
NEW NC-10.2N	34.0	34.0	40.0	3.6X56	

- Material: PE
- With nail inserted, Steel nail for Masonry.
- Color: White / Grey / Black (others available upon request)
- Applied for telephone cords.



1019 KSS NAIL CABLE CLIP

UNIT : mm



Item No.	W	H1	H	Suitable Wires	Nails	Color	Packing
NU-0203NA	2.8	2.8	4.3	For 2-3mm Round Cable	1.2X15	Natural	100 pcs
NU-0305NA	2.9	3.7	5.6	For 3-5mm Round Cable	1.2X20		
NU-0507	5.3	6.0	8.0	For 5-7mm Round Cable	2.0X25		
NU-0710	6.8	7.1	9.5	For 7-10mm Round Cable	1.6X25	White	
NU-1014	9.4	10.3	13.0	For 10-14mm Round Cable	2.0X30		
NU-1420	13.1	13.7	17.1	For 14-20mm Round Cable	2.0X35		
NU-1822	16.4	17.0	19.5	For 18-22mm Round Cable	2.5X45		
NU-2226	19.5	21.0	24.0	For 22-26mm Round Cable	2.5X45		

- Material: PE
- With nail inserted, Steel nail for Masonry.
- Applied for telephone cords.

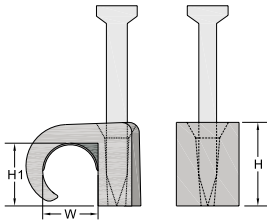

1018 KSS NAIL CABLE CLIP



UNIT : mm



Item No.	W	H1	H	Suitable Wires	Nails	Packing
NS-0508	5.0	7.0	8.3	For 5-8mm Round Cable	1.2X20	100pcs
NS-0812	8.0	9.0	11.0	For 8-12mm Round Cable	2.0X30	
NS-1014	10.0	10.0	12.0	For 10-14mm Round Cable	2.0X30	
NS-1420	14.0	14.0	16.5	For 14-20mm Round Cable	2.0X35	
NS-2026	18.0	20.0	23.0	For 20-26mm Round Cable	2.5X45	

- Material: PE
- With nail inserted, Steel nail for Masonry.
- Color: White (others available upon request)

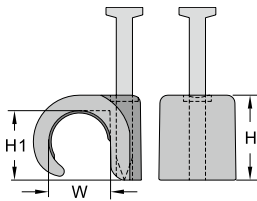

1020 KSS NAIL CABLE CLIP



UNIT : mm



Item No.	W	H1	H	Suitable Wires	Nails	Packing
NEW NC-0507S	5.7	5.2	7.1	For 5-7mm Round Cable	1.65 x 19	100 pcs
NC-0507	5.7	5.2	7.1	For 5-7mm Round Cable	2.0 x 20	
※ NC-0507L	6.1	6.0	8.5	For 5-7mm Round Cable	2.0 x 20	
NC-0810	7.8	8.0	10.9	For 8-10mm Round Cable	2.0 x 25	
NC-1115	11.2	11.0	14.7	For 11-15mm Round Cable	2.0 x 35	
NC-1619	14.4	14.6	18.4	For 16-19mm Round Cable	2.5 x 40	

- Material: PE
- With nail inserted, Steel nail for Masonry.
- Color: White (others available upon request)
- ※ NC-0507L Longer hook

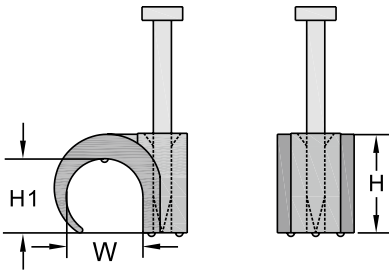

1020 KSS NAIL CABLE CLIP



UNIT : mm



Item No.	W	H1	H	Nails	Packing
NU-7N	16.0	17.7	21.5	3.2X38	100 pcs
NU-8N	20.0	21.7	26.4	3.2X42	
NU-9N	24.0	25.8	31.0	3.2X47	

- Material: PE
- Color: Grey
- With nail inserted, Steel nail for Masonry.
- Hook shape design to hold the cable and tube.

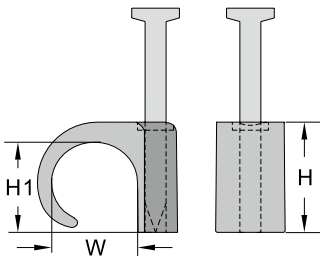



1012 KSS DOUBLE NAIL CABLE CLIP

UNIT : mm



Item No.	W	H1	H	Suitable Wires	Nails	Packing
DNF-13	12.5	5.3	8.0	#14/2,14/3,12/2	1.86X31	100 pcs
DNF-17	17.7	11.5	14.7		2.0X44	
DNF-19	18.7	5.3	8.0	#12/3,10/2,10/3	1.86X31	
DNF-24	24.0	13.6	17.1		2.0X44	50 pcs
DNF-37	36.8	22.5	26.1		2.3X50	

- Material: PE
- With nail inserted, Steel nail for Masonry.
- Color: White (others available upon request)
- Double nails ensure cable firmly in place.

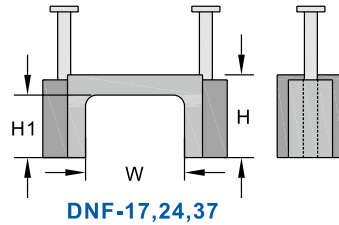
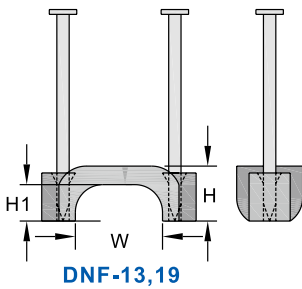

1022 KSS DOUBLE NAIL CABLE CLIP



UNIT : mm



Item No.	W	H1	H	Suitable wire	Nails	Packing
DNC-06	17.0	17.7	21.5	3/8" PVC PIPE	2.0X44	50 pcs
DNC-10	32.0	33.5	40.0	1" PVC PIPE	3.6X56	20 pcs
DNC-12	40.0	41.0	50.0	1 1/4" PVC PIPE	4.0X68	
DNC-15	50.3	50.3	48.3	1 1/2" PVC PIPE	4.0X78	
DNC-20	62.0	62.0	71.0	2" PVC PIPE	4.5X97	

- Material: PE
- With nail inserted, Steel nail for Masonry.
- Color: Grey (others available upon request)
- Double nails ensure cable firmly in place.

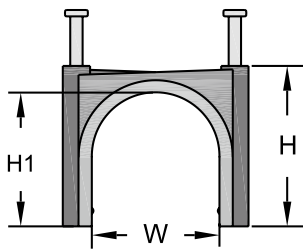

1023 KSS COATED COPPER TUBE CLIP



UNIT : mm



Item No.	W	H1	H2	H	Suitable for coated copper tube	Nails	Packing
MNC-23	43.5	26.0	21.5	33.0	2~3	4.0 × 50	50 pcs
MNC-24	50.5	34.5	23.0	42.0	2~4	4.0 × 68	
MNC-25	53.0	38.0	21.5	45.0	2~5	4.0 × 68	25 pcs
MNC-35	57.5	38.3	24.0	45.7	3~5	4.0 × 68	
MNC-46	69.3	41.3	32.0	48.0	4~6	4.0 × 78	

- Material: PE
- With nail inserted, Steel nail for Masonry.
- Color: White (others available upon request)
- For coated copper pipe of air conditioner.

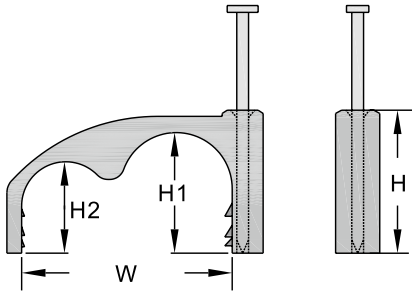

1030 KSS PIN PLUG



UNIT : mm



Item No.	W	L	Packing
PP-0518	5	18	100pcs

- Material: PE
- Color: Natural (others available upon request)

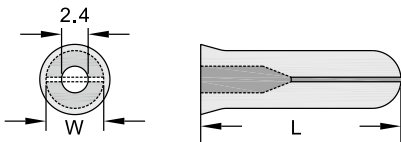

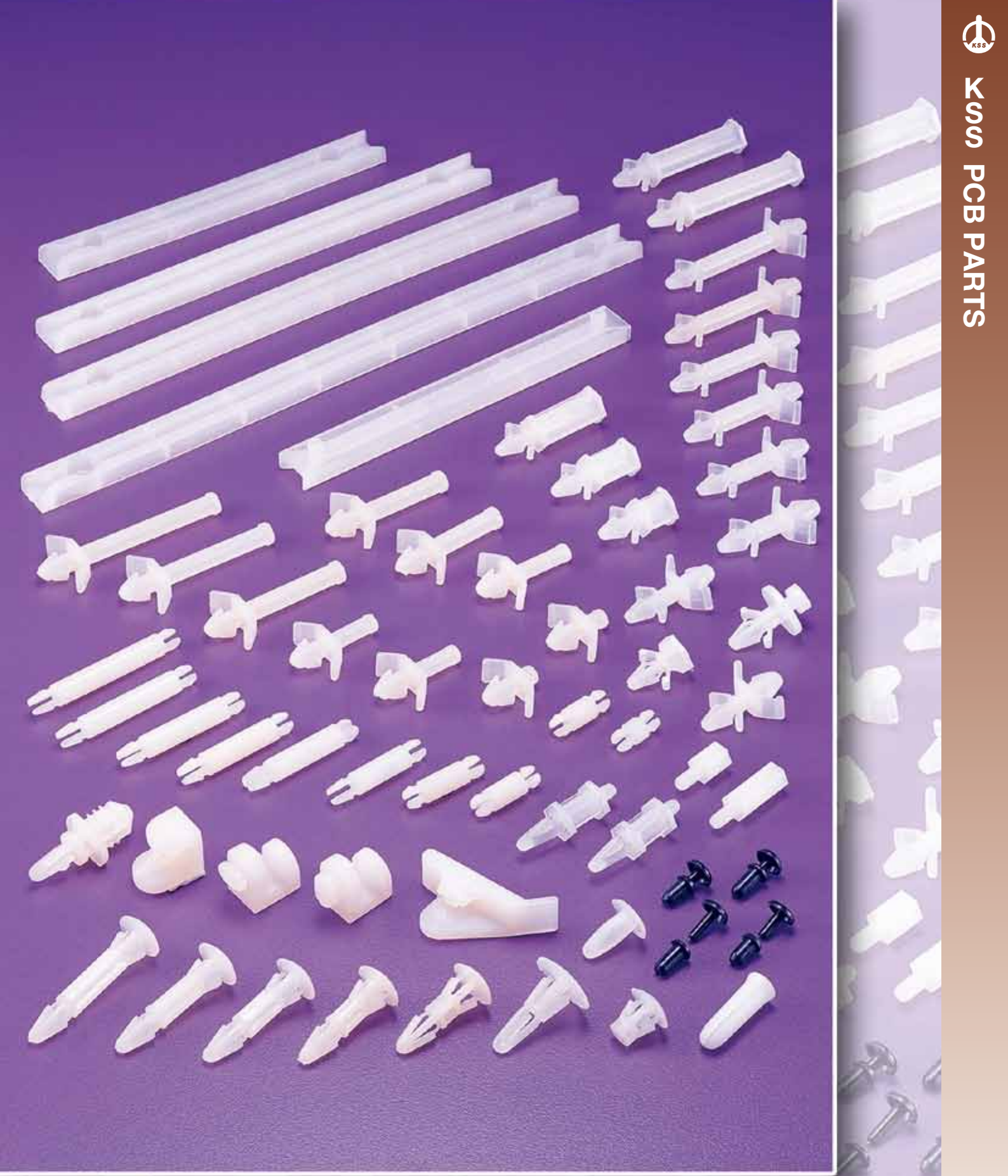

PCB PARTS

1101 KSS PCB SUPPORT



UNIT : mm



Item No.	A	PCB		Chassis		Packing
		hole	thickness	hole	thickness	
CS-0305	4.8 (3/16")	4.0	1.8	4.8	2.5	100 pcs
CS-0305S	4.8 (3/16")	3.0	2.0	3.0	2.0	
CS-0406	6.4 (1/4")	4.0	1.8	4.8	2.5	
CS-0406S	6.4 (1/4")	4.0	2.3	4.8	2.0	
CS-0610	9.3 (3/8")	4.0	1.8	4.8	2.5	
CS-0813	12.7 (1/2")	4.0	1.8	4.8	2.5	
CS-1016	15.9 (5/8")	4.0	1.8	4.8	2.5	
CS-1219	19.1 (3/4")	4.0	1.8	4.8	2.5	
CS-1422	22.2 (7/8")	4.0	1.8	4.8	2.5	
CS-1625	25.4 (1")	4.0	1.8	4.8	2.5	
CS-1828	28.5 (1 1/8")	4.0	1.8	4.8	2.5	
CS-2236	35 (1 3/8")	4.0	1.8	4.8	2.5	
CS-2236L	35 (1 3/8")	4.8	1.8	4.8	2.5	

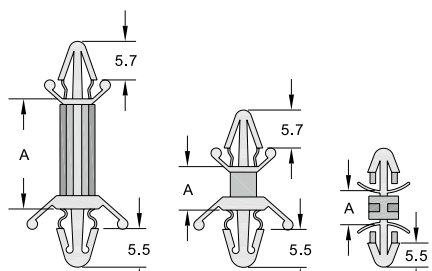

Standard design CS-0305,0406 CS-0305S

- Material: UL approved Nylon 66, 94V-2
- Color: Natural
- Feature: Easy to install / unload by hand, without tool. Pre-drill the hole on P.C Board and chassis before usage. Double locking design ensure that once support inside the panel cannot be removed accidentally, simply to push - through.

1101 KSS PCB SUPPORT



UNIT : mm



Item No.	A	PCB		Chassis		Packing
		hole	thickness	hole	thickness	
CS-0305L	5.4	4.0	2.4	4.0	2.4	100 pcs

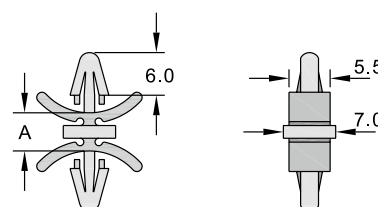

- Material: UL approved Nylon 66, 94V-2
- Color: Natural

1101 KSS PCB SUPPORT



UNIT : mm



Item No.	A	PCB		Chassis		Packing
		hole	thickness	hole	thickness	
MCS-6	6.0	4.0	1.8	4.8	2.0	100 pcs
MCS-8	7.8	4.0	1.7	4.8	5.0	
MCS-9	9.4	4.0	1.6	4.8	2.0	
MCS-12	11.5	4.0	1.7	4.8	5.0	
MCS-19	19.0	4.0	2.0	4.8	2.0	

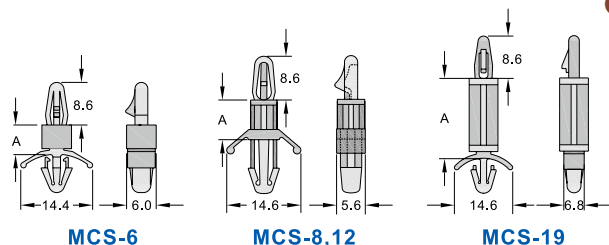

MCS-6 MCS-8,12 MCS-19

- Material: UL approved Nylon 66, 94V-2
- Color: Natural

1102 KSS PCB SUPPORT

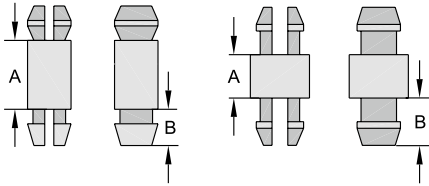

UNIT : mm

Standard design
SP-3S

Item No.	A	B	PCB		Chassis		Packing
			hole	thickness	hole	thickness	
SP-3	3.2	3.8	4.0	1.6	4.0	1.6	100 pcs
SP-3S	3.2	3.6	3.2	1.6	3.2	1.6	
SP-6	6.3	3.8	4.0	1.6	4.0	1.6	
SP-8	8.0	3.8	4.0	1.6	4.0	1.6	
SP-10	10.5	3.8	4.0	1.6	4.0	1.6	
SP-13	12.7	5.6	4.0	1.6	4.0	1.6	
SP-16	15.9	5.6	4.0	1.6	4.0	1.6	
SP-17	16.5	5.6	4.0	1.6	4.0	1.6	
SP-19	19.1	5.6	4.0	1.6	4.0	1.6	
SP-22	22.2	5.6	4.0	1.6	4.0	1.6	
SP-25	25.4	5.6	4.0	1.6	4.0	1.6	

- Material: UL approved Nylon 66,94V-2
- Color: Natural
- Pre-drill the hole on P.C. board and chassis before usage. Easy to install / unload by hands, without tool.
- For application where the space is limited and extra height is prohibited.

1102 KSS PCB SUPPORT

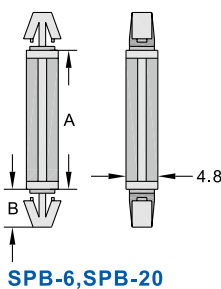
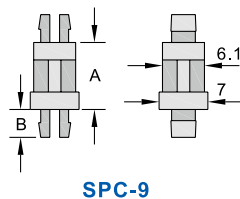
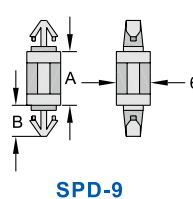
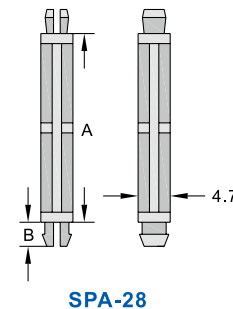

UNIT : mm

SPB-6,SPB-20

SPC-9

SPD-9

SPA-28

Item No.	A	B	PCB		Chassis		Packing
			hole	thickness	hole	thickness	
SPB-6	6.2	5.5	4.0	1.8	4.0	1.8	100 pcs
SPC-9	9.3	4.0	4.0	1.6	4.0	1.6	
SPD-9	9.5	5.5	3.5	1.8	3.5	1.8	
SPB-20	20.0	5.5	4.0	1.8	4.0	1.8	
SPA-28	28.2	3.6	3.6	1.6	3.8	1.6	

- Material: UL approved Nylon 66, 94V-2
- Color: Natural

1102 KSS PCB SUPPORT



UNIT : mm



Item No.	A	PCB		Chassis		Packing
		hole	thickness	hole	thickness	
LCA-14	13.6	2.5	2.0	3.0	1.7	100 pcs

- Material: UL approved Nylon 66, 94V-2
- Color: Natural

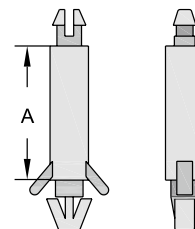

1102 KSS PCB SUPPORT



UNIT : mm



Item No.	A	B	PCB		Chassis		Packing
			hole	thickness	hole	thickness	
DS-18	18.2	3.7	2.5	1.6	2.5	1.5	100 pcs

- Material: UL approved Nylon 66, 94V-2
- Color: Natural

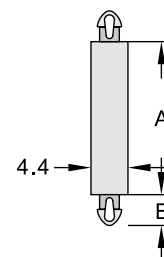

1103 KSS SCREW FASTENED PCB SUPPORT



UNIT : mm



Item No.	A	PCB		Chassis	Packing
		hole	thickness	thickness	
CS-5	4.9	4.0	2.0	3.0	100 pcs
CS-10	9.6				
CS-13	12.7				
CS-19	19.1				
CS-28	28.5				
CS-35	35.0				
CSA-14	13.9			2.5	

- Material: UL approved Nylon 66, 94V-2
- Color: Natural
- Pre-drill the hole on chassis, and fixed by #6 screw.

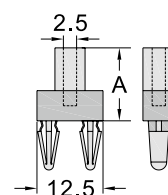
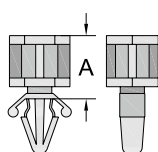

CS-TYPE

CSA-14



CSA-14

1104 KSS PCB SUPPORT

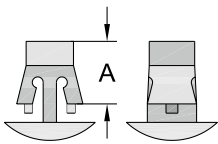
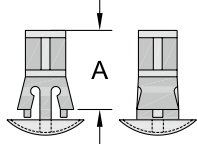

UNIT : mm

RLS-5,6,10

RLS-8,9,12,14,18

Item No.	A	PCB		Packing
		hole	thickness	
RLS-5	5.0	5.5	1.8	100 pcs
RLS-6	6.4			
RLS-8	8.0			
RLS-9	9.8			
RLS-10	10.1			
RLS-12	12.0			
RLS-14	14.0			
RLS-18	18.0			

- Material: UL approved Nylon 66, 94V-2
- Color: Natural

1104 KSS PCB SUPPORT

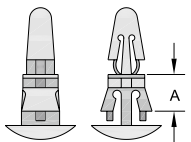
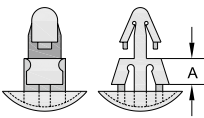
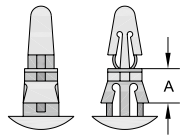
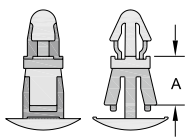
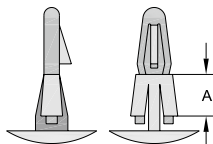
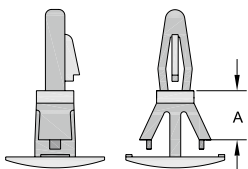
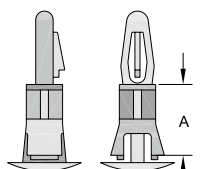

UNIT : mm

Standard design

RS-3,6B

RS-10,10S,12H

RS-6C,12C

RS-8S

RS-6A,7A,10A

RS-10L

Item No.	A	PCB		Chassis		Packing
		hole	thickness	hole	thickness	
RS-2D	2.5	4.0	1.8	5.0	3.2	100 pcs
RS-3	3.5	4.0	1.8	5.5	1.4	
RS-5	5.0	4.0	1.8	5.5	1.8	
RS-5D	5.0	4.0	1.8	5.0	3.2	
RS-5S	5.0	3.0	1.7	4.8	2.0	
RS-6	6.1	4.0	1.8	5.5	1.8	
RS-6A	5.6	4.0	1.6	6.4	1.8	
RS-6B	5.6	4.0	1.8	6.4	1.4	
RS-6C	6.1	4.2	1.8	5.2	1.4	
RS-6S	5.9	3.5	1.8	5.3	1.8	
RS-7A	6.6	4.0	1.6	5.4	1.6	
RS-8	8.0	4.0	1.8	5.5	1.8	
RS-8S	6.1	4.0	1.6	5.5	1.8	
RS-10	9.8	4.0	1.8	5.5	1.8	
RS-10S	9.3	4.0	1.6	5.5	1.8	
RS-10A	9.8	4.0	1.6	5.4	1.8	
RS-10L	9.8	4.0	1.6	5.5	1.8	
RS-12	12.0	4.0	1.8	5.5	1.8	
RS-12C	12.1	4.2	1.8	5.2	1.4	
RS-12H	11.8	4.0	1.6	5.5	1.8	
RS-14	14.0	4.0	1.8	5.5	1.8	
RS-18	18.0	4.0	1.8	5.5	1.8	

- Material: UL approved Nylon 66, 94V-2
- Color: Natural
- Stand on design to lock Print circuit board.
- No tool is needed and easy to fix or remove from PC board.

1105 KSS CIRCUIT BOARD EJECTOR



UNIT : mm



Item No.	Dimension	Packing
BE-1	As Figure	100 pcs

- Material: UL approved Nylon 66, 94V-2
- Color: Natural
- Pre-drill hole on PCB: 2.5-2.6mm. and press directly into PC board.
- Suitable for PCB thickness 1.6mm

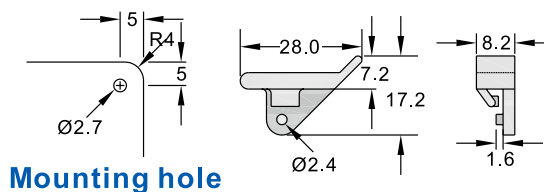

1106 KSS BLIND HOLD PCB SUPPORT



UNIT : mm



Item No.	A	PCB		Mounting hole	Packing
		hole	thickness		
BCS-5	5.2	4.4	2.0	7.6	100 pcs

- Material: UL approved Nylon 66, 94V-2
- Color: Natural

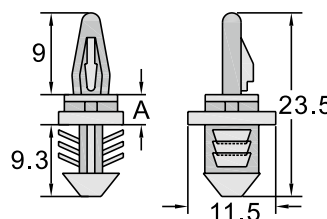

1106 KSS SCREW FASTENED PCB SUPPORT



UNIT : mm



Item No.	A	PCB		Packing
		hole	thickness	
SCS-10	10.1	4.0	2.0	100 pcs
SCS-25	25.4			

- Material: UL approved Nylon 66, 94V-2
- Color: Natural

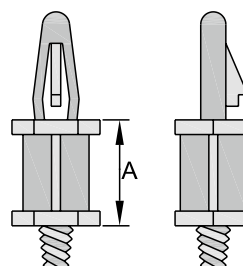

1107 KSS PUSH SPACER



UNIT : mm

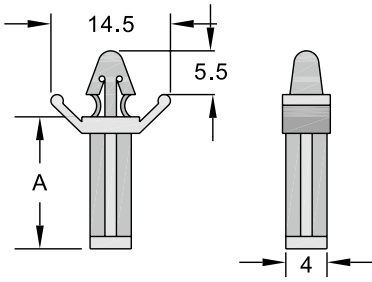

Item No.	A	PCB		Packing
		hole	thickness	
PS-5	4.8	4.8	2.0	100 pcs
PS-6	6.4			
PS-10	9.6			
PS-13	12.7			
PS-16	15.9			
PS-19	19.1			
PS-22	22.2			
PS-25	25.4			
PS-28	28.5			
PS-36	35.0			

- Material: UL approved Nylon 66, 94V-2
- Color: Natural
- Pre-drill the hole on chassis board and press push spacer into it.
- To support and stabilize PC board

1108 KSS PUSH SPACER



UNIT : mm

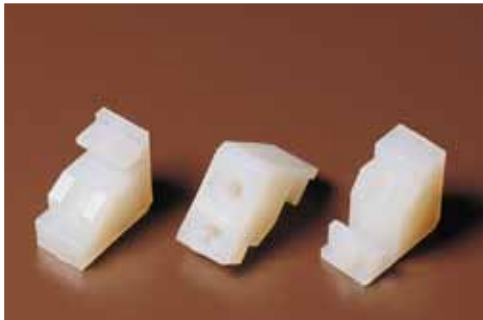

Item No.	A	B	C	D	Packing
EB-9	13.5	13.6	1.8	8.7	100 pcs

- Material: UL approved Nylon 66, 94V-2
- Color: Natural

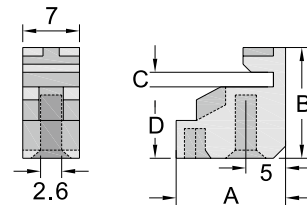

1108 KSS PCB EDGE SPACER



UNIT : mm

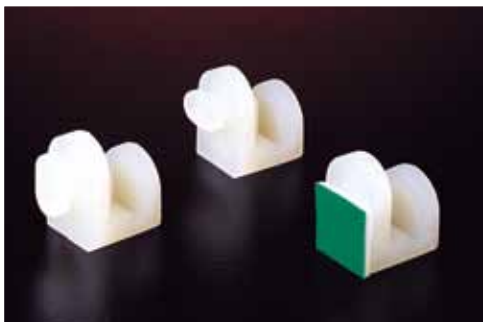

Item No.	A	B	C	D	E	Packing
ES-5A	5.4	2.2	5.5	10.3	9.5	100 pcs
ES-6A	6.0	1.9	9.0	10.8	8.7	
ES-6M	5.8	2.2	9.3	10.7	9.5	
ES-6P	6.0	1.9	9.0	10.8	8.7	
ES-6V	6.0	1.9	9.0	10.8	8.7	
ES-8U	8.4	2.0	6.7	13.3	9.8	

- Material: UL approved Nylon 66, 94V-2
- Color: Natural
- To stabilize PC board, easy to remove.

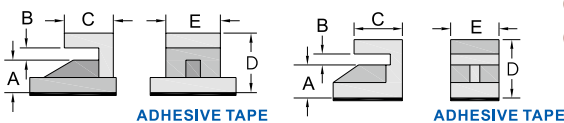

ES-5A

ES-6A

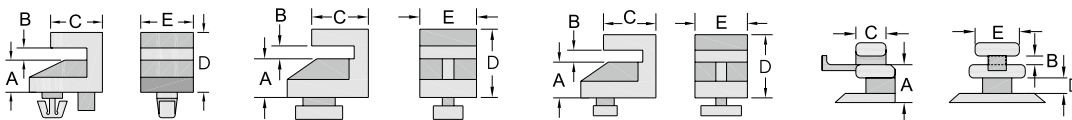

ES-6M

ES-6P

ES-6V

ES-8U

1109 KSS PCB SUPPORT



UNIT : mm



Item No.	A	PCB		Packing
		hole	thickness	
MS-6	6.4	4.0	2.0	100pcs

- Material: UL approved Nylon 66, 94V-2
- Color: Natural
- Drill holes on chassis board as shown.
- Push support into the larger hole and slide onto the smaller one to get fixed.
- To stabilize PC board, easy to remove.

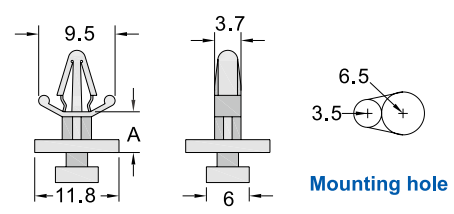

1109 KSS PCB SUPPORT



UNIT : mm



Item No.	A	B	C	PCB		Packing
				hole	thickness	
BMS-5	5.6	9.5	11.8	4.0	2.0	100 pcs
BMS-5B	5.6	9.5	9.7	4.0		
BMS-5L7	5.6	9.5	7.1	4.8		
BMS-5L	5.6	9.5	11.8	4.8		
BMS-7	6.5	9.5	11.8	4.0		
BMS-8	8.0	9.5	11.8	4.0		
BMS-11	11.0	9.0	12.0	4.0		
HMS-6	6.0	5.0	7.0	4.8		

- Material: UL approved Nylon 66, 94V-2
- Color: Natural, available in other colors.

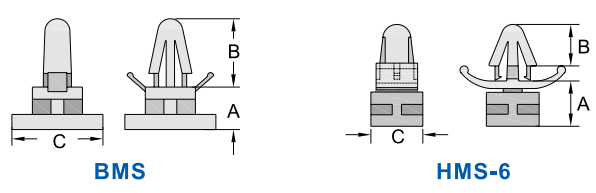

1109 KSS PCB SUPPORT



UNIT : mm



Item No.	A	PCB		Packing
		hole	thickness	
TMS-17	17.2	4.0	1.4	100pcs

- Material: UL approved Nylon 66, 94V-2
- Color: Natural, available in other colors.

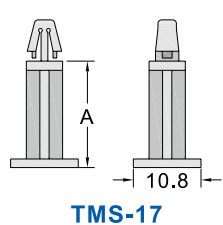

1109 KSS SELF-ADHESIVE PCB SUPPORT



UNIT : mm



Item No.	A	B	PCB		Packing
			hole	thickness	
MMS-2	2.2	14.9	3.2	1.8	100 pcs
MMS-21	21.3	17.9	4.0	1.8	

- Material: UL approved Nylon 66, 94V-2
- Color: Natural
- With adhesive tape.

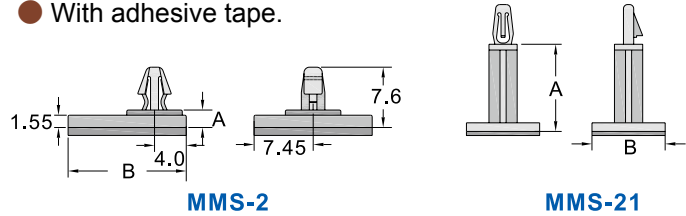

1109 KSS SELF-ADHESIVE PCB SUPPORT



UNIT : mm



Item No.	A	PCB		Packing
		hole	thickness	
MMR-5	4.8	3.2	1.6	100 pcs
MMR-6	6.4			
MMR-8	7.9			
MMR-9	9.5			
MMR-11	11.1			
MMR-13	12.7			
MMR-14	14.3			
MMR-16	15.9			

- Material: UL approved Nylon 66, 94V-2
- Color: Natural
- With adhesive tape.

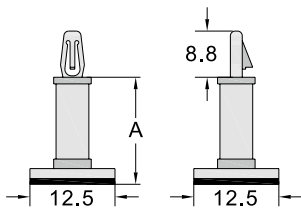

1110 KSS CIRCUIT BOARD TRACK



UNIT : mm



Item No.	A	B	C	D	E	F	G	Packing
BT-90A	89.5	78.0	2.0	4.5	9.7	1.5	3.0	100 pcs
BT-90	89.5	64.5	2.0	4.5	9.7	1.5	3.0	
BT-120	119.0	95.5	2.0	4.5	9.5	1.5	3.0	
BT-140	141.0	115.5	2.0	4.5	9.7	1.5	3.0	
BT-155A	154.0	141.0	2.0	4.6	6.6	1.3	3.3	
BT-160	160.5	135.5	2.0	4.5	9.7	1.5	3.0	
BT-160A	163.0	149.5	2.0	6.5	9.5	4.0	2.5	
BT-77DBK	77.0	67.0	1.4	6.0	6.6	1.5	3.0	

- ★ BT-90A, BT-155A, BT-160A with snap in design.
- Material: UL approved Nylon 66, 94V-2
- Color: Natural, available in other colors.
- To be fixed by 2 sets of 3mm flat-head screw.

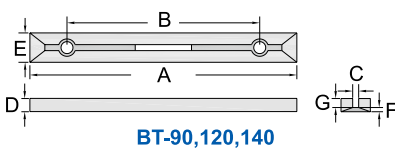

BT-90,120,140

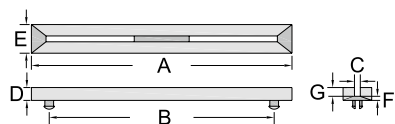

BT-90A, BT-155A

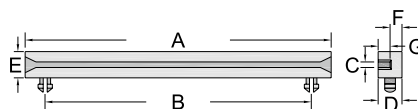

BT-77DBK

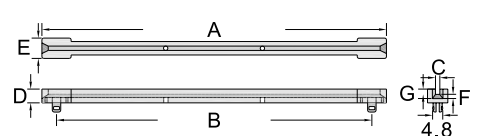

BT-160A

1111 KSS HEXAGONAL THREADED SPACER



UNIT : mm

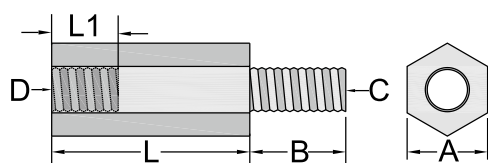

Item No.	A	B	C/D	L	L1	Packing
HTS-205	4.0	5	available nut M2X0.4	5	4.0	100 pcs
HTS-208	4.0	5		8	6.0	
HTS-210	4.0	5		10	6.0	
HTS-215	4.0	5		15	6.0	
HTS-306	5.6	6	available nut M3X0.5	6	5.3	
HTS-308	5.6	6		8	7.5	
HTS-310	5.6	6		10	6.5	
HTS-312	5.6	6		12.7	10.0	
HTS-315	5.6	6		15	10.0	
HTS-317	5.6	6		17	10.0	
HTS-318	5.6	6		18	10.0	
HTS-320	5.6	6		20	10.0	
HTS-322	5.6	6		22	10.0	
HTS-325	5.6	6		25	10.0	
HTS-330	5.6	6		30	10.0	
HTS-410	7.0	6		available nut M4X0.7	10.1	
HTS-413	7.0	6	13		7.0	
HTS-415	7.0	6	15		10.0	
HTS-419	7.0	6	19		10.0	
HTS-425	7.0	6	25		10.0	
HTS-430	7.0	6	30		10.0	

- Material: UL approved Nylon 66, 94V-2
- Color: Natural
- Application: Used crew and nut to isolate chassis board and PC board.
- Feature: can be extended by adding spacers.

1113 KSS HEXAGONAL TAPPED SPACER



UNIT : mm

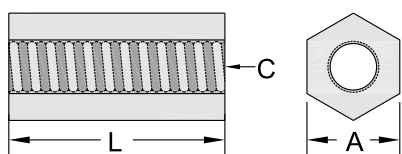

Item No.	L	A	C	Packing
HTP-306	6.0	5.5	available nut M3X0.5	100 pcs
HTP-308	8.0	5.5		
HTP-310	10.0	5.5		
HTP-312S	12.1	5.5		
HTP-312	12.7	5.5		
HTP-315	15.0	5.5		
HTP-318	18.0	5.5		
HTP-320	20.0	5.5		
HTP-322	22.0	5.5		
HTP-325	25.0	5.5		
HTP-330	30.0	5.5		

- Material: UL approved Nylon 66, 94V-2
- Color: Natural
- Application: Used crew and nut to isolate chassis board and PC board.

1114 KSS HEXAGONAL SPACER



UNIT : mm



Item No.	L	A	B	C	Packing
HTN-380	79	5.5	15	2.7	100 pcs

- Material: UL approved Nylon 66, 94V-2
- Color: Natural
- ※ No inner thread



1115 KSS PCB SUPPORT



UNIT : mm



Item No.	A	PCB		Chassis		Packing
		hole	thickness	hole	thickness	
KCS-0813V0	12.5	4.0	2.5	4.8	2.5	100 pcs

- Material: UL approved Nylon 66, 94V-0
- Color: White
- Function: To fix PC board.
- Feature: No tool is need, easy and quick install by hand.
- Application: Drill the hole on chassis board and install spacer on it, and fix the PC board.

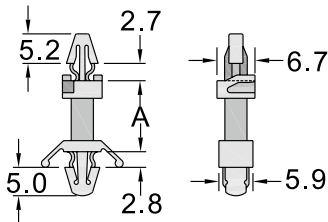

1116 KSS PCB SUPPORT



UNIT : mm



Item No.	A	B	C	D	Packing
SPS-6	6.5	3.9	7.0	6.0	100 pcs

- Material: UL approved Nylon 66, 94V-2
- Color: Natural
- Function: To fix PC board.
- Application: Fix on PC board, and fix by screw in another end.

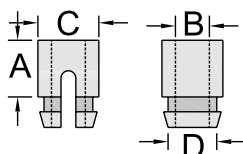

1117 KSS PCB SUPPORT



UNIT : mm



Item No.	A	H	Available Screw C	Packing
PB-10	9.6	29.6	M4 x 10mm	100pcs

- Material: UL approved Nylon 66, 94V-2
- Color: Natural

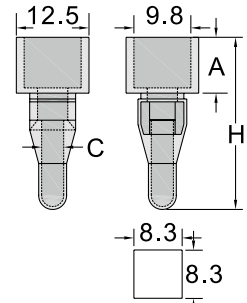

To fit hole

1118 KSS PCB SUPPORT



UNIT : mm



Item No.	A	H	Available Screw C	Packing
PST-18	19.0	25.8	#6-32UNC	100pcs

- Material: UL approved Nylon 66, 94V-2
- Color: Natural

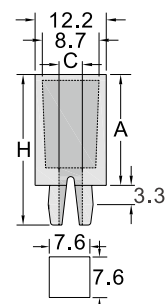

To fit hole

1119 KSS PCB SUPPORT



UNIT : mm



Item No.	A	Packing
HGS-7	7.0	100 pcs
HGS-8	7.9	
HGS-11	7.0	

- Material: UL approved Nylon 66, 94V-2
- Color: Natural
- Feature: Installation tool is no need; can use hand to make quick installation.
- Application: Drill the hole on chassis board and install spacer on it, and fix the PC board.

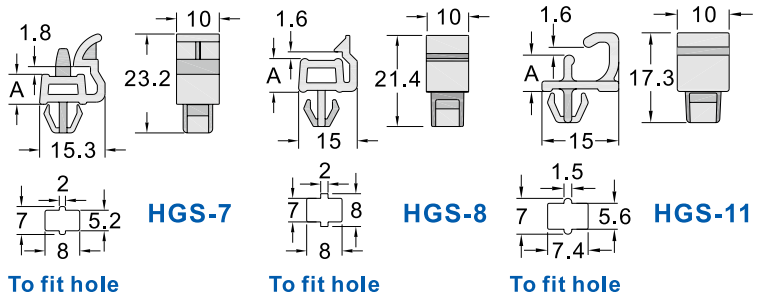

To fit hole

To fit hole

To fit hole

1120 KSS PCB SUPPORT



UNIT : mm



Item No.	A	Packing
GS-10	10.0	100 pcs

- Material: UL approved Nylon 66, 94V-2
- Color: Natural

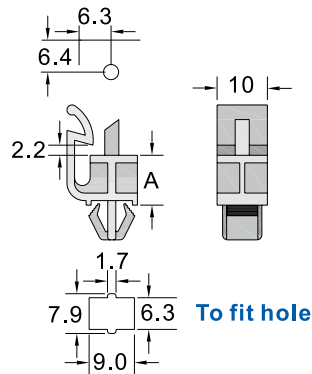

1120 KSS PCB SUPPORT



UNIT : mm

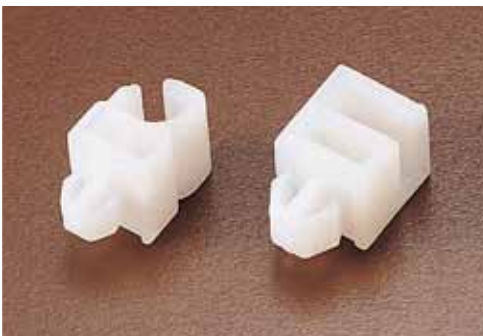

Item No.	A	Packing
SWS-1	11.0	100 pcs
SWS-2	10.0	

- Material: UL approved Nylon 66, 94V-2
- Color: Natural

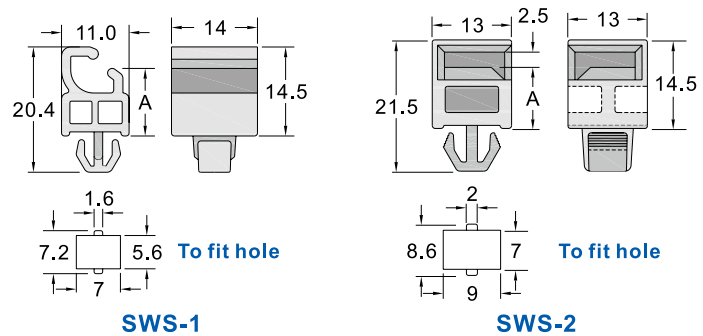

1121 KSS PCB SUPPORT



UNIT : mm



Item No.	A	PCB		Chassis		Packing
		hole	thickness	hole	thickness	
LCS-0610V0	9.4	4.0	2.0	4.8	2.0	100 pcs

- Material: UL approved Nylon 66, 94V-0
- Color: White

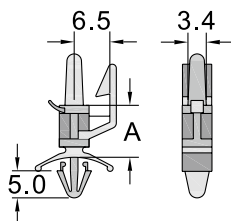

1121 KSS PCB SUPPORT



UNIT : mm



Item No.	A	PCB		Chassis		Packing
		hole	thickness	hole	thickness	
LCS-10A	9.0	4.0	1.8	4.0	1.8	100 pcs

- Material: UL approved Nylon 66, 94V-2
- Color: Natural

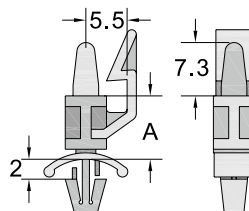

1121 KSS PCB SUPPORT



UNIT : mm



Item No.	A	Packing
LCL-8WE6	7.9	100pcs

- Material: UL approved Nylon 66, 94V-2
- Color: White

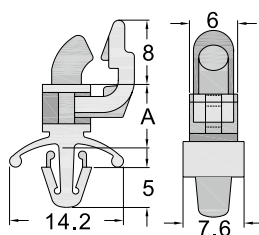

1123 KSS PCB SUPPORT



UNIT : mm

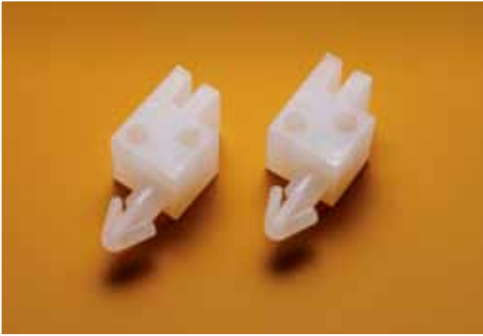

Item No.	Dimension	PCB		Packing
		hole	thickness	
PCU-23	As Figure	4.5	4.0	100pcs

- Material: UL approved Nylon 66, 94V-2
- Color: Natural

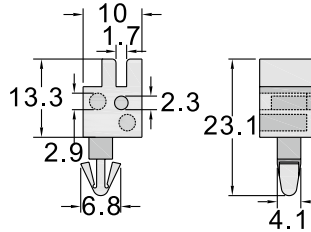

1125 KSS SNAP RIVET



UNIT : mm



Item No.	A	B	Chassis thickness C	Packing
SR-355K	3.0	5.5	2.5-4.0	1000 pcs
SR-365K	3.0	6.5	4.0-5.0	
SR-380K	3.0	8.0	5.5-6.5	
SR-450K	4.0	5.0	2.2-3.5	
SR-465K	4.0	6.5	4.0-5.0	
※SR-0612K	6.2	12.3	7.0-10.0	
※SR-0815K	8.0	14.0	7.0-12.0	

- Material: UL approved Nylon 66, 94V-2
- Color: Black, available in other colors.
- Rivet post pressure expands legs for fast and permanent fastening.
- ※ Male-and-female integrated design.



SR-0612K & SR-0815K

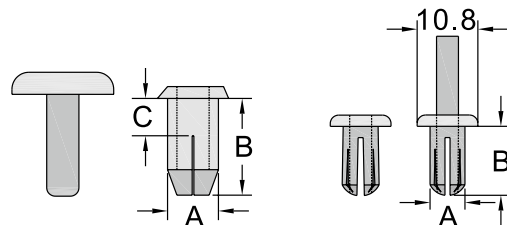

Standard design

SR-0612K & SR-0815K

1126 KSS SNAP RIVET



UNIT : mm



Item No.	A	B	C	D	E	F	G	Packing
SR-0813	10.7	7.0	5.5	7.8	15.8	25.1	15.6	100 pcs
SR-0910	10.8	7.6	1.6	8.1	15.8	20.9	11.4	

- Material: UL approved Nylon 66, 94V-2
- Color: Black, available in other colors.
- Function: To join chassis board and PC board.

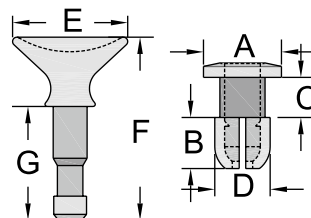

1127 KSS SCREW ON RIVET



UNIT : mm



Item No.	A	B	C	D	E	F	Panel	Packing
SR-611	6.0	11.0	14.0	2.4	8.0	1.0	2~3.5	100 pcs
SR-611R	6.6	11.0	16.0	1.4	8.4	2.5	1.5~6	
SR-614	6.3	14.2	15.1	1.95	10.2	1.65	3~4.5	

- Material: UL approved Nylon 66, 94V-2
- Color: Black, available in other colors.
- Drill holes on chassis board and press push rivet into it.
- Function: To join chassis board and PC board.

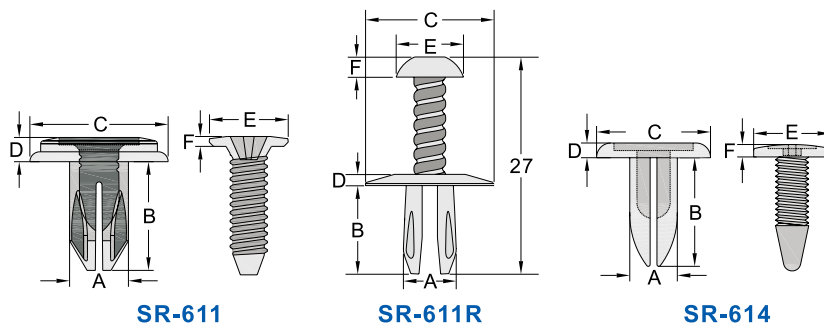

SR-611

SR-611R

SR-614

1128 KSS PUSH RIVET



UNIT : mm



Item No.	Color	W	W1	D	H	H1	Packing
SR-0313	Natural	3.2	3.2	6.3	14.9	12.9	100 pcs
SR-0512BK	Black	5.1	4.7	11.2	13.6	12.5	
SR-1315	Natural	4.6	4.6	12.9	17.0	14.9	
SR-0816BK	Black	8.0	8.0	15.0	17.8	15.8	
SR-0817BK	Black	7.5	7.5	15.0	19.3	16.8	
SR-0420BK	Black	3.8	3.8	18.0	22.5	20.0	
SR-25BK	Black	6.6	6.6	17.85	27.2	25.2	

- Material: UL approved Nylon 66, 94V-2
- Function: To join chassis board and PC board.

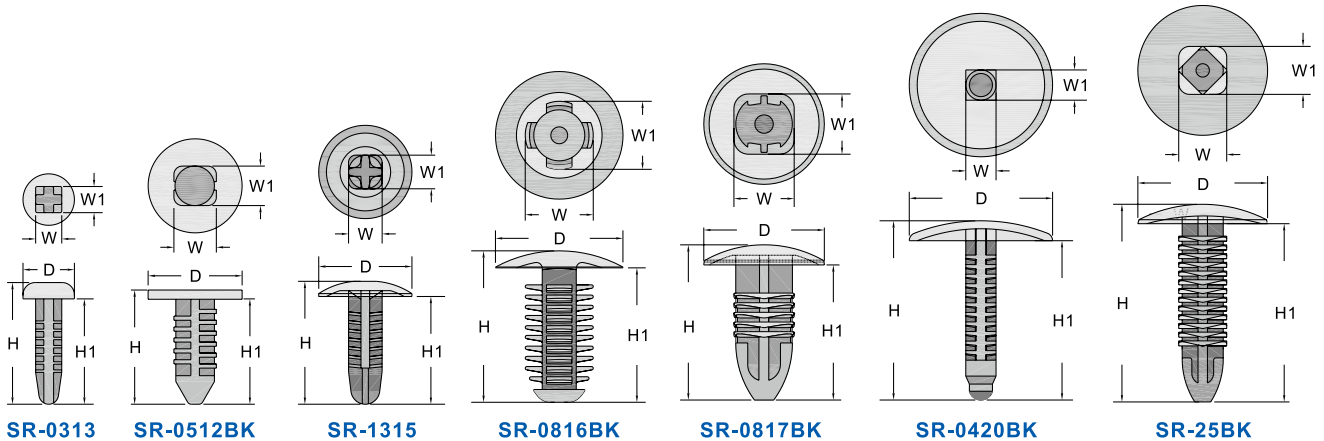

1129 KSS SNAP RIVET



UNIT : mm



Item No.	A	B	C	D	E	F	G	Packing
SR-0809	8.5	7.4	1.9	6.3	7.1	13.6	11.1	100 pcs
SR-0810	8.5	7.4	2.1	6.3	8.1	18.4	11.9	
SR-1010	10.8	7.8	2.6	8.0	9.2	19.1	12.9	

- Material: UL approved Nylon 66, 94V-2
- Color: Natural
- Function: To join chassis board and PC board.

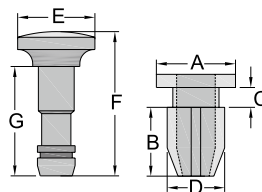

1130 KSS CANOE RIVET



UNIT : mm



Item No.	A	B	H	Panel	Packing
SN-0309	3.8	7.4	8.7	3~6	100 pcs
SN-0511	4.9	9.2	11.0	2~5	
SN-0716	7.5	12.9	16.0	3~6	

- Material: UL approved Nylon 66, 94V-2
- Color: Natural
- Function: To join chassis board and PC board.

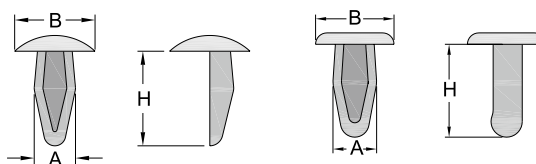

SN-0309

SN-0511, SN-0716

1131 KSS SNAP RIVET



UNIT : mm



Item No.	A	B	Panel	Packing
SN-0305	3.1	5	5	100pcs

- Material: UL approved Nylon 66, 94V-2
- Color: Natural

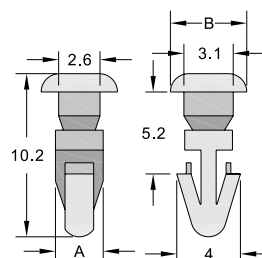

1132 KSS DRIVE RIVET



UNIT : mm



Item No.	A	B	H	Panel	Packing
DN-0715	6.5	11	15	1~5.5	100pcs

- Material: UL approved Nylon 66, 94V-2
- Color: Natural
- POM products available

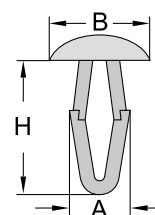

1136 KSS DOOR LOCK



UNIT : mm



Item No.	W1	W2	H	Packing
DR-1	8.2	10.6	14.7	100pcs

- Material: UL approved Nylon 66, 94V-2
- Color: Natural

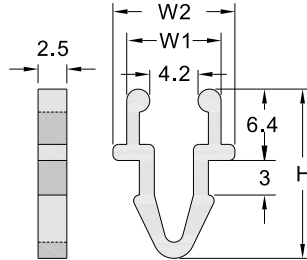

1140 KSS ROUND SPACER



UNIT : mm



Item No.	A	B	C	Packing
RSP-1607	19	16.5	6.9	100pcs

- Material: PE
- Color: Natural

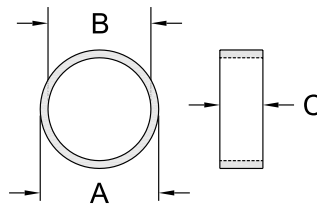

1141 KSS ROUND SPACER



UNIT : mm



Item No.	A	B	C	Packing
RSP-0203	4.0	2.1	2.5	100pcs
RSP-0508	7.5	4.6	8.0	
RSP-0510	10.0	5.4	10.0	

- Material: UL approved Nylon 66, 94V-2
- Color: Natural
- Function: To spacer chassis board and PC board.

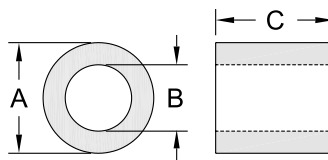

1141 KSS ROUND SPACER



UNIT : mm

NEW

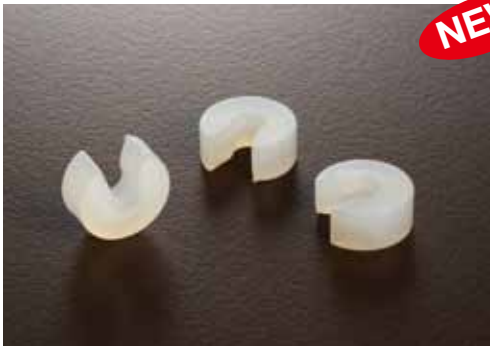

Item No.	A	B	C	Packing
RSC-0412	12.2	3.7	5	100pcs

- Material: UL approved Nylon 66, 94V-2
- Color: Natural
- Function: To spacer chassis board and PC board.

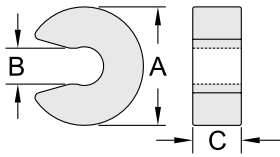

1151 KSS PCB HINGE



UNIT : mm



Item No.	Dimension	PCB		Packing
		hole	thickness	
PH-17	As Figure	4	1.6	100pcs

- Material: UL approved Nylon 66, 94V-2
- Color: Natural

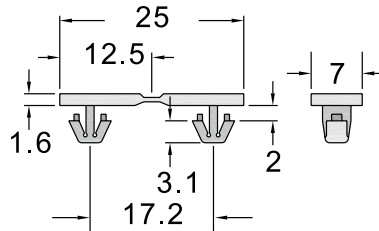



FASTENERS

1201 KSS WIRE SADDLE



UNIT : mm



Item No.	Dimension				Mounting Hole	Thickness	Packing
	H	A	B	W			
JWS-0402V0	5.1	4.5	2.8	5.0	3.5	0.5~1.6	100 pcs
JWS-0504V0	6.3	5.3	4.4	5.1	3.5	0.5~1.6	

- Material: UL approved Nylon66, 94V-0
- Color: White

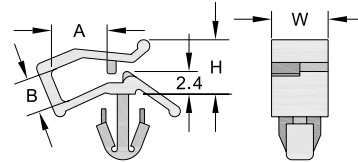

1201 KSS WIRE SADDLE



UNIT : mm



Item No.	Dimension				Mounting Hole	Thickness	Packing
	H	A	B	W			
JWB-0706	9.7	7.7	6.4	4.0	3.0	1.6	100 pcs
JWS-0605V0	7.8	6.6	5.0	3.8	3.5	1.6	
JWS-0706V0	9.7	7.9	6.4	3.8	3.5	1.6	
JWS-0910	13.4	9.3	10.7	4.0	3.5	1.0	

- Material: JWS-0605V0, JWS-0706V0, UL approved Nylon66, 94V-0
- Color: White
- Material: JWB-0706, JWS-0910, UL approved Nylon66, 94V-2
- Color: Natural

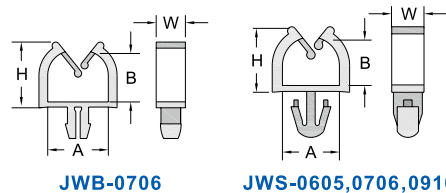

1201 KSS LOCKING WIRE SADDLE



UNIT : mm



Item No.	Dimension				PCB		Packing
	H	A	B	W	hole	thickness	
KWS-0	9.0	13.0	4.0	11.0	4.8	2.0	100 pcs
KWS-1	14.2	19.0	10.5	11.0	4.8	2.0	
KWS-2	23.0	27.0	19.0	11.0	4.8	2.0	
KWS-2L	15.0	18.0	12.0	10.4	4.8	4.0	
KWS-3	31.1	35.8	28.0	11.0	4.8	2.0	

- Material: UL approved Nylon 66, 94V-2.
- Color: Natural
- For directing and gathering cables at low cost. Locking into 4.8mm diameter mounting hole with fingertip pressure. Self adjust to various panel thickness.

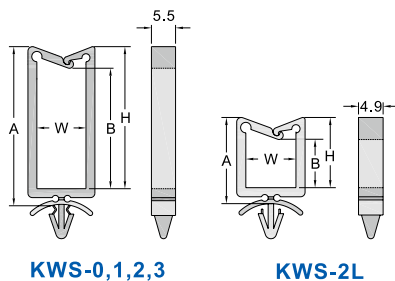



UNIT : mm

1201 KSS WIRE SADDLE



Item No.	Dimension				PCB		Packing
	H	A	B	W	hole	thickness	
NEW PWS-1013	13.8	17.8	10.4	4.8	4.8	2.3	100pcs
PWS-1715	15.0	16.7	23.0	5.0	4.8	2.4	

- Material: UL approved Nylon 66, 94V-2.
- Color: Natural
- Application: Pre-drill 4.8mm hole on chassis board and fix the wire saddle, lock the wire in saddle with fingertip pressure. Can directing and gathering cable in and direction.

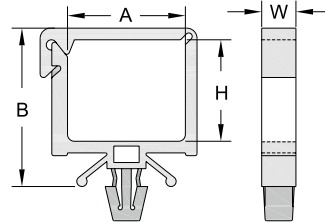

1201 KSS WIRE SADDLE



UNIT : mm



Item No.	Dimension			PCB		Packing
	H	A	B	hole	thickness	
PWS-2824	35.3	27.6	24	4.8	2.0	100pcs

- Material: UL approved Nylon 66, 94V-2.
- Color: Natural

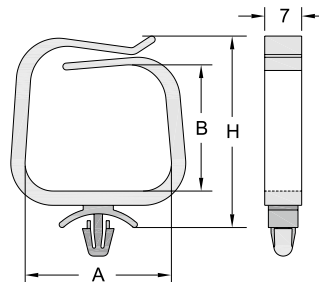

1202 KSS LOCKING WIRE SADDLE



UNIT : mm



Item No.	Dimension	PCB		Packing
		hole	thickness	
WS-1522	As Figure	4.5	2.0	100pcs

- Material: UL approved Nylon 66, 94V-2.
- Color: Natural

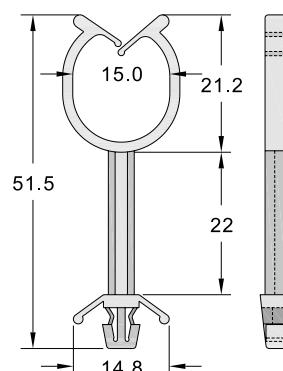

1202 KSS LOCKING WIRE SADDLE



UNIT : mm

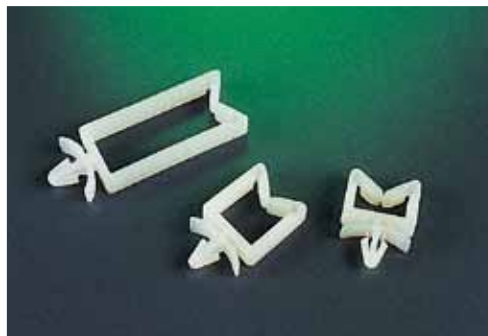

Item No.	Dimension				PCB		Packing
	H	A	B	W	hole	thickness	
KWS-0N	9.2	12.7	4.0	11.0	4.8	2.0	100 pcs
KWS-1N	14.8	17.9	9.6	11.0	4.8	2.0	
KWS-2N	23.4	26.9	18.2	11.0	4.8	2.0	
KWS-3N	31.3	34.8	26.2	11.0	4.8	2.0	
KWS-1114	17.8	21.2	13.7	10.7	4.8	2.4	

- Material: UL approved Nylon 66, 94V-2.
- Color: Natural
- For directing and gathering cables at low cost. Locking into 4.8mm hole with fingertip pressure.

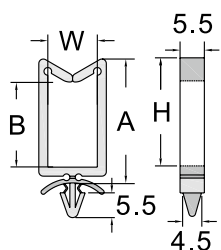

KWS-0N,1N,2N,3N

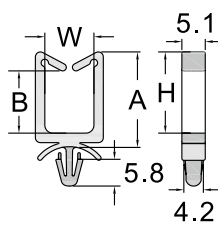

KWS-1114

1202 KSS LOCKING WIRE SADDLE



UNIT : mm



Item No.	Dimension			PCB		Packing
	H	A	B	hole	thickness	
KWS-0506	5.4	5.0	9.0	4.8	3.0	100 pcs
KWS-1106	5.4	10.5	13.0	4.8	1.6	
KWS-1110	9.8	10.9	14.4	As Figure	2.2	
KWS-1308	8.5	12.7	17.2	5.8	1.6	
KWS-1310	9.9	13.0	18.8	As Figure		
KWS-2314	13.6	22.9	28.3	4.8	3.4	

- Material: UL approved Nylon 66, 94V-2.
- Color: Natural
- Application: Pre-drill hole on chassis board and fix the wire saddle, lock the wire in saddle with fingertip pressure. Can directing and gathering cable in and direction.

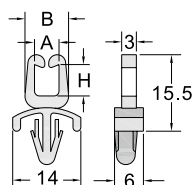

KWS-0506

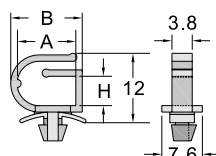

KWS-1106

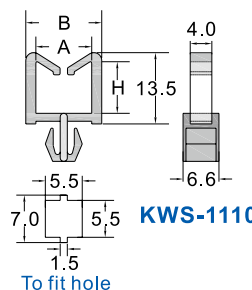

KWS-1110

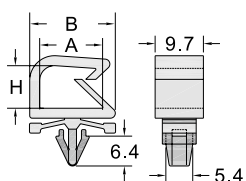

KWS-1308

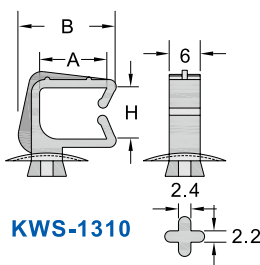

KWS-1310

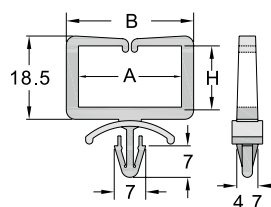

KWS-2314

1202 KSS EDGING WIRE SADDLE



UNIT : mm



Item No.	Dimension								Packing
	A	B	C	D	L	L1	W	W1	
HL-1109	15.6	14.0	12.3	3.0	40.0	8.8	18.5	11.1	100 pcs
HL-1817	23.5	21.0	21.0	3.0	56.8	16.8	25.4	18.0	

- Material: UL approved Nylon 66, 94V-2.
- Color: Black

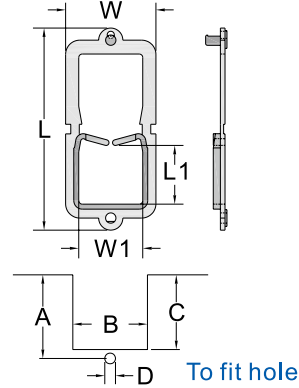

1202 KSS EDGING WIRE SADDLE



UNIT : mm



Item No.	Dimension	Packing
ES-16	As Figure	100pcs

- Material: UL approved Nylon 66, 94V-2.
- Color: Natural

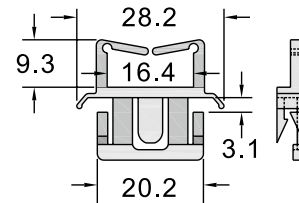

1202 KSS EDGING WIRE SADDLE



UNIT : mm



Item No.	Dimension				Packing
	H	H1	W	W1	
ES-1207V0	12.3	7.3	19.3	11.8	100pcs

- Material: UL approved Nylon 66, 94V-0
- Color: White

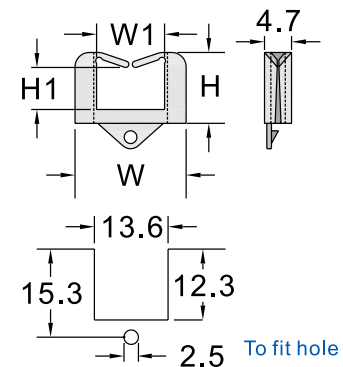

1202 KSS WIRE SADDLE



UNIT : mm

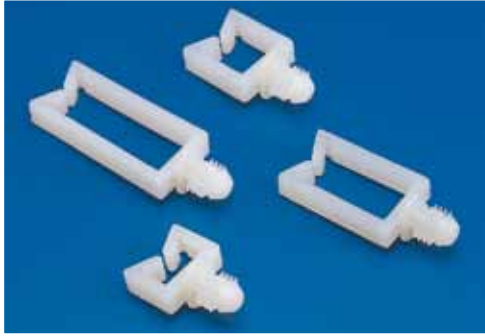

Item No.	Dimension		Mounting Hole	Min Depth	Packing
	H	H1			
BWS-1106	13.0	5.0	7.8	8.7	100 pcs
BWS-1112	18.3	10.3			
BWS-1120	27.2	19.2			
BWS-1128	35.6	27.8			

- Material: UL approved Nylon 66, 94V-2
- Color: Natural

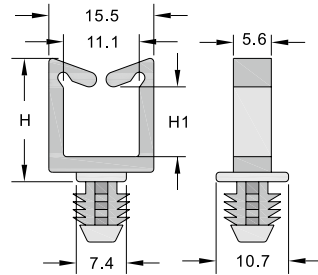

1203 KSS N TYPE WIRE SADDLE



UNIT : mm



Item No.	Dimension				Packing
	A	B	C	D	
PCC-1	6.3	10.6	10.7	7.5	100pcs

- Material: UL approved Nylon 66, 94V-2.
- Color: Natural
- Locking into 5.6mm diameter mounting hole. Open gate to insert cable, release to close.

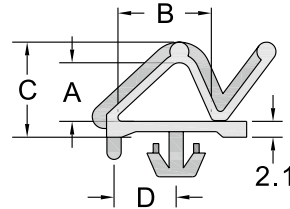

1204 KSS WIRE SADDLE



UNIT : mm



Item No.	Dimension					Packing
	A	B	C	D	E	
TWS-3	8.4	16.3	8.8	24.8	27	100pcs

- Material: UL approved Nylon 66, 94V-2.
- Color: Natural

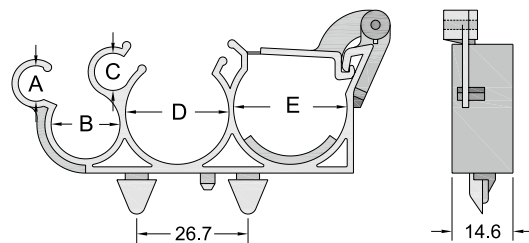

1204 KSS WIRE SADDLE



UNIT : mm



Item No.	Dimension		PCB		Packing
	A	B	hole	thickness	
RH-5	5.1	8.0	5.5	2.0	100 pcs
RH-6	6.2	9.5	8.0	1.8	
RH-8	7.5	11.5	6.2	2.0	
RH-9	9.6	18.0	9.5	2.0	

- Material: UL approved Nylon 66, 94V-2.
- Color: Natural

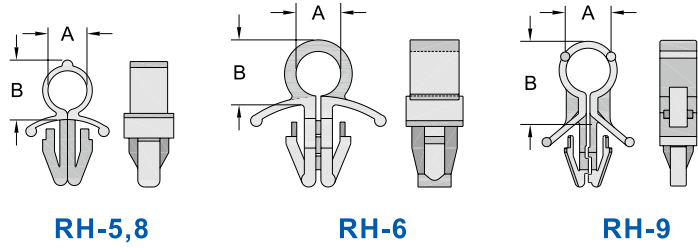

1204 KSS WIRE SADDLE



UNIT : mm



Item No.	Dimension A	PCB		Packing
		hole	thickness	
RWS-6	6.2	6.0	2.0	100 pcs
RWS-7	7.0	7.8	2.0	

- Material: UL approved Nylon 66, 94V-2.
- Color: Natural

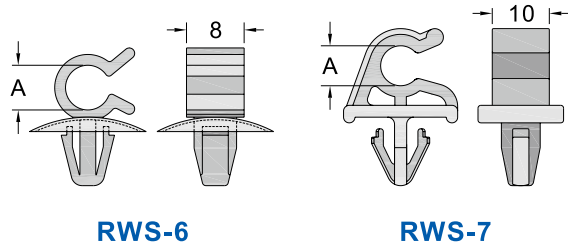

1204 KSS DOUBLE ROUTING CLIP



UNIT : mm



Item No.	Dimension	PCB		Packing
		hole	thickness	
DR-6	As Figure	3.2	2.0	100pcs

- Material: UL approved Nylon 66, 94V-2.
- Color: Natural

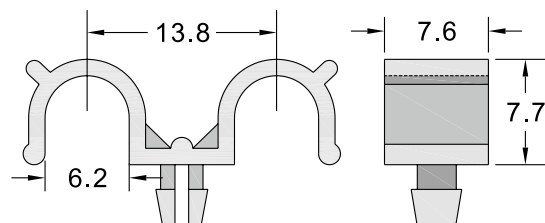

1204 KSS WIRE SADDLE



UNIT : mm



Item No.	Dimension	PCB		Packing
		hole	thickness	
LWS-5	As Figure	4.0	2.4	100pcs

- Material: UL approved Nylon 66, 94V-2.
- Color: Natural

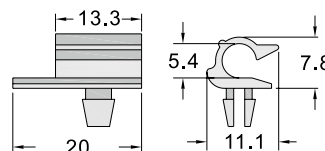

1205 KSS CLIP TWIST TIE



UNIT : mm

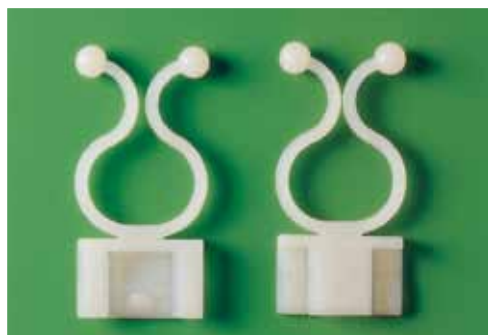

Item No.	Dimension			Packing
	H1	H2	W	
CTT-17	30.5	4.2	16.7	100pcs

- Material: UL approved Nylon 66, 94V-2.
- Color: Natural

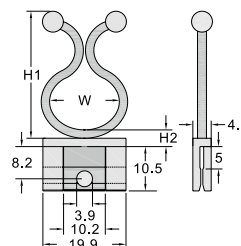

1205 KSS STANDOFF TWIST TIE



UNIT : mm

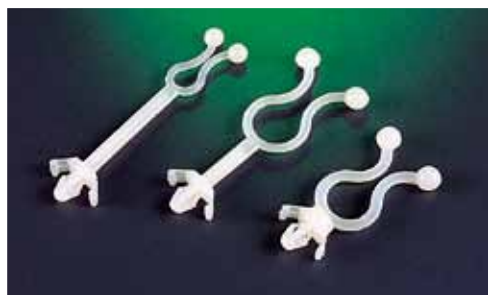

Item No.	Dimension			Mounting Hole	Thickness	Packing
	H1	H2	W			
ST-1	19.5	31.7	6.0	4.6~4.8	1.0~2.8	100 pcs
ST-2	27.8	21.2	11.0	4.8~5.0	1.0~2.8	
ST-3	27.3	4.7	10.4	4.6~4.8	1.0~2.8	
ST-3B	28.0	5.0	11.0	6.2~6.6	0.5~2.0	
ST-3C	32.0	5.0	15.0	4.6~4.8	0.5~1.6	
ST-3D	36.2	5.3	18.0	4.4~4.8	1.0~2.4	
ST-4S	27.9	13.0	11.0	4.2~4.8	1.0~2.4	
ST-4	31.3	13.1	15.0	4.6~4.8	1.0~2.0	
ST-0560	20.5	60.9	5.0	4.6~5.0	1.6~3.0	
ST-0605	19.3	5.3	6.1	4.0~4.4	2.4	
ST-0701	22.0	1.3	7.0	4.6~4.8	1.0~2.8	
ST-1112	26.8	15.3	11.0	4.6~4.8	1.6~3.0	
ST-1247	27.2	50.5	11.0	4.6~4.8	1.6~3.0	
ST-1303	45.0	3.0	13.5	6.6	1.8~3.6	
ST-1602	31.7	5.1	16.0	4.4~4.6	0.5~1.6	
ST-2005	36.5	5.1	20.0	7.2~7.6	1.8~3.6	
ST-2403	44.2	3.2	23.5	4.8~5.0	0.5~2.6	

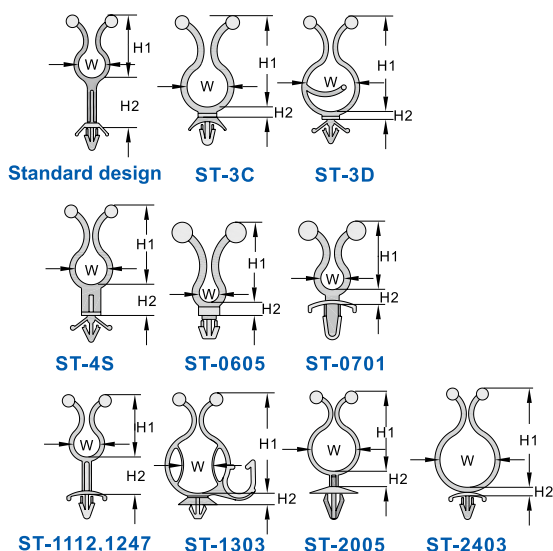

- Material: UL approved Nylon 66, 94V-2
- Color: Natural
- Locking into pre-drilled hole, Insert cables and twist on to fix.

1209 KSS WIRE SADDLE



UNIT : mm



Item No.	Dimension				PCB		Packing
	A	B	C	D	hole	thickness	
RCS-4	4.0	5.0	2.2	2.7	4.0	2.4	100pcs

- Material: UL approved Nylon 66, 94V-2.
- Color: Natural

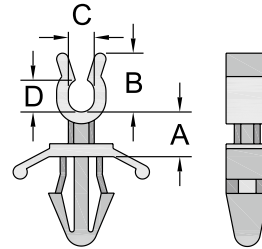

1210 KSS PURSE LOCK TWIST TIE



UNIT : mm



Item No.	Dimension			Packing
	A	B	L	
PL-8	8.0	8.0	18	100pcs
PL-0740	7.5	7.5	40	

- Material: UL approved Nylon 66, 94V-2.
- Color: Black

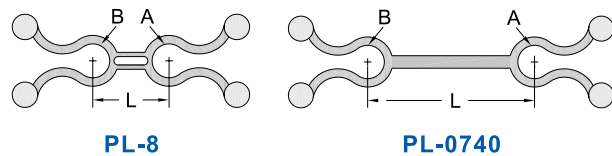

1212 KSS TWIST TIE



UNIT : mm

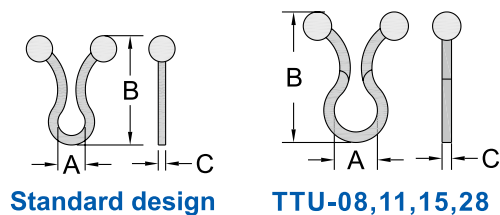
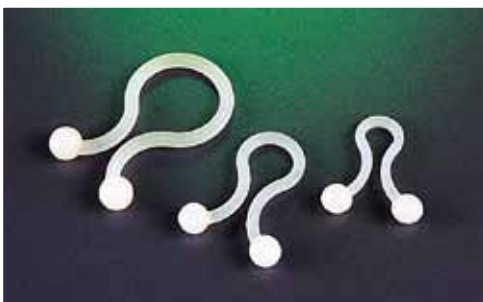

Item No.	Dimension			Bundle Diameter	Packing
	A	B	C		
TT-05	5.1	21.6	1.5	4.4	100 pcs
TT-08	7.0	25.0	2.0	7.0	
TT-11	11.6	29.8	1.7	10.1	
TT-15	15.0	33.8	1.9	13.4	
TT-18	18.6	40.0	1.9	16.2	
TT-24	23.6	45.0	2.0	21.3	
TTU-05	5.0	22.0	1.8	4.2	
TTU-08	8.1	26.2	2.3	7.2	
TTU-11	11.3	29.7	2.3	10.0	
TTU-15	14.8	32.6	2.0	13.2	
TTU-18	18.0	38.0	2.0	16.5	
TTU-22	22.0	42.3	2.0	19.8	
TTU-28	28.0	55.1	2.0	26.7	

- Material: UL approved Nylon 66, 94V-2
- Color: Natural
- Colors available upon request.
- Tie-up cables at economical cost.
- Insert cables and twist on to fix.

1215 KSS MOUNTING TWIST TIE



UNIT : mm



Item No.	A	B	C	Bundle Diameter	Packing
TTB-08	7.9	27.5	17.4	7~10	100 pcs
TTB-15	14.8	35.2	22.0	10~15	
TTB-20	20.6	40.0	25.5	15~20	

- Material: UL approved Nylon 66, 94V-2(Backed with adhesive tape)
- Color: Natural
- Peel off adhesive paper before usage, insert cables and twist on to fix.

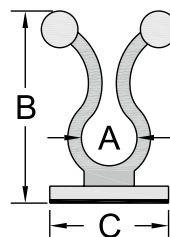

1216 KSS ADHESIVE WIRE SADDLE



UNIT : mm



Item No.	A	B	C	D	Packing
AWS-11	11.2	11.0	20.0	19.8	100pcs
AWS-9R	8.5	13.6	29.8	16.0	
AWS-1210	11.3	10.0	20.7	18.3	
AWS-0912	9.0	11.6	15.8	9.5	

- Material: UL approved Nylon 66, 94V-2 with adhesive tape.
- Color: Natural

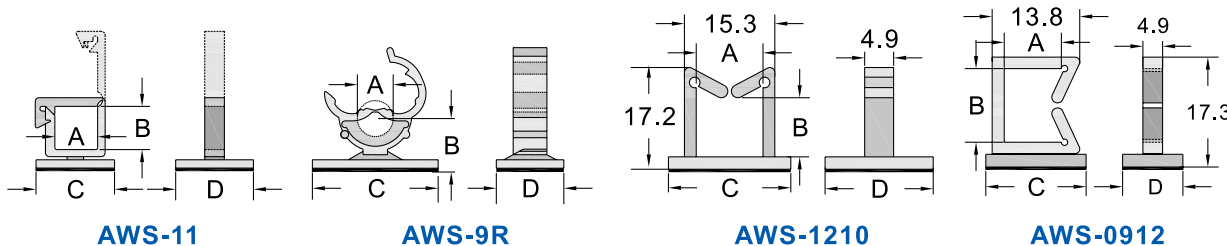

1217 KSS SPACERS RING



UNIT : mm



Item No.	D	H1	H2	Packing
SPR-8V0	28.0	14.2		100pcs
SPR-45V0	49.2	26.3	22	

- Material: UL approved Nylon 66, 94V-0
- Color: White

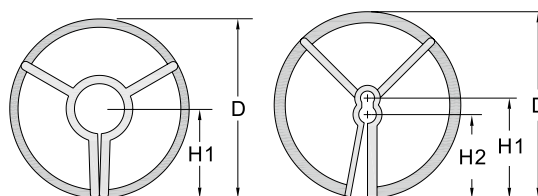

SPR-8V0

SPR-45V0

1301 KSS TRANSISTOR HOUSING



UNIT : mm



Item No.	Dimension	Packing
TH-1V0	As Figure	100pcs

- Material: UL approved Nylon 66, 94V-0
- Color: Black
- To protect transistors from electric short circuit and good for thermal control.

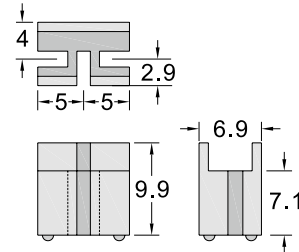

1301 KSS TRANSISTOR HOUSING



UNIT : mm



Item No.	A	B	C	D	Packing
THR-2	5.0	10.1	2.8	4.0	100pcs

- Material: UL approved Nylon 66, 94V-2
- Color: Natural

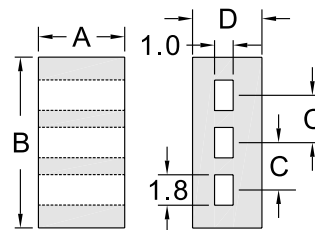

1302 KSS TRANSISTOR COVER



UNIT : mm



Item No.	Dimension	Packing
TH-2V0	As Figure	100pcs
TH-3V0		

- Material: UL approved Nylon 66, 94V-0
- Color: White
- To protect transistor legs from short circuit or breaking.

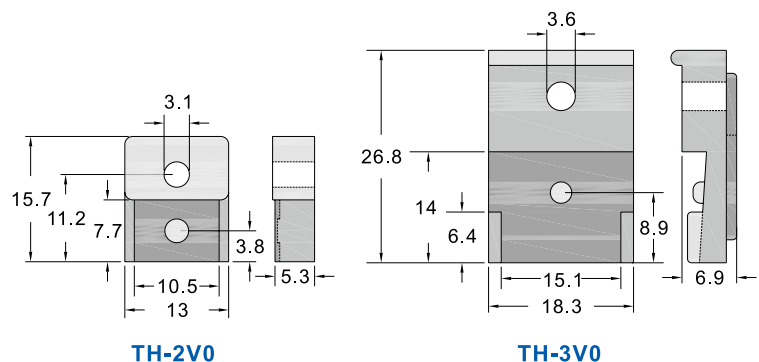

1302 KSS NTC THERMISTOR HOUSING



UNIT : mm

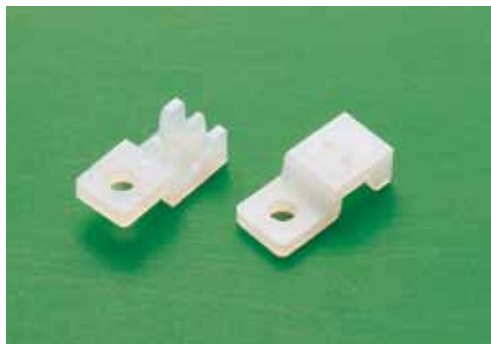

Item No.	A	B	C	Packing
TRH-7V0	16.5	7.5	5.1	100pcs

- Material: UL approved Nylon 66, 94V-0
- Color: White

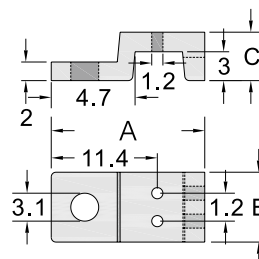

1303 KSS TRANSISTOR HOUSING



UNIT : mm



Item No.	A	B	Packing
TR-3	2.1	1.1	100pcs

- Material: UL approved Nylon 66, 94V-2
- Color: Natural

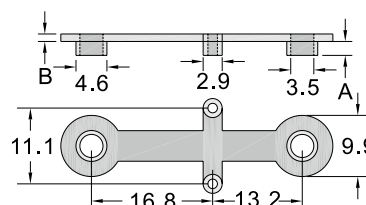

1305 KSS WASHER



UNIT : mm



Item No.	Dimension	Packing
WR-3207	As Figure	100pcs

- Material: UL approved Nylon 66, 94V-2
- Color: Natural

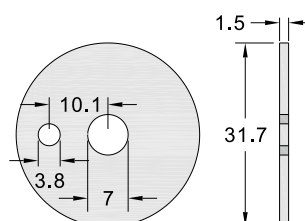

1306 KSS WASHER



UNIT : mm

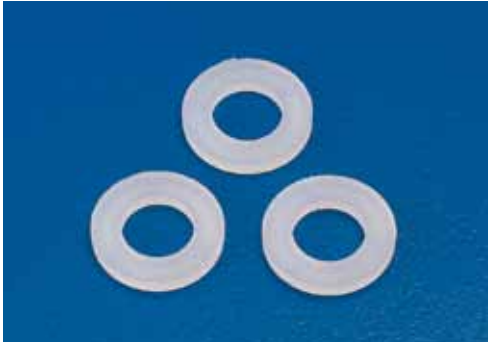

Item No.	A	B	C	Packing
WR-0503	4.5	2.5	0.8	100pcs
WR-0603	6.0	3.0	0.8	
WR-0803	8.0	3.2	1.0	
NEW WR-0904	9.0	4.3	0.8	
NEW WR-1005	10.0	5.3	1.0	
WR-1206	12.0	6.4	1.5	
WR-1208	12.0	8.0	1.5	
※WR-2011RU	20.0	10.6	2.0	

- Material: UL approved Nylon 66, 94V-2
- Color: Natural
- ※ WR-2011RU Material: TPE (Thermoplastic Elastomer) (Black)

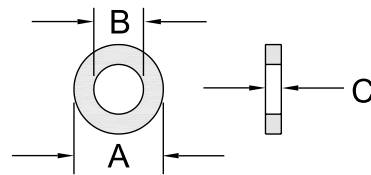

1307 KSS HEADBOARD WASHER



UNIT : mm



Item No.	A	B	C	Packing
HBW-1808	18	8.6	11.7	100pcs

- Material: PE
- Color: Natural

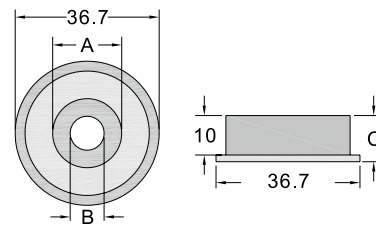

1308 KSS ROUND WASHER



UNIT : mm



Item No.	A	B	C	D	E	Packing
RW-45	4.5	4.0	8.0	6.5	3.1	100pcs

- Material: UL approved Nylon 66, 94V-2
- Color: Natural

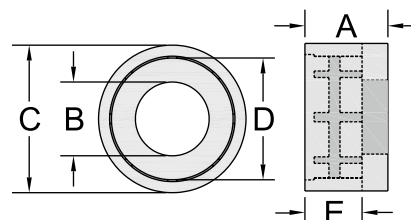

1308 KSS CONOID WASHER



UNIT : mm



Item No.	A	B	C	D	E	Packing
CDW-12	12.2	3.3	6.9	8.3	10.7	100pcs

- Material: UL approved Nylon 66, 94V-2
- Color: Natural

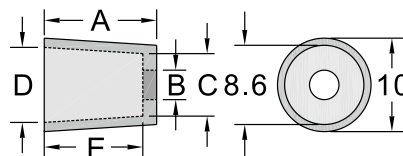

1310 KSS TRANSISTOR WASHER



UNIT : mm

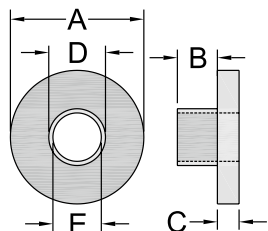

Item No.	A	B	C	D	E	Packing
TW-63A	6.0	8.1	0.5	3.5	2.8	100pcs
TW-63B	6.0	1.4	1.2	3.5	2.9	
TW-63C	6.0	2.3	1.7	3.5	2.9	
TW-63D	6.0	3.2	1.9	3.5	2.9	
TW-63E	6.1	2.6	2.0	3.5	2.9	
TW-63F	6.3	2.0	1.3	3.4	2.9	
TW-73A	6.6	1.8	3.0	4.2	3.2	
TW-73B	6.9	2.5	1.3	3.6	2.9	
TW-83A	7.7	3.7	1.3	5.8	3.1	
TW-83B	7.8	5.6	1.2	3.6	2.9	
TW-83C	7.8	0.9	2.0	4.3	3.2	
TW-83D	8.0	2.3	1.3	3.5	2.9	
TW-83E	7.8	1.2	3.7	5.9	3.2	
TW-123ABK (Black)	12.0	3.0	0.5	5.9	3.2	
TW-133A	12.7	1.7	1.5	7.9	3.7	
TW-163A	16.0	2.0	1.5	6.0	3.2	
TW-189A	18.0	1.5	3.3	12.4	9.3	

- Material: UL approved Nylon 66, 94V-2.
- Color: Natural
- ※ TW-123ABK Black color.

1311 KSS TRANSISTOR WASHER



UNIT : mm



Item No.	A	B	Packing
TRW-3	5.7	3.0	100pcs
TRW-5	8.9	4.6	

- Material: UL approved Nylon 66, 94V-2
- Color: Natural

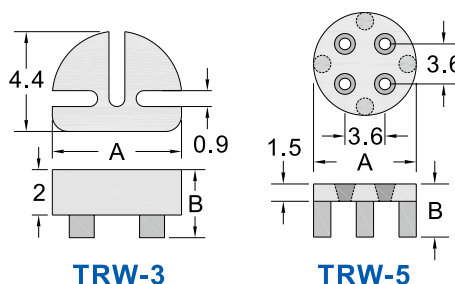

TRW-3

TRW-5



1321 KSS LED HOLDER

UNIT : mm

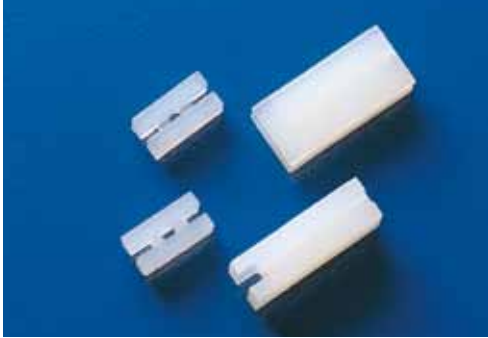

Item No.	Dimension						Packing
	A	B	C	D	E	F	
LE-3	3.1	3.6	1.0	1.2	7.2	3.6	100pcs
LE-6	6.0	3.6	1.0	1.2	7.1	3.9	
LE-13	12.9	4.0	1.0	1.4	6.0	3.9	

- Material: UL approved Nylon 66, 94V-2
- Color: Natural

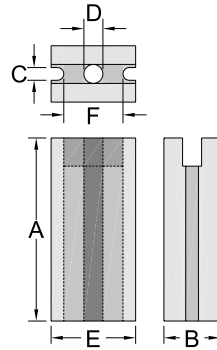

1322 KSS LED HOLDER



UNIT : mm



Item No.	Dimension A	Packing
LK-5	5	100pcs
LK-18	18	

- Material: UL approved Nylon 66, 94V-2
- Color: Natural

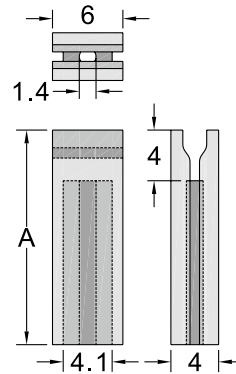

1327 KSS LED HOLDER



UNIT : mm

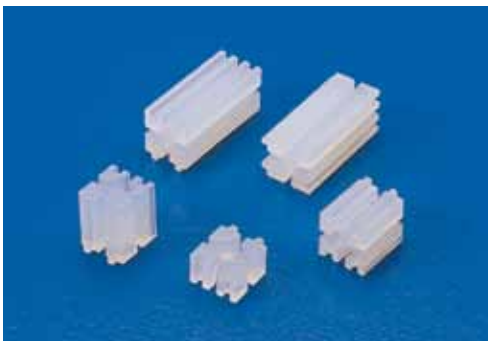

Item No.	Dimension		Packing
	A	B	
LX-3	3	5	100pcs
LX-6	6	5	
LX-12	12	5	

- Material: UL approved Nylon 66, 94V-2
- Color: Natural

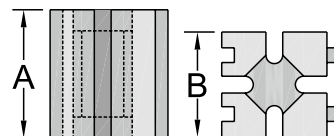

1328 KSS LED HOLDER



UNIT : mm



Item No.	Dimension		Packing
	A	B	
LQT-3	3.1	6.6	100pcs

- Material: UL approved Nylon 66, 94V-2
- Color: Natural

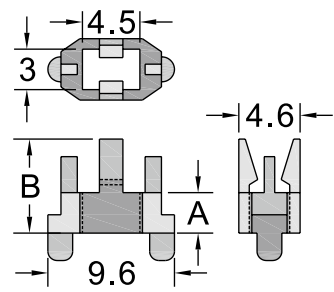

1329 KSS LED HOLDER



UNIT : mm



Item No.	Dimension	Packing
	A	
LQ-2	2.6	100pcs

- Material: UL approved Nylon 66, 94V-2
- Color: Natural

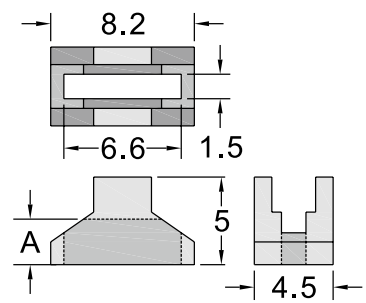

1331 KSS LED HOLDER



UNIT : mm



Item No.	Dimension			Packing
	A	B	C	
LDT-17	17.2	4.7	5.7	100pcs

- Material: UL approved Nylon 66, 94V-2
- Color: Natural

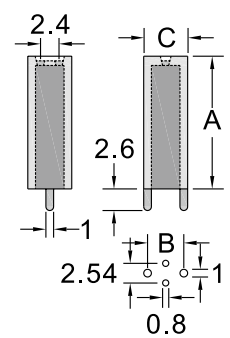

To fit hole

1332 KSS LED HOLDER



UNIT : mm



Item No.	Dimension		Packing
	A	LED	
LD3-6	6.1	3Ø2PIN	100pcs
LD3-9	9.0		
LD3-12	12.0		
LD3-16	16.0		
LD3-19	19.0		

- Material: UL approved Nylon 66, 94V-2
- Color: Natural

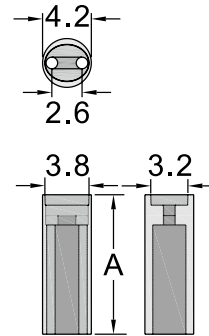

1333 KSS LED HOLDER



UNIT : mm



Item No.	Dimension A	Packing
LY-14	14.1	100pcs

- Material: UL approved Nylon 66, 94V-2
- Color: Natural

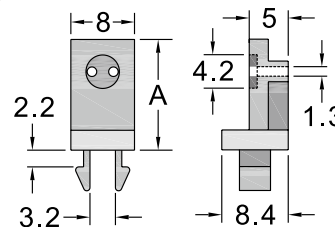

1334 KSS LED HOLDER



UNIT : mm

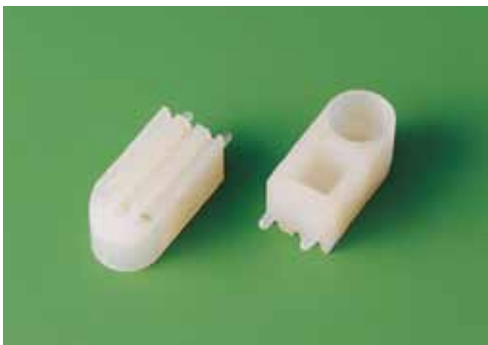

Item No.	Dimension						Packing
	A	L	L1	W	H	LED	
LG3-12	12.0	7.1	3.6	7.5	15.8	5Ø3PIN	100pcs
LG3-18	17.5	7.1	3.7	7.5	21.6	5Ø3PIN	

- Material: UL approved Nylon 66, 94V-2
- Color: Natural

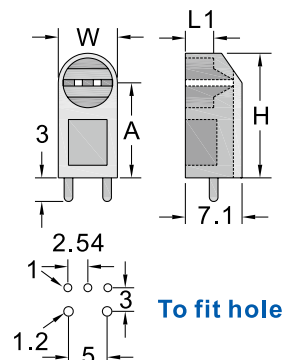

1335 KSS LED HOLDER



UNIT : mm

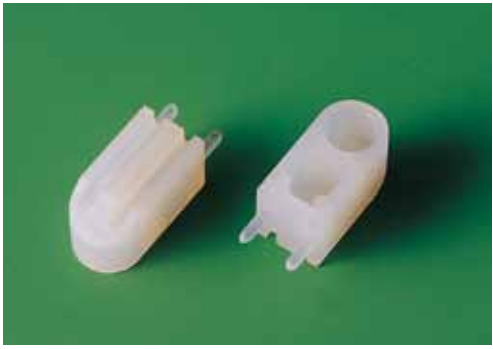

Item No.	Dimension						Packing
	A	L	L1	W	H	LED	
LG-8	7.8	5.6	3.1	5.5	10.8	3Ø2PIN	100pcs

- Material: UL approved Nylon 66, 94V-2
- Color: Natural

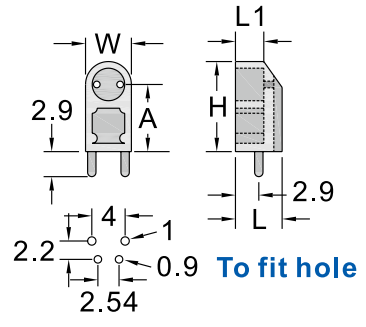

1336 KSS LED HOLDER



UNIT : mm



Item No.	Dimension					Packing
	A	L	W	H	LED	
LH-4	4.5	5.6	5.4	7.2	5Ø2PIN	100pcs

- Material: UL approved Nylon 66, 94V-2
- Color: Natural

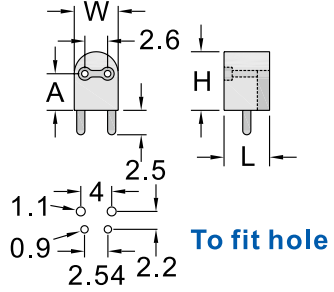

1337 KSS LED HOLDER



UNIT : mm



Item No.	Dimension					Packing
	A	L	W	H	LED	
LHN-10	10	5.6	5.5	12.8	5Ø2PIN	100pcs

- Material: UL approved Nylon 66, 94V-2
- Color: Natural

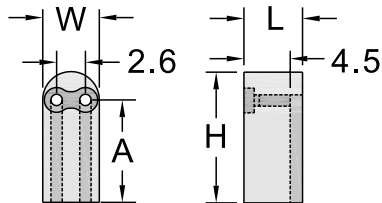

1338 KSS LED HOLDER



UNIT : mm



Item No.	Dimension						Packing
	A	L	L1	W	H	LED	
PLU-9	9	10.2	3.5	8	13.1	5Ø3PIN	100pcs

- Material: UL approved Nylon 66, 94V-2
- Color: Natural

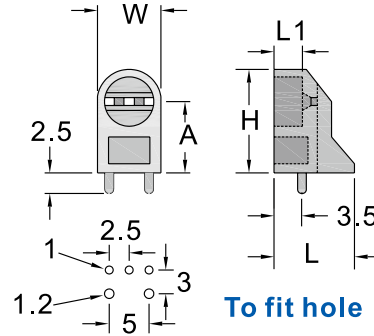

1339 KSS LED HOLDER



UNIT : mm



Item No.	Dimension						Packing
	A	L	L1	W	H	LED	
LHK-3	2.7	6	1	7.6	6	5Ø3PIN	100pcs

- Material: UL approved Nylon 66, 94V-2
- Color: Natural

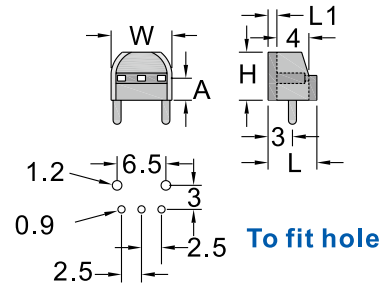

1341 KSS LED HOLDER



UNIT : mm



Item No.	Dimension						Packing
	A	L	L1	W	H	LED	
PLK-5	4.7	8.2	6	7.6	9	5Ø3PIN	100pcs

- Material: UL approved Nylon 66, 94V-2
- Color: Natural

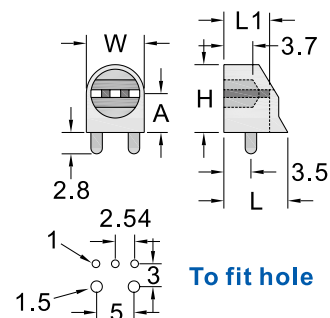

1343 KSS LED HOLDER



UNIT : mm



Item No.	Dimension						Packing
	A	L	L1	W	H	LED	
PLM-16	16	6.7	3.4	5.1	18.7	3Ø2PIN	100pcs

- Material: UL approved Nylon 66, 94V-2
- Color: Natural

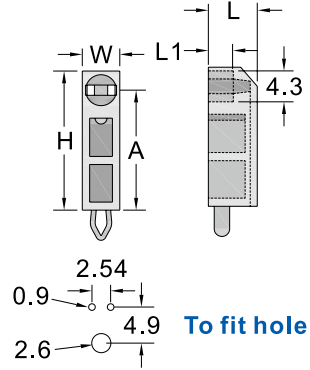

1344 KSS LED HOLDER



UNIT : mm



Item No.	Dimension					Packing
	A	L	W	H	LED	
PLX-18	18.2	7.7	9.6	21.6	5Ø2PIN	100pcs
PLW-18	18.2	9.7	9.0	21.6	5Ø3PIN	

- Material: UL approved Nylon 66, 94V-2
- Color: Natural

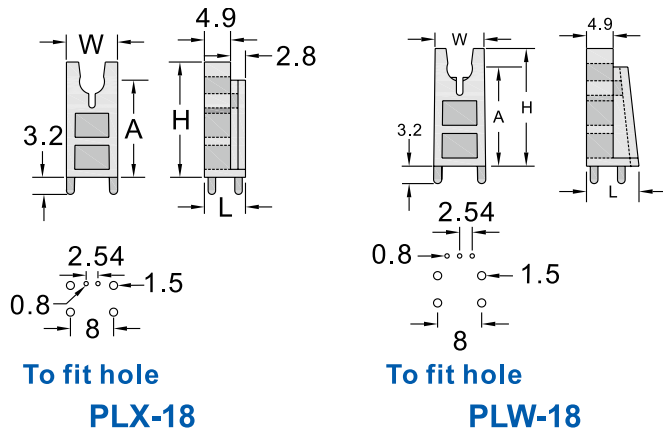

1345 KSS LED HOLDER



UNIT : mm



Item No.	Dimension									Packing
	A	A1	L	L1	W	H	P1	P2	LED	
PLD1-3A	5.05		6.5	2.0	4.7	7.5	4.65		3Ø2PIN	100pcs
PLD2-3A	2.8	5.0	9.2	2.8	4.5	10.0	4.9	7.2	3Ø2PIN	
PLD2-3B	2.6	5.0	8.2	2.6	4.8	9.9	4.8	7.2	3Ø2PIN	
PLD2-5C	2.95	6.3	11.2	4.5	5.9	12.2	5.6	7.7	5Ø2PIN	
PLD4-3A	2.6	5.0	10.2	1.0	10.2	10.2	6.4	9.2	3Ø2PIN	
PLD4-3B	5.6		20.4	4.4	22.7	9.0	15.0		3Ø2PIN	

- Material: UL approved Nylon 66, 94V-2
- Color: Black

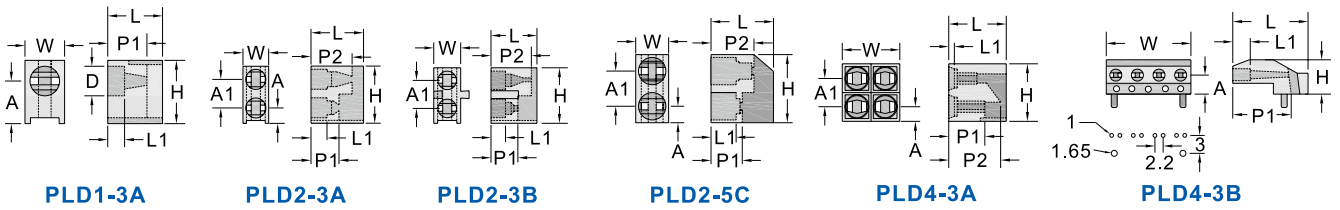

1346 KSS LED HOLDER



UNIT : mm



Item No.	Dimension						Packing
	A	L	W	H	P1	LED	
PLT-4	3.7	6.7	6.7	7.0	3.1	5Ø2PIN	100pcs

- Material: UL approved Nylon 66, 94V-2
- Color: Natural

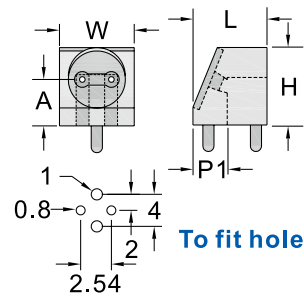

1347 KSS LED HOLDER



UNIT : mm

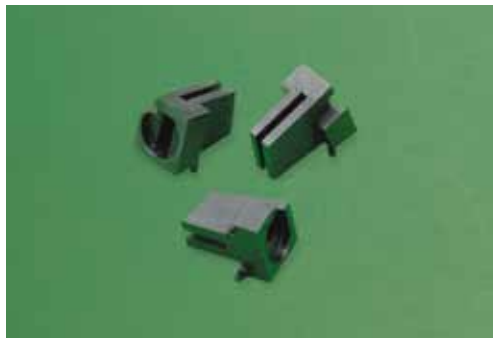

Item No.	Dimension								Packing
	A	L	L1	W	H	P1	P2	LED	
PLR-4	4	11	1.2	7.7	8	5.8	8	5Ø3PIN	100pcs

- Material: UL approved Nylon 66, 94V-2
- Color: Black

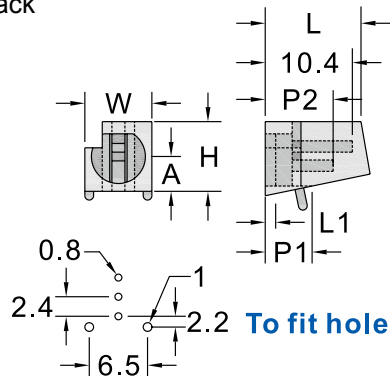

1349 KSS LED HOLDER



UNIT : mm



Item No.	Dimension						Packing
	L	L1	D1	D2	T	LED	
PCL-5A	7.2	4.5	6.2	7.8	1.5	Ø5	100pcs
PCL-3H	5.2	3.2	4.8	5.5	1.2	Ø3	

- Material: UL approved Nylon 66, 94V-2
- Color: Black

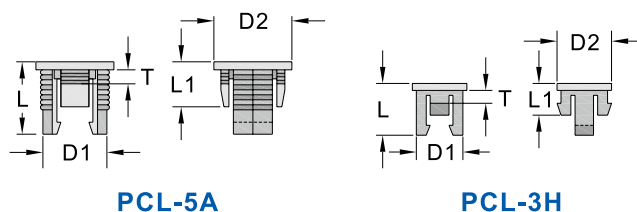

1351 KSS CAPACITOR HOUSING



UNIT : mm



Item No.	Dimension			Packing
	A	B	C	
CAP-10	12.5	10.4	9.5	100pcs

- Material: UL approved Nylon 66, 94V-2
- Color: Natural

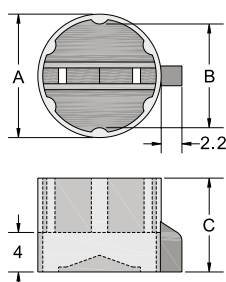

1401 KSS PLASTIC SCREWS



UNIT : mm

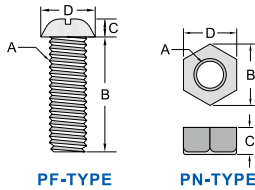

	Item No.		A	B	C	D	Packing	
	PC	NYLON						
SCREW 		PF-205NK	M2x0.4	5.0	1.6	4.5	1000pcs	
		PF-208NK		8.0				
		PF-210NK		10.0				
		PF-306K	PF-306NK	M3x0.5	6.0	2.5		5.25
		PF-308K	PF-308NK		8.0			
		PF-310K	PF-310NK		10.0			
		PF-312K	PF-312NK		12.0			
		PF-408K	PF-408NK	M4x0.7	8.0	2.6		7.5
		PF-410K	PF-410NK		10.0			
		PF-412K	PF-412NK		12.0			
		PF-414K	PF-414NK		14.0			
		PF-420K	PF-420NK		20.0			
		PF-425K	PF-425NK		25.0			
		PF-520K	PF-520NK		20.0			
		PF-530K	PF-530NK	M5x0.8	30.0	3.5		8.7
		PF-540K	PF-540NK		40.0			
		PF-620K	PF-620NK	M6x1.0	20.0	4.0		10.0
		PF-630K	PF-630NK		30.0			
	PF-640K	PF-640NK	40.0					
NUT 	-	PN-2NK	M2x0.4	4.5	1.5	4.0		
		PN-3K	PN-3NK	M3x0.5	6.4	2.7	5.6	
		PN-4K	PN-4NK	M4x0.7	8.1	3.2	7.0	
		PN-5K	PN-5NK	M5x0.8	9.2	4.0	8.0	
		PN-6K	PN-6NK	M6x1.0	11.5	5.0	10.0	

- Material: PC (POLYCARBONATE) -Transparent or Nylon 66.
- For better insulation, light weight, no rust.
- Used extensively as metal screw but where insulation is needed. Good for computer or electronics equipment fixation.
- For Nylon 66, Add "N" to Item No.

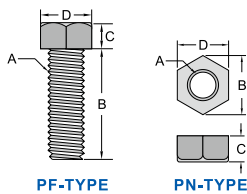

	Item No.	A	B	C	D	Packing
SCREW 	PF-820N	M8x1.25	20	5.4	12.8	NYLON 100 pcs
	PF-830N		30			
	PF-840N		40			
	PF-1030SN	M10x1.5	30	5.5	13.6	
	PF-1030N		30		16.6	
	PF-1040SN		40		13.6	
	PF-1040N		40		16.6	
NUT 	PN-8N	M8x1.25	14.5	6.4	12.8	
	PN-10N	M10x1.5	19.2	8.0	16.7	

- Material: Nylon 66, 94V-2
- Color: Natural
- For better insulation, light weight, no rust.
- Used extensively as metal screw but where insulation is needed. Good for computer or electronics equipment fixation.

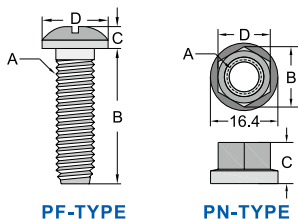

	Item No.	Color	A	B	C	D	Packing
SCREW 	NEW PF-823HN	Natural	M8x1.25	22.5	5.5	15.8	NYLON 100 pcs
	PF-823HNGYJ	Grey					
NUT 	NEW PN-8HN	Natural	M8x1.25	14.6	10	12.8	
	PN-8HNGYJ	Grey					

- Material: Nylon 66, 94V-2

2001 KSS RJ45 MODULAR PLUG & PLUG COVER



UNIT : mm



Modular Plug

Item No.	Description	Packing
RJ45-8A2	Design for Cat5 , Cat5e Modular Plug (Stranded Wire)	100pcs
RJ45-8A3	Design for Cat5 , Cat5e Modular Plug (Stranded Wire or Solid Wire)	
RJ45-8C6	Design for Cat6 Modular Plug (Stranded Wire or Solid Wire)	
NEW RJ45-8C6A	Design for Cat6 Modular Plug, shield protected (Stranded Wire or Solid Wire)	

- Design for Cat5 , Cat5e , Cat6 cables standard, gilded design for better connection.

Modular Plug Cover

Item No.	Color	Packing
RJ45-60GN	Green Plug Cover	100pcs
RJ45-60GY	Gray Plug Cover	
RJ45-60RD	Red Plug Cover	
RJ45-60YW	Yellow Plug Cover	
RJ45-60BE	Blue Plug Cover	
RJ45-60BK	Black Plug Cover	

- Design for Cat5 , Cat5e , Cat6 cables plug cover, to prevent dust.

2002 KSS DUST COVER FOR RJ45 PLUG



UNIT : mm

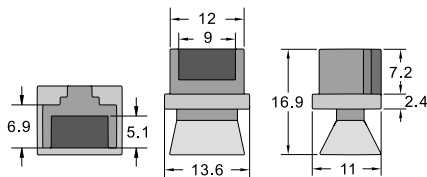

Item No.	Dimension	Packing
RJ45-DC1	As Figure	100pcs

- Material: Soft PVC
- Color: Black, available in natural or other colors.
- Function: Dust cover for RJ45 plug.

2005 U CONNECTOR



UNIT : mm



Item No.	Maximum Resist Size mm	Wire dia. AWG	Packing
UY	1.52	22~26	100pcs
NEW UY2	2.08	19~26	

- Specialty: Conduct the circuit without peeling the wire ; also achieve at least UL Category 5's transmission result.

1501 KSS TERMINAL & TOOL



RING TERMINAL



INSULATED RING TERMINAL



BUTT SPLICE(INSULATED)



CRIMPER



RING TERMINAL



Y INSULATED TERMINAL



NYLON CINSULATED BUTT SPLICE



CRIMPER



Y TERMINAL



PIN INSULATED TERMINAL



FEMALE LUG



WIRE STRIPPER



PIN TERMINAL



BULLET SOCKET



MALE LUG



WIRE STRIPPER



CABLE LUG



BULLET TERMINAL



NYLON INSULATED FEMALE LUG



CRIMPER



BUTT SPLICE



PIGGY BACK DISCONNECT



NYLON INSULATED MALE LUG



CRIMPER



PARALLEL SPLICE



INSULATED FEMALE LUG



CORD END TERMINAL



CRIMPING TOOL



KSS VALUE PACK



※ AVAILABLE IN DIFFERENT QUANTITY / SIZE / COLOR

KSS CABLE TIES



BP-650

CONTENTS:
CV-100 100pcs Natural
CV-100 200pcs Colored (RD, YW, BE, GN)@50pcs
CV-200 300pcs Natural
CV-280 50pcs Natural

BP-1001

CONTENTS:
CV-100
 361pcs Natural
CV-100
 150pcs Colored (RD, YW, BE)@50pcs
CV-200
 425pcs Natural
CV-280
 65pcs Natural

BP-1000

CONTENTS:
CV-100
 200pcs Natural
CV-100
 400pcs Colored (RD, YW, BE, GN)@100pcs
CV-200
 350pcs Natural
CV-280
 50pcs Natural

BP-850

CONTENTS:
CV-100
 100pcs Natural
CV-100
 400pcs Colored (RD, YW, BE, GN)@100pcs
CV-200
 300pcs Natural
CV-280
 50pcs Natural

BP-1200

CONTENTS:
CV-100
 200pcs Natural
CV-100 500pcs (BK)@200pcs
 (RD, YW, GN)@100pcs
CV-200
 400pcs Natural
CV-280
 100pcs Natural



CP-300

CONTENTS:
CV-100
 100pcs Natural
CV-100
 100pcs Colored (RD, YW, BE, GN)@25pcs
CV-200S
 50pcs Colored (RD, BE)@25pcs
CV-200S
 50pcs Natural

CP-400

CONTENTS:
CV-100
 300pcs Colored (RD, BE, GN)@100pcs
CV-200S
 100pcs Natural
CPH-1000
CONTENTS:
CV-100
 1000pcs Colored



DB-75BK

CONTENTS:
CV-094BK 25pcs Black
CV-120LBK 25pcs Black
CV-190BK 25pcs Black

DB-75

CONTENTS:
CV-094 25pcs Natural
CV-120L 25pcs Natural
CV-190 25pcs Natural

DB-75C

CONTENTS:
CV-094 25pcs Natural
CV-120LRD 25pcs Red
CV-190YW 25pcs Yellow

VP-75-3C

(3 Compartment Pack)
CONTENTS:
CV-100
 25pcs Natural
CV-140
 25pcs Natural
CV-200A
 25pcs Natural

※COLORS AVAILABLE

KSS CABLE TIES



- VP-50-4BK**
CONTENTS: CV-100BK 50pcs Black
- VP-50-4NA**
CONTENTS: CV-100 50pcs Natural
- VP-50-8BK**
CONTENTS: CV-200SBK 50pcs Black
- VP-50-11NA**
CONTENTS: CV-280 50pcs Natural
- VP-50-11BK**
CONTENTS: CV-280BK 50pcs Black



- VP-50-48C**
CONTENTS:
CV-100 25pcs Black(6), Red(7), Yellow(6), Blue(6)
CV-200S 25pcs Black(6), Red(7), Yellow(6), Blue(6)

- VP-50-48YW**
CONTENTS: CV-100YW 25pcs Yellow
CV-200SYW 25pcs Yellow

- VP-50-48BK**
CONTENTS: CV-100BK 25pcs Black
CV-200SBK 25pcs Black

- VP-50-48RD**
CONTENTS: CV-100RD 25pcs Red
CV-200SRD 25pcs Red

- VP-50-48NA**
CONTENTS: CV-100 25pcs Natural
CV-200S 25pcs Natural



- VP-50-811YW**
CONTENTS: CV-200SYW 25pcs Yellow
CV-280YW 25pcs Yellow

- VP-50-811RD**
CONTENTS: CV-200SRD 25pcs Red
CV-280RD 25pcs Red

- VP-50-811BE**
CONTENTS: CV-200SBE 25pcs Blue
CV-280BE 25pcs Blue

- VP-50-811NA**
CONTENTS: CV-200S 25pcs Natural
CV-280 25pcs Natural

- VP-50-811BK**
CONTENTS: CV-200SBK 25pcs Black
CV-280BK 25pcs Black



- PB-100-5NA**
CONTENTS: CV-120S 100pcs Natural
- PB-100-6.5NA**
CONTENTS: CV-165 100pcs Natural
- PB-100-8NA**
CONTENTS: CV-200A 100pcs Natural
- PB-100-10NA**
CONTENTS: CV-250 100pcs Natural

※ COLORS AVAILABLE

KSS CABLE TIES



VP-50-4811C

CONTENTS:
 CV-100 20pcs Red(5), Blue(5), Yellow(5), Black(5)
 CV-200S 20pcs Red(5), Blue(5), Yellow(5), Black(5)
 CV-280 10pcs Red(2), Blue(3), Yellow(2), Black(3)

VP-50-811C

CONTENTS:
 CV-200S 25pcs Red(7), Blue(6), Yellow(6), Black(6)
 CV-280 25pcs Red(7), Blue(6), Yellow(6), Black(6)

VP-150-4811C

CONTENTS:
 CV-100 50pcs Red(10), Blue(10), Yellow(10), Black(10), Natural(10)
 CV-200S 50pcs Red(10), Blue(10), Yellow(10), Black(10), Natural(10)
 CV-280 50pcs Red(10), Blue(10), Yellow(10), Black(10), Natural(10)



PB-100-4NA

CONTENTS: CV-100 100pcs Natural

PB-100-4BK

CONTENTS: CV-100BK 100pcs Black

PB-100-4YW

CONTENTS: CV-100YW 100pcs Yellow

PB-100-4RD

CONTENTS: CV-100RD 100pcs Red

PB-100-4BE

CONTENTS: CV-100BE 100pcs Blue

PB-100-4GN

CONTENTS: CV-100GN 100pcs Green



PB-100-4C

CONTENTS:
 CV-100YW 50pcs Yellow CV-100RD 50pcs Red

CONTENTS:
 CV-100GN 50pcs Green CV-100RD 50pcs Red

CONTENTS:
 CV-100RD 50pcs Red CV-100BK 50pcs Black

CONTENTS:
 CV-100GN 50pcs Green CV-100BK 50pcs Black

CONTENTS:
 CV-100YW 50pcs Yellow CV-100BK 50pcs Black



DB-350

CONTENTS:
 CV-100 100pcs Natural
 CV-100C 100pcs Colored (RD, BE, YW, BK)@25pcs
 CV-200S 50pcs Natural
 CV-200SC 50pcs Colored (YW, BK)@13pcs (RD, BE)@12pcs
 CV-280C 50pcs Colored (YW, BK)@13pcs (RD, BE)@12pcs

KSS CABLE TIES



EP-400

CONTENTS:

- CV-100 200pcs
(Neon PK, OE, GN, YW)@50pcs
- CV-150 100pcs
(Neon PK, OE, GN, YW)@25pcs
- CV-200 100pcs
(Neon PK, OE, GN, YW)@25pcs



EP-510

CONTENTS:

- CV-100 200pcs
(Colored RD, BE, YW, GN) @50pcs
- CV-200 100pcs
(Colored Natural, Black) @50pcs
- CV-200S 200pcs
(Colored RD, BE, YW, GN) @50pcs
- MGT240C 10pcs
(Colored RD, BE, YW, GN, BK) @2pcs



QP-500

CONTENTS:

- CV-100 100pcs Natural
- CV-100C 100pcs Colored
(RD, BE, YW, BK)@25pcs
- CV-140 100pcs Natural
- CV-140BK 100pcs Black
- CV-180 50pcs Natural
- CV-180BK 50pcs Black



NEW

PHB-200BK-10

CONTENTS:

- HB-200BK @10pcs Black



※ AVAILABLE IN DIFFERENT QUANTITY / SIZE / COLOR

KSS CABLE TIES



PVF150C-20

CONTENTS:
 Clover @2pcs **Neon Green**
 Apple @2pcs **Neon Green**
 Heart @2pcs **Pink**
 Ribbon @2pcs **Pink**
 Butterfly @2pcs **Yellow**
 Star @2pcs **Yellow**
 Flower @2pcs **Neon Orange**
 Giraffe @2pcs **Neon Orange**
 Rabbit @2pcs **Blue**
 Elephant @2pcs **Blue**



PVA150C-20

CONTENTS:
 Butterfly @5pcs **Pink**
 Giraffe @5pcs **Neon Orange**
 Rabbit @5pcs **Neon Green**
 Elephant @5pcs **Blue**

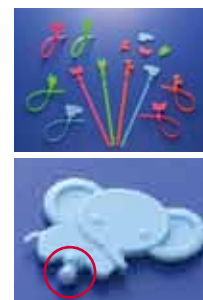

DP-2-A05NYW

CONTENTS: Star @2pcs **Yellow**

DP-2-A11NOE

CONTENTS: Ribbon @2pcs **Orange**

DP-2-A02NGN3

CONTENTS: Clover @2pcs **Green**

DP-2-A06PK

CONTENTS: Flower @2pcs **Pink**



DP-2-DE1NGN3

CONTENTS:
 Taiwan @2pcs **Green**



※ **AVAILABLE IN DIFFERENT QUANTITY / SIZE / COLOR**

KSS CABLE CLIPS



PB-10-NF

CONTENTS:
NF-0.7 10Pcs White



DB-25-NF2.6S

CONTENTS:
NF-2.6S 25pcs White



DB-47

CONTENTS:
DNF-13 7pcs White
NC-1.5NBK 20pcs Black
US-13 20pcs



QPH-500-28S

CONTENTS:
NF-2.8S
500pcs / Bucket White



DB-25

CONTENTS:
NT-1 5pcs
NC-0.5N 10pcs
NC-1.5N 5pcs
NC-3N 5pcs

DB-100

CONTENTS:
CV-075 30pcs
CV-100 20pcs
KW-1 10pcs
CE-2 9pcs
CE-5 9pcs
UC-0.5 6pcs
UC-1 8pcs
UC-2 8pcs



SMALL BOX

SNC-0.4N
CONTENTS: NC-0.4N 100pcs White

SNC-0.5N
CONTENTS: NC-0.5N 100pcs White

SNC-1N
CONTENTS: NC-1N 100pcs White

MEDIUM BOX

MNC-1.5N
CONTENTS: NC-1.5N 100pcs White

MNC-2N
CONTENTS: NC-2N 100pcs White

MNC-2.5N
CONTENTS: NC-2.5N 100pcs White

LARGE BOX

LNC-3N
CONTENTS: NC-3N 100pcs White

LNC-3.5N
CONTENTS: NC-3.5N 100pcs White

LNC-4N
CONTENTS: NC-4N 100pcs White

※ AVAILABLE IN DIFFERENT QUANTITY / SIZE / COLOR

KSS CABLE CLIPS



QB-500

CONTENTS:

NC-0810 500pcs White

QB-800

CONTENTS:

NC-0.4N 300pcs Grey

NC-0.5N 300pcs Grey

NF-2.0 100pcs White

NF-2.2 100pcs White

QB-850

CONTENTS:

NC-0.4N 300pcs Grey

NC-1.5N 150pcs Grey

NC-2.5N 100pcs Grey

NF-1.2BK 300pcs Black

QBS-400

CONTENTS:

NC-1NWE 100pcs White

NC-1.5NWE 100pcs White

NC-2NWE 100pcs White

NC-2.5NWE 100pcs White

QB-1200

CONTENTS:

NC-0.5N 1200pcs Grey

※ AVAILABLE IN DIFFERENT QUANTITY / SIZE / COLOR



CABLE CLIPS ALSO AVAILABLE IN 4 COMPARTMENT SQUARE CANISTER PACKING

● ROUND CLIPS

Item No.	W (mm)	Packing
PNC-0.35N	3.5	100 pcs/box
PNC-0.4N	4	
PNC-0.5N	5	
PNC-1N	6	
PNC-1.5N	7	
PNC-2N	8	
PNC-2.5N	9	
PNC-3N	10	
PNC-3.5N	11	
PNC-4N	12	
PNC-6N	14	
PNC-7N	16	
PNC-7.5N	20	
PNC-8N	22	50 pcs/box
PNC-9N	25	
PNC-10N	32	

● FLAT CLIPS

Item No.	W (mm)	Packing
PNF-0.7	5.5	100 pcs/box
PNF-1.2	6.2	
PNF-1.6	8.0	
PNF-2.0	8.5	
PNF-2.2	10.0	
PNF-2.6	13.5	
PNF-2.6S	13.5	
PNF-2.8	15	
PNF-2.8S	15	
PNF-3.0	18	
PNF-3.2	19	

KSS CABLE MARKER , SCREW ON WIRE CONNECTORS



PB-SM0C-09

CONTENTS:

SM-0 0 ~ 9 250pcs

(Colored BK, BN6, RD, OE, YW2, GN , BEC, VT, GY, WE) @25 pcs

PB-SM0YW-AM

CONTENTS:

SM-0 A ~ M 325pcs YW @25 pcs

PB-SM0YW-NZ

CONTENTS:

SM-0 N ~ Z 325pcs YW @25 pcs



PB-SM1C-09

CONTENTS:

SM-1 0 ~ 9 150pcs

(Colored BK, BN6, RD, OE, YW2, GN , BEC, VT, GY, WE) @15 pcs

PB-SM1YW-AM

CONTENTS:

SM-1 A ~ M 195pcs YW @15 pcs

PB-SM1YW-NZ

CONTENTS:

SM-1 N ~ Z 195pcs YW @15 pcs

PB-SM2C-09

CONTENTS:

SM-2 0 ~ 9 150pcs

(Colored BK, BN6, RD, OE, YW2, GN , BEC, VT, GY, WE) @15 pcs

PB-SM2YW-AM

CONTENTS:

SM-2 A ~ M 195pcs YW @15 pcs

PB-SM2YW-NZ

CONTENTS:

SM-2 N ~ Z 195pcs YW @15 pcs

PB-SM3C-09

CONTENTS:

SM-3 0 ~ 9 100pcs

(Colored BK, BN6, RD, OE, YW2, GN , BEC, VT, GY, WE) @10 pcs

PB-SM3YW-AM

CONTENTS:

SM-3 A ~ M 130pcs YW @10 pcs

PB-SM3YW-NZ

CONTENTS:

SM-3 N ~ Z 130pcs YW @10 pcs



DB-25-SW

CONTENTS:

SW-73BH 10pcs Orange

SW-74BH 10pcs Yellow

SW-76BH 5pcs Red



DB-25-73B

CONTENTS:

SW-73BH 25pcs Orange



DB-20-74B

CONTENTS:

SW-74BH 20pcs Yellow

KSS SCREW ON WIRE CONNECTORS , CORD END TERMINALS



QP-115-SW

CONTENTS:
 SW-71BH 25pcs Grey
 SW-72BH 25pcs Blue
 SW-73BH 20pcs Orange
 SW-74BH 20pcs Yellow
 SW-76BH 25pcs Red

QP-80-SW

CONTENTS:
 SW-72BH 25pcs Blue
 SW-73BH 25pcs Orange
 SW-74BH 30pcs Yellow

QP-50-SW

CONTENTS:
 SW-73BH 50pcs Orange

QP-40-SW

CONTENTS:
 SW-73BH 20pcs Orange
 SW-74BH 20pcs Yellow



DB-50-RF5-8

CONTENTS:
 RF5.5-8 50pcs Yellow

DB-25-RF2-4

CONTENTS:
 RF2-4 25pcs Blue

DB-10-YF1-4

CONTENTS:
 YF1.25-4 10pcs Red



DB-40

CONTENTS:
 YF1.25-3S 5pcs Red
 YF5.5-5 3pcs Yellow
 RF1.25-4 3pcs Red
 RF2-5 7pcs Blue
 BF-1.25S 5pcs Red
 BF-2.0S 4pcs Blue
 BF-5.5S 3pcs Yellow
 LV1.25-5A 5pcs Red
 LV2-5A 5pcs Blue



ET-075-500

CONTENTS:
 ET0.75-8 White 500pcs/bag+Header

ET-35-50

CONTENTS:
 ET35-25 Red 50pcs/bag+Header

KSS CORD END TERMINALS , CABLE CLAMPS , FASTENERS , HEAT-SHRINKABLE TUBINGS



VS-24-HC100C

CONTENTS:

- HC-100-S4 12pcs Natural
- HC-100BK-S4 12pcs Black



PB-12FC3BK

CONTENTS:

- FC-3BK 12pcs Black



PB-5-AP

CONTENTS:

- AP-1720NA 5pcs Natural



PB-30TT11GN

CONTENTS:

- TT-11GN 30pcs Green

PB-20TT18YW

CONTENTS:

- TT-18YW 20pcs Yellow

PB-30TT11BE

CONTENTS:

- TT-11BE 30pcs Blue

PB-30TT11RD

CONTENTS:

- TT-11RD 30pcs Red



CBHS-50C

CONTENTS:

- BHS-1.25 20pcs Red
- BHS-2.0 20pcs Blue
- BHS-5.5 10pcs Yellow



TB-4-100

CONTENTS:

- ET4-10 50pcs Orange (Grey is Available)
- ET6-12 20pcs Green (Black is Available)
- ET10-12 20pcs Brown (Ivory is Available)
- ET16-10 10pcs Ivory (Green is Available)

TB-5-400

CONTENTS:

- ET0.75-8 100pcs Blue (White is Available)
- ET0.5-8 50pcs White (Orange is Available)
- ET1.0-8 100pcs Red (Yellow is Available)
- ET1.5-8 100pcs Black (Red is Available)
- ET2.5-8 50pcs Grey (Blue is Available)

※ AVAILABLE IN DIFFERENT QUANTITY / SIZE / COLOR

KSS HEAT-SHRINKABLE TUBINGS



RP-F32-10

CONTENTS:
F32-10 2M Black

RP-F32-10YW

CONTENTS:
F32-10YW 2M Yellow

RP-F32-10GN

CONTENTS:
F32-10GN 2M Green

RP-F32-10RD

CONTENTS:
F32-10RD 2M Red

RP-F32-10BE

CONTENTS:
F32-10BE 2M Blue

RP-F32-10WE

CONTENTS:
F32-10WE 2M White



VS-25

CONTENTS:

K32-3	12.7cm	Black	5pcs
K32-5	12.7cm	Black	5pcs
K32-8	12.7cm	Black	5pcs
K32-10	12.7cm	Black	5pcs
K32-15	12.7cm	Black	5pcs

VS-100

CONTENTS:

K32-1.5	3.5cm	RD, BE, WE, YW	@5pcs
K32-2.5	3.5cm	RD, BE, WE, YW	@5pcs
K32-3.5	3.5cm	RD, BE, WE, YW	@5pcs
K32-5	3.5cm	RD, BE, WE, YW	@5pcs
K32-7	7.5cm	RD, WE	@3pcs BE, YW @2pcs
K32-10	7.5cm	RD, WE, YW	@1pcs, BE 2pcs
K32-13	7.5cm	RD, WE, YW	@1pcs, BE 2pcs

VS-100BK

CONTENTS:

K32-1.5	3.5cm	Black	20pcs
K32-2.5	3.5cm	Black	20pcs
K32-3.5	3.5cm	Black	20pcs
K32-5	3.5cm	Black	20pcs
K32-7	7.5cm	Black	10pcs
K32-10	7.5cm	Black	5pcs
K32-13	7.5cm	Black	5pcs



SP-07-7BK

CONTENTS:
K32-7 12" /PC, 7pcs/bag Black

SP-09-3BK

CONTENTS:
K32-3.5 12" /PC, 9pcs/bag Black

SP-08-5BK

CONTENTS:
K32-5 12" /PC, 8pcs/bag Black

SP-09-357C

CONTENTS:
K32-3.5 12"/PC, 3PCS White
K32-5 12"/PC, 3PCS Red
K32-7 12"/PC, 3PCS Black
(TOTAL 9pcs/bag)

※ 12"=30.5CM

※ AVAILABLE IN DIFFERENT QUANTITY / SIZE / COLOR



	ITEM	Serial NO.	Page	
A	4J/6J/8J	0515	92	
	A	0405	85	
	AC	0910	155	
	AD	0101	15	
	AG	0604	104	
	AGJ	0604	108	
	AGJL	0611	124	
	AGJ-SR	0603	113	
	AGJW	0614	125	
	AGL	0611	124	
	AG-SR	0603	113	
	AGW	0614	125	
	AP	0517	93	
	ARD	0127	31	
	ASTN	0372	79	
	AT	0361	75	
	ATC	0519	94	
	AWS	1216	202	
	B	B-1	0410	85
BC		0915	155	
BCS		1106	178	
BCT		0370	78	
BD		0101	13	
BE		1105	178	
BG		0615	128	
BG-P		0620	129	
BGQ		0616	129	
BMS		1109	180	
BPA		0612	125	
BST		0370	78	
BSTC		0371	79	
BT		1110	181	
BWS		1202	198	
C		CAG	0604	105
		CAP	1351	214
		CATV	0525	96
		CB	0610	124
		CD	0131	35
	CDW	1308	206	
	CE	0801	148	
	CEG	0606	107	
	CE-V0	0801	148	
	CF-P	0621	131	
	CH	0511	90	
	CL	0532	99	
	CM	0230	45	
	CP	0621	132	
	CPW	0621	132	
	CR	0620	131	
	CRS	0620	131	
	CS	1101	174	
	CS	1103	176	
	CSA	1103	176	
	CST	0539	100	
	CTF	0340	73	
	CTT	1205	200	
CV	0301	50		
CVS	0355	75		
CVT	0301	50		
CW	0540	101		
CWP	0511	90		
D	DC	0105	19	
	DCC	0527	97	
	DCI	0105	19/20	

	ITEM	Serial NO.	Page	
D	DCP	0105	19/20	
	DCPT	0105	19/20	
	DCQ	0101	12	
	DCV	0309	59	
	DF	0119	29	
	DH	0513	91	
	DK	0320	68	
	DL	0320	67/68	
	DN	1132	190	
	DNC	1022	171	
	DNF	1012	171	
	DP	0365	77	
	DR	1136	191	
	DR	1204	199	
	DS	1102	176	
	DT	0119	29	
	DV	0309	60	
	E	EB	1108	179
		EBG	0625	134
		EC	0201	38/39
ECA		0201	38	
ECB-1		0201A	39	
ECP		0201	38	
ED		0703	137	
EG		0606	106	
EGHL		0611	124	
EGL		0611	124	
EG-SR		0603	113	
EGW		0614	125	
ELBF		0114	25	
EP		0907	153	
ES		1108	179	
ES	1202	197		
EX	0124	31		
F	FAB	0615	128	
	FAM	0615	128	
	FAP	0615	128	
	FBG	0625	133	
	FC	0520	94	
	FC	0520	95	
	FC	0522	95	
	FC	0530	98	
	FC	0535	99	
	FCP	0535	99	
	FCT	0535	99	
	FCV	0321	69	
	FCW	0535	99	
	FD	0104	14	
	FM	0202	39	
FMR	0208	42		
FR	0731	146		
FZ	0927	159		
G	GD	0101	13	
	GE	0721	143	
	GEC	0721	143	
	GECQ	0721	143	
	GEQ	0721	143	
	GM	0720	144	
	GMC	0720	144	
	GMCQ	0720	144	
	GMQ	0720	144	
	GS	1120	185	
H	HB	0315	62	
	HBW	1307	205	

	ITEM	Serial NO.	Page
H	HC	0505	89
	HC	0510	89
	HD	0101	10
	HD	0101	15
	HGS	1119	184
	HID	0101	14
	HL	1202	197
	HM	0933	162
	HMS	1109	180
	HP	0715	142
	HPA	0735	146
	HPM	0908	153
	HR	0725	145
	HRCV	0316	65
	HS	0920	156
	HTN	1114	183
	HTP	1113	182
	HTS	1111	182
	HV	0315	63
	HVC	0315	64
HVD	0101	11	
J	JD	0118	29
	JDE	0118	29
	JDI	0118	29
	JDL	0118	29
	JDM	0118	29
	JDO	0118	29
	JDT	0118	29
	JWB	1201	194
	JWS	1201	194
	K	K2	0927
K32		0927	159
K34		0927	156
KB		0605	113
KCS		1115	183
KD		0101	10
KFC		0342	73
KFS		0342	73
KG		0701	136
KGC		0701	136
KGH		0701	136
KG-N		0701	136
KL		0402	83
KS		0401	82
KS		0401	83
KSP	0401	82	
KT	0402	83	
KT-1	0705A	138	
KTV	0326	70	
KUC	0503	88	
KVD	0101	11	
KW	0810	150	
KW-N	0810	150	
KWS	1201	194	
KWS	1202	196	
KWS-N	1202	196	
L	LCA	1102	176
	LCH	0514	92
	LCL	1121	186
	LCS	1121	186
	LCS	1121	186
	LD3	1332	209
	LDC	0101	12
	LDT	1331	208

	ITEM	Serial NO.	Page	
L	LE	1321	207	
	LG	1335	210	
	LG3	1334	209	
	LH	1336	210	
	LHK	1339	211	
	LHN	1337	210	
	LK	1322	207	
	LQ	1329	208	
	LQT	1328	208	
	LS	0106	20/21	
	LWS	1204	200	
	LX	1327	207	
	LY	1333	209	
	M	M	0607	110
		M	0607	111
M-1		0420	85	
MAT		0343	74	
MB		0234	45	
MC		0212	43	
MCR		0625	132	
MCS		1101	174	
MCV		0312	61	
MD		0101	10	
MFC		0521	95	
MG		0617	132	
MGT		0350	74	
MGTP		0350	74	
MH		0613	126	
MHVC		0312	61	
MID		0101	14	
MMR		1109	181	
MMS		1109	181	
MNC		1023	172	
MPD	0101	14		
MS	0203	40		
MS	1109	180		
MSP	0716	142		
MT	0210	43		
MV	0905	153		
MWC	0545	101		
N	NBG	0625	133	
	NBGC	0625	134	
	NC	1020	170	
	NC-N	1020	168	
	NF	1005	165	
	NF	1010	165	
	NF	1011	166	
	NF	1011	167	
	NFD	1010	166	
	NFD	1011	167	
	NFP	1011	166	
	NFR	1005	165	
	NFT	1010	165	
	NFT	1010	166	
	NFTT	1010	166	
	NHR2	0927	160	
	NHR4	0927	160	
	NHS	0931	161	
	NJ	1011	166	
	NPT	0608	109	
NPTA	0609	109		
NPTL	0611	124		
NPT-SR	0603	113		
NPTW	0614	125		

	ITEM	Serial NO.	Page
N	NS	1018	169
	NT	1001	164
	NU	1019	169
	NU-N	1020	170
O	OC	0225	44
	OD	0121	30
	OM	0205	40
	OMJ	0207	42
	OMK	0207	41
	OMR	0207	41
	OMT	0207	42
	OP	0113	26
	OPC	0113	26
	OPE	0113	26
	OPI	0113	26
	OPL	0113	26
	OPM	0113	26
	OPO	0113	26
	OPT	0113	26
	OS	0113	25
	OSB	0713	141
	OV	0122	30
P	P	0607	110
	PA	0620	130
	PAO	0620	130
	PAQ	0616	130
	PB	1117	184
	PBG	0625	134
	PB-SM	0236	46
	PC	0502	88
	PCC	1203	198
	PCL	1349	214
	PCT	0330	71
	PCU	1123	187
	PCV	0335	72
	PCVS	0335	72
	PD	0101	14
	PDV	0335	72
	PET-1	0421	86
	PEV	0335	72
	PF	1401	215
	PFS	0516	93
	PFVS	0335	72
	PG	0601	112
	PG	0602	112
	PGV	0335	72
	PH	1151	192
	PHC	0512	91
	PHV	0318	65
	PL	1210	201
	PLD	1345	213
	PLK	1341	211
	PLM	1343	212
	PLR	1347	214
	PLT	1346	213
	PLU	1338	211
	PLW	1344	212
	PLX	1344	212
PMA	0319	66	
PMB	0319	66	
PMT	0314	62	
PN	1401	215	
PP	1030	172	
PPC	0558	102	

	ITEM	Serial NO.	Page	
P	PR	0733	146	
	PRP	0550	101	
	PRVS	0335	72	
	PS	1107	179	
	P-SM	0236	46	
	PSP	0717	143	
	PST	1118	184	
	PSV	0335	72	
	PTS	0518	93	
	PUV	0335	72	
	PVA	0365	76	
	PVF	0365	76	
	PWS	1201	195	
	PWV	0335	72	
	PWVS	0335	72	
	R	RBG	0625	133
		RBL	0125	32
		RBT	0125	32
RC		0528	97	
RCL		0531	98	
RCS		1209	201	
RCV		0316	64	
RD		0125	32	
RDA		0126	33	
RDCV		0309	59	
RDE		0125	32	
RDI		0125	32	
RDL		0125	32	
RDM		0125	32	
RDO		0125	32	
RDT		0125	32	
RH		1204	199	
RHR		0727	145	
RJ45	2001	216		
RJ45-DC1	2002	216		
RLS	1104	177		
RRCV	0321	69		
RS	1104	177		
RSB	0712	141		
RSC	1141	192		
RSD	0130	35		
RSP	1140	191		
RSP	1141	191		
RSTN	0373	80		
RTF	0133	36		
RTFI	0133	36		
RTFL	0133	36		
RTFM	0133	36		
RTFO	0133	36		
RW	1308	205		
RWS	1204	199		
S	SB	0710	140	
	SCA	0909	154	
	SCM	0927	158	
	SCP	0908	154	
	SCS	1106	178	
	SCT	0313	62	
	SD	0101	15	
	SD	0105	16	
	SDB	0105	19	
	SDE	0105	17	
	SDE	0105	19	
	SDH	0105	18	
SDHA	0105	19		

	ITEM	Serial NO.	Page
S	SDHB	0105	19
	SDHF	0105	19
	SDHI	0105	19
	SDHL	0105	19
	SDHO	0105	19
	SDHT	0105	19
	SDHV	0105	19
	SDHX	0105	19
	SDI	0105	17
	SDL	0105	17
	SDM	0105	17
	SDO	0105	17
	SDT	0105	17
	SFC	0530	98
	SGN	0723	144
	SHW	0555	102
	SM	0236	46
	SN	1130	190
	SN	1131	190
	SNB	0425	86
	SP	1102	175
	SPA	1102	175
	SPB	1102	175
	SPC	1102	175
	SPD	1102	175
	SPR	1217	202
	SPS	1116	183
	SR	1125	21
	SR	0705	137
	SR	0707	138
	SR	0708	138
	SR	0708	139
	SR	0709	139
	SR	1125	187
	SR	1126	188
	SR	1127	188
	SR	1128	189
	SR	1129	189
	SRD	0128	34
	SSA3	0927	157
	ST	1205	200
	STV	0327	70
	SW-BH	0808	149
	SWC	0529	98
SWD	0539	100	
SWS	1120	185	
SWT-1	0804	148	
SW-Y	0809	149	
T	TC	0115	27
	TCE	0116	28
	TCI	0116	28
	TCL	0116	28
	TCM	0116	28
	TCO	0116	28
	TCT	0116	28
	TCV	0305	58
	TCVS	0305	58
	TD	0120	30
	TF	0110	23
	TF	0113	24
	TFE	0112	24
	TFI	0112	24
	TFL	0112	24
	TFM	0112	24

	ITEM	Serial NO.	Page
T	TFO	0112	24
	TFT	0112	24
	TG	0302	58
	TH	1301	203
	TH	1302	203
	THR	1301	203
	TL	0330	71
	TMS	1109	180
	TR	1303	204
	TRH	1302	204
	TRW	1311	206
	TS	0518	93
	TT	1212	201
	TTB	1215	202
	TTU	1212	201
	TV	0310	60
	TV	0325	69
	TW	1310	206
TWS	1204	198	
U	UC	0501	88
	UD	0105	15
	UM	0235	45
	USB	0730	145
	USB	0730	146
UY	2005	216	
V	V	0901	152
	VC	0526	96
	VC	0526	97
	VD	0101	11
	VDC	0101	12
VT	0906	152	
W	W3F2	0927	158
	WB	0403	84
	WBS	0403	84
	WBT	0403	84
	WCT	0332	71
	WD	0107	22
	WDE	0108	22
	WDI	0108	22
	WDL	0108	22
	WDM	0108	22
	WDO	0108	22
	WDT	0108	22
	WH	0524	96
	WL	0330	71
	WLT	0330	71
WM	0215	44	
WMB	0215	44	
WR	1305	204	
WR	1306	205	
WS	1202	195	
WT	0101A	11	
Z	ZD	0105	18
	2 HOLES(AG/EG/AGJ/NPT)	0613	114
	3 HOLES(AG/EG/AGJ/NPT)	0613	116
	4 HOLES(AG/EG/AGJ/NPT)	0613	118
	5 HOLES(AG/EG/AGJ/NPT)	0613	120
	6 HOLES(AG/EG/AGJ/NPT)	0613	122
	7 HOLES(AG/EG/AGJ/NPT)	0613	123

MANAGEMENT SYSTEMS & SAFETY CERTIFICATIONS

SGS

KAI SUH SUH ENTERPRISE CO., LTD.
凱士士企業股份有限公司

ISO 9001:2015

IAF

UKAS

SGS

KAI SUH SUH ENTERPRISE CO., LTD.
凱士士企業股份有限公司

ISO 14001:2015

IAF

UKAS

SGS

KAI SUH SUH ENTERPRISE CO., LTD.
凱士士企業股份有限公司

OHSAS 18001:2007

IAF

UKAS

TAF

nqa

Certificate of Registration

KAI SUH SUH ENTERPRISE CO., LTD.
凱士士企業股份有限公司

ISO 9001:2015

nqa

UL Product IQ™

Z00221875Z7 - POSITIONING DEVICES

Positioning Devices

Results Cable Ties Investigated to APPROVAL 62275

Part No.	Part Name	Material	Color	Length	Width	Thickness	Weight	Strength	Temp. Range	UL File #
20001

UL Product IQ™

Z00221875Z7 - POSITIONING DEVICES - COMPONENT

Positioning Devices - Component

Results Cable Ties (Black color) Investigated to APPROVAL 62275

Part No.	Part Name	Material	Color	Length	Width	Thickness	Weight	Strength	Temp. Range	UL File #
20001

UL Product IQ™

NZMT21876T7 - INSULATING BUSHINGS - COMPONENT

Insulating Bushings - Component

Results Cable Ties (Black color) Investigated to APPROVAL 62275

Part No.	Part Name	Material	Color	Length	Width	Thickness	Weight	Strength	Temp. Range	UL File #
20001

UL Product IQ™

ZMV11869T1 - WIRE CONNECTORS AND SOLDERING LUGS

Wire Connectors and Soldering Lug

Results Cable Ties (Black color) Investigated to APPROVAL 62275

KSS 凱士士

Certification Record

Category	Class	File #
Cable Tie

Certification Record

Category	Class	File #
Wire Connector

Certification Record

Category	Class	File #
Wire Connector

DNV-GL

TYPE APPROVAL CERTIFICATE

Results Cable Ties (Black color) Investigated to APPROVAL 62275

KSS 凱士士

Lloyd's Register

Certification Record

Category	Class	File #
Cable Tie

CEPROX

CERTIFICATE OF CONFORMITY

Results Cable Ties (Black color) Investigated to APPROVAL 62275

CE

ABS

CERTIFICATE OF DESIGN ASSESSMENT

Results Cable Ties (Black color) Investigated to APPROVAL 62275

VDE Prüf- und Zertifizierungsinstitut

ZEICHENGENEHMIGUNG MARKS APPROVAL

Results Cable Ties (Black color) Investigated to APPROVAL 62275

VDE



KSS WIRING ACCESSORIES

GENERAL TRADE TERMS :

OUR PRODUCTS ARE WARRANTED TO BE FREE FROM DEFECTS IN MATERIALS AT THE TIME OF SALE BUT OUR OBLIGATION UNDER THIS WARRANTY IS LIMITED TO THE REPLACEMENT OF ANY PRODUCT PROVED TO BE DEFECTIVE WITHIN 3 MONTHS FROM THE DATE OF DELIVERY AND CAN PROVE TO BE THE RESPONSIBILITY OF FACTORY.

NO FURTHER CLAIM, SUCH AS FREIGHT, TAX...ETC. WILL BE ACCEPTED.

BECAUSE OF THE VARIED NATURE OF THE USES OF THESE PRODUCTS EACH USER SHOULD MAKE THEIR OWN EVALUATIONS REGARDING THE SUITABILITY OF THESE PRODUCTS FOR THEIR SPECIFIC APPLICATION.

USER SHALL DETERMINE THE SUITABILITY OF THE PRODUCT FOR HIS INTENDED APPLICATION AND ASSUMES ALL RISKS & LIABILITY WHATSOEVER IN CONNECTION THEREWITH. NEITHER SELLER NOR MANUFACTURER SHALL BE LIABLE FOR ANY INJURY, LOSS, OR DAMAGE, WHETHER DIRECT OR CONSEQUENTIAL, ARISING OUT OF THE USE OF, OR THE INABILITY TO USE, THE PRODUCT.

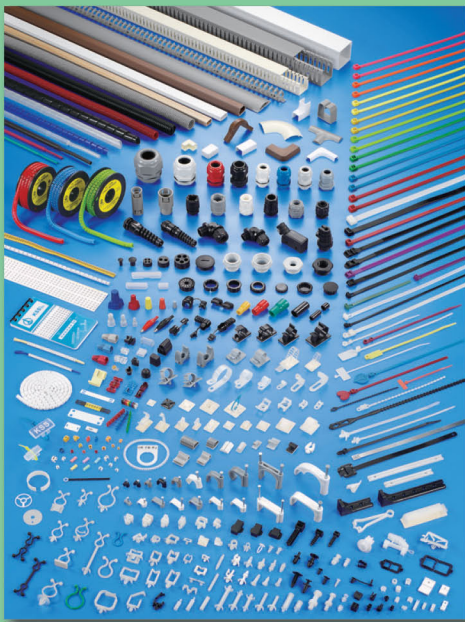

Где купить:
 ООО "КОМПАНИЯ ОПТУЛС"
 г.Москва, ул.Иловайская, д.3, стр.2
 Tel.: +7 (495) 646-00-96
 E-Mail: sale@opttools.ru
 Internet: www.opttools.ru



SINCE 1969

KAI SUH SUH ENTERPRISE CO., LTD.

HEAD OFFICE:

38, YEN PING N. RD., SEC.1 TAIPEI TAIWAN
 TEL: 886-2-2555-1929 (9 LINES)
 FAX: 886-2-2556-0052 (5 LINES)
<http://www.kss.com.tw>
 E-mail:kss@mail.kss.com.tw

TAINAN FACTORY:

23, DU-CHIA, CHI-KU DIST, TAINAN TAIWAN
 TEL: (06) 787-2239 (8 LINES) 787-4636 (3 LINES)
 FAX: (06) 787-4388, 787-1399

TAICHUNG BRANCH OFFICE:

129, KUNG YIH RD., TAICHUNG TAIWAN
 TEL: (04) 2301-1255 (8 LINES)
 FAX: (04) 2302-1313

KAOHSIUNG BRANCH OFFICE:

116, BO AI 1 RD., KAOHSIUNG TAIWAN
 TEL: (07) 323-1488 (10 LINES)
 FAX: (07) 323-3849

FRANCE OFFICE

AUSTRALIA OFFICE

